

# RADIO — ELECTRONICS

Exclusive  
**TELEVISION  
NEWS**

Section

HUGO GERNSBACH, Editor

formerly

**RADIO  
CRAFT**



A HIGH-FIDELITY  
TUNER-AMPLIFIER  
SEE CONSTRUCTION SECTION



**JULY**  
1949

**30¢**

U. S. and  
CANADA

**LATEST IN RADIO — ELECTRONICS — TELEVISION**

[www.americanradiohistory.com](http://www.americanradiohistory.com)

TV EXTRA  
EDITION

# WARD MINUTE MAN



WARD PRODUCTS CORPORATION • 1523 E. 45TH ST., CLEVELAND, OHIO • JULY 1949

## WARD SMASHES TV ANTENNA INSTALLATION COSTS!

IT COSTS ONLY 6c IN LABOR TO ASSEMBLE WARD'S SENSATIONAL MINUTE MAN ANTENNA

(WP) CLEVELAND, OHIO

The Chief Engineer of the Ward Products Corporation states that the new sensational Minute Man antennas are being made of PERMA-TUBE — a newly perfected non-corroding coated steel tubing, created especially for Ward by the Jones and Laughlin Steel Corp., Pittsburgh, Pa. Independent laboratory tests on over 30 metals commonly used for antennas have proved PERMA-TUBE the best for all weather installations. Aluminum is too weak and other types of coated steel corrodes. Ward is the only manufacturer using PERMA-TUBE in constructing antennas. See your Ward Distributor today.



Dick Moss, television engineer, flicks up dipole in assembly operation of Ward Minute Man antennas. (Model TV-46).



A few seconds later and Dick snaps the high frequency dipole into position. It costs only 6c in labor to assemble this Ward Minute Man antenna.

### FLASH!

WARD USES PERMA-TUBE IN CONSTRUCTING MINUTE MAN ANTENNAS.

(WP) CLEVELAND, OHIO

The Ward Products Corporation, a Division of the Gabriel Company, disclosed today their new Minute Man line of TV antennas. These 13 antennas, ranging in list prices from \$2.45 to \$49.95 are completely pre-assembled. Where it formerly took two installation men three-quarters of an hour (or approximately \$7.50 in labor) to assemble the ordinary TV antenna, one man can assemble any Ward Minute Man antenna in a few minutes. This is the greatest technical engineering improvement in the antenna field and the Ward engineers are to be congratulated on its achievement. They have spent many months in their laboratory perfecting the many ingenious construction features. See your Ward distributor today.

GREATER INCOMES AND PROFITS REALIZED BY INSTALLING WARD ANTENNAS.

(WP) NEW YORK, N. Y.

Now you can make big money on a standard installation fee. It has been reported that servicemen and retailers are realizing greater profits by installing Ward Minute Man Antennas. The quick 3 minute installation makes the big difference. It means more installations per day and at greater returns. No consumer complaints have been registered by big labor bills. See your Ward distributor today.

See Your  
Ward Distributor  
Today

### INTRODUCING WARD'S NEW "MINUTE MAN" TV ANTENNAS

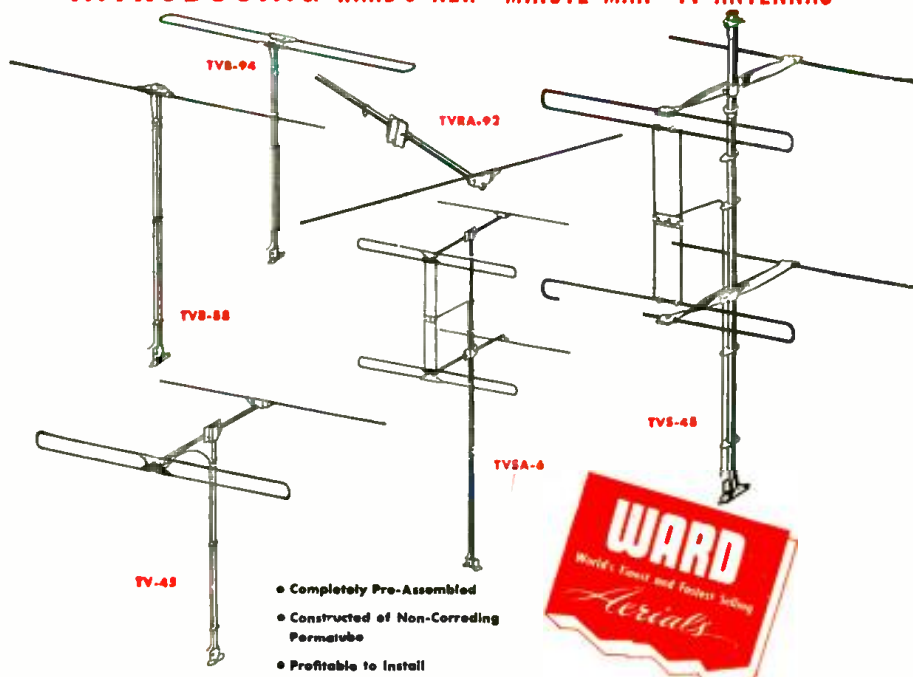

- Completely Pre-Assembled
- Constructed of Non-Corroding Permatube
- Profitable to Install

There are Ward Minute Man Antennas for every purpose and use from any distance from the transmitter. See your distributor today.



# I Will Train You at Home for Good Jobs in **RADIO-TELEVISION**



**I Send You Many  
KITS OF PARTS  
for practical experience**

You conduct many tests and experiments with equipment built from materials I furnish. Some of the equipment from my Servicing Course and some from my Communications Course is shown below. Everything I send is yours to keep.



MODERN RADIO

SET TESTER

TRANSMITTER

WAVEMETER

MULTITESTER

## America's Fastest Growing Industry Offers You **GOOD PAY--SUCCESS**

Want a good-pay job in the fast growing RADIO-TELEVISION Industry? Want a money-making Radio-Television shop of your own? Here's your opportunity. I've trained hundreds of men to be successful Technicians. **MEN WITH NO PREVIOUS EXPERIENCE.** My tested and proved train-at-home method makes learning easy. You learn Radio-Television principles from illustrated lessons. You get practical experience building, testing, experimenting with **MANY KITS OF PARTS** I send. All equipment yours to keep.

### MAKE EXTRA MONEY IN SPARE TIME

The day you enroll, I start sending **SPECIAL BOOKLETS** that show you how to make \$5, \$10 a week or more **EXTRA MONEY** fixing neighbors' Radios in spare time while learning. From here, it's a short step to your own shop or a good-pay Radio-Television servicing job. Or be a licensed Radio-Television Operator or Technician.

### TELEVISION OFFERS BRIGHT FUTURE

Today there are nearly 2700 Radio stations on the air—and within three years experts predict there will be over 1000 Television Stations. Then add developments in FM, Two-Way Radio, Police, Marine, Aviation and Microwave Relay Radio! Think what this means. New jobs, more jobs, good pay for qualified men.

## ACTUAL LESSON **FREE**

Act now! Send for my **FREE DOUBLE OFFER**. Coupon entitles you to actual lesson, "GETTING ACQUAINTED WITH RECEIVER SERVICING." It shows you that learning at home is easy, practical. You also get my 64-page book, "HOW TO BE A SUCCESS IN RADIO-TELEVISION." It tells what my graduates are doing and earning. Send coupon in envelope or paste on penny postal. **J. E. SMITH, President, Dept. 9GX, National Radio Institute, Pioneer Home Study Radio School, Washington 9, D. C.**

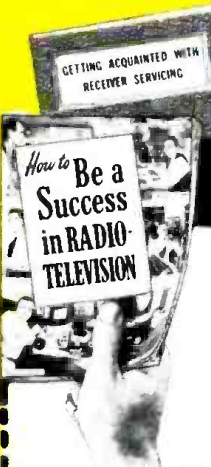

### I TRAINED THESE MEN

"I am operating my own Radio Sales and Service business. With FM and Television in the offing, we have a very profitable future." **A. Patrick, Tampa, Fla.**

"N.R.I. was my stepping stone from a few hundred to over \$4,000 a year as a Radio Engineer. Make extra money servicing Radios." **A. Michaels, Trenton, Ga.**

"Before finishing course, I learned about \$10 a week fixing Radios in spare time. Recommend N.R.I." **W. Strauff, Miami, Florida**

"My first job was obtained for me by your Graduate Service Dept. Am now Chief Engineer, Police Radio Station WQOX, T. Hamilton, Ohio

"Am tied in with two Television outfits, and do warranty work for dealers. Use N.R.I. text often." **Robert Dorman, New Prague, Minn.**

"Four months after enrolling for N.R.I. course, was able to service Radios; averaged \$10-\$15 a week in spare time." **W. R. Weyde, Brooklyn, N. Y.**

"N.R.I. helped me get position as Radio Mechanic with United Airlines. Have Radio-telephone 2nd Class License." **Lehman Hauer, San Bruno, California.**

## Good for Both—**FREE**

**MR. J. E. SMITH, President, Dept. 9GX  
National Radio Institute, Washington 9, D. C.**

Mail me Sample Lesson and 64-page book about How to Win Success in Radio-Television—both **FREE**. (No salesman will call. Please write plainly.)

Name..... Age.....

Address.....

City..... Zone..... State.....

Check if Veteran **Approved Under G. I. Bill**

**VETERANS** GET THIS TRAINING WITHOUT COST UNDER G. I. BILL

# RADIO — ELECTRONICS

formerly RADIO-CRAFT

Incorporating  
SHORT WAVE CRAFT\* TELEVISION NEWS\*  
RADIO & TELEVISION

\*Trademark registered U. S. Patent Office

Circulation Manager Business Manager  
G. Aliquo Charles K. Brett  
Sales Managers  
John J. Lamson, Lee Robinson

Hugo Gernsback, Editor-in-Chief  
Fred Shunaman, Managing Editor  
M. Harvey Gernsback, Consulting Editor  
Robert F. Scott, W2PWW, Technical Editor  
R. H. Dorf, W2QMI, Associate Editor  
I. Queen, W2OUX, Editorial Associate  
Angie Pascale, Production Manager  
Wm. Lyon McLaughlin,  
Tech. Illustration Director

## Contents ————— July, 1949

### Editorial (Page 19)

Biological Electronics .....by Hugo Gernsback 19

### Television News (Pages 20-31)

Reasons and Remedies for TV Interference .....by David Gnessin 20  
How a TV Station Operates .....by Morton Shore 22  
Circuits for Horizontal A.F.C. ....by Louis E. Gorner, Jr. 24  
Television Station List ..... 26  
14-Tube British Televiser .....by Major Ralph W. Hallows 27  
Conditions Affecting TV Image Resolution .....by Nathaniel Rhita 29  
Antennas ..... 30

### Construction (Pages 32-33)

A High-Fidelity Tuner-Amplifier, Part I (Cover Feature) .by M. Harvey Gernsback 32

### Electronics (Pages 34-39)

Electronics in Medicine, Part IX .....by Eugene J. Thompson 34  
Prospecting for Uranium Ore using G-M Counters. ....by Samuel Freedman 36  
I.F. Amplifier in Miniature ..... 38

### Audio (Pages 40-41)

Design Your Own Crossover Network .....by James R. Langham 40

### Servicing (Pages 42-49)

Radio Set & Service Review (Motorola 68F11, 68F12 and 68F14) ..... 42  
Fundamentals of Radio Servicing (Part V—How Capacitors are Made)  
by John T. Frye 44  
Simple Routine Check Locates Receiver Hum...by J. T. Cotardo and S. J. Richard 46  
AM Generator Useful for TV .....by R. M. Vendeland 47  
Two New Aids for TV Antenna Installation ..... 48

### Amateur (Pages 50-53)

Designing Class-AB2 Modulators .....by Rufus P. Turner, K6AI 50  
A.N.L. and Squelch Circuit ..... 51  
A Versatile Grid-Dip Oscillator .....by R. L. Pormenter, W1JXF 52

### Test Instruments (Pages 54-56)

Linear Resistance Bridge .....by I. Queen 54

### Foreign News (Pages 58-60)

European Report .....by Major Ralph W. Hallows 58

### Departments

The Radio Month .....	10	Try This One .....	68
Radio Business .....	16	Miscellany .....	71
New Devices .....	61	Technotes .....	73
Radio-Electronic Circuits .....	62	People .....	75
Question Box .....	64	Communications .....	77
New Patents .....	66	Book Reviews .....	81

**ON THE COVER:** The high-fidelity tuner-amplifier (see p. 32) being checked over by the editor-in-chief's grandson (age 4) while father gets ready to make audio measurements on the amplifier. Kodachrome by Avery Slack.

RADIO-ELECTRONICS, July, 1949, Volume XX, No. 10, Published monthly. Publication Office: Erie Ave., P. O. 3 Streets, Philadelphia 32, Pa. Entered as second class matter September 27, 1948, at the post office at Philadelphia, Pa., under the Act of March 3, 1879. SUBSCRIPTION RATES: In U. S. and Canada, in U. S. possessions, Mexico, South and Central American countries, \$3.50; \$6.00 for two years; \$8.00 for three years; single copies 30c. All other foreign countries \$4.50 a year, \$8.00 for two years, \$11.00 for three years. Allow one month for change of address. When ordering a change please furnish an address stencil impression from a recent wrapper. RADIO-CRAFT PUBLICATIONS, INC., Hugo Gernsback, Pres.; M. Harvey Gernsback, Vice-Pres.; G. Aliquo, Sec'y. Contenta Copyright, 1949, by Radio-Craft Publications, Inc. Text and Illustrations must not be reproduced without permission of copyright owners.

EDITORIAL and ADVERTISING OFFICES, 25 West Broadway, New York 7, N. Y. Tel. REctor 5-9690. BRANCH ADVERTISING OFFICES: Chicago: 308 W. Washington Street, Telephone RAinold 6-7363. Los Angeles: Ralph W. Barker, 1127 Wilshire Blvd., Tel. MA 6-1271. San Francisco: Ralph W. Barker, 582 Market St. Tel. GARfield 1-2481. FOREIGN AGENTS: Great Britain: Atlas Publishing and Distributing Co., Ltd., 18 Brito Lane, Fleet St., London E.C.4 Australia: McGill's Agency, 179 Elizabeth Street, Melbourne. France: Brentano's, 37 Avenue de l'Opera, Paris 2e. Holland: Trillecton, Heemstedeche, Dreef 124 Heemstede, Greece: International Book & News Agency, 17 Amerikla Street, Athens. So. Africa: Central News Agency, Ltd., Cor. Risak & Commissioner Sts., Johannesburg; 112 Long Street, Capetown; 369 Smith Street, Durban. Natal: Universal Book Agency, 70 Harrison Street, Johannesburg. Middle East: Steimatzky Middle East Agency, Jaffa Road, Jerusalem. India: Sunil Gupta (Distributors) Co., Armlta Bazar, Patilka Lt., 14 Ananda Chatterjee lane, Calcutta. Broadway News Centre, Post Bag #5537, Dadar, Bombay #14. K. L. Kannappa Mudalliar, 30 General Patters Road, Mount Road, Madras 2. Pakistan: Paradise Book Stall, Opp. Itgal Cinema, Preeby St., Karachi 3.

Editorial and Executive Offices:

25 West Broadway, New York 7, N. Y.



MEMBER  
AUDIT BUREAU OF CIRCULATION

## Play Safe! Use Reliable TELEVISION REPLACEMENTS

Television requires the most durable, heat-and-moisture-resistant components you can get. In capacitors, that means Sprague. You'll have no profitless call-backs with extra-dependable Sprague TV capacitors.

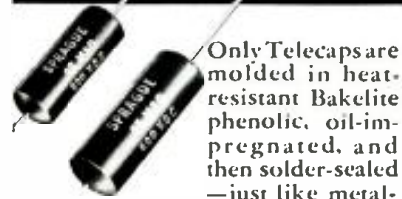

Only Telecaps are molded in heat-resistant Bakelite phenolic, oil-impregnated, and then solder-sealed — just like metal-encased oil-paper capacitors. No other manufacturer can make this claim! Ratings from 600 to 10,000 volts.



The most complete line of television electrolytics. Engineered especially for tough TV replacement applications, Sprague's new Type TVA Atom and Type TVL Twist-Lok electrolytics stand up under the extremely high temperatures, high ripple currents and high surge voltages encountered in TV receivers.

Write for Sprague Bulletin M-429

**SPRAGUE PRODUCTS CO.**  
(Distributors' Division of the Sprague Electric Co.)  
NORTH ADAMS, MASS.

\*Trademark

RADIO-ELECTRONICS for

# The Success Story of Bill Smith... OR YOU!



Mails coupon to National Schools in Los Angeles, and receives Free Lesson and book of information about Radio, Television and Electronics training.



Enrolls... studies in spare time. Finds personal attention from instructors, interesting material and practical equipment, all increase his interest.



Builds actual units as part of Course. Earns money doing spare time repair and installation work.



Completes Course and receives Diploma... is now a qualified Radio, Television and Electronics Technician.



Applies for—and GETS—a good pay, full time job in industry. Finds that employers know National Schools and like to hire their graduates.



Or he opens own profitable Service Shop, with valuable counsel and aid from National Schools. Now for real happiness and success!

## GET INTO RADIO, TELEVISION and ELECTRONICS by NATIONAL SCHOOLS SHOP METHOD HOME TRAINING



You Build This Superheterodyne Receiver With Parts We Send

You receive complete standard equipment, including latest type High-Mu Tubes, for building various experimental and test units. You progress step by step until you build a complete Superheterodyne Receiver. It is yours to use and keep.

### Professional Multitester Included!

This portable instrument (see right) enables you to perform many practical tests, make delicate adjustments and do service work. Complete with test leads.

You receive a series of special laboratory experiment lessons to guide your practical exercises with your equipment. These lessons have been prepared with a special technique of illustrating radio principles by numerous easy-to-understand examples.

Both Resident and Home Study Courses Offered

Send Coupon Today for These Two Valuable Free Books

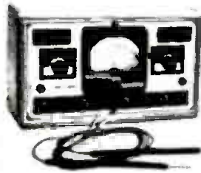

### THIS PRACTICAL, TECHNICAL RESIDENT TRADE SCHOOL TRAINS YOU AT HOME FOR BIG RADIO OPPORTUNITIES!

Never in history has such rapid progress been made as in the great Radio, Television and Electronics Industry today! This exciting, fast-moving development means new and greater opportunities for the trained, skilled man—for you—in Television and Radio Broadcasting, Installing, Servicing; in Frequency Modulation; in Applied Electronics in many industries; in a business of your own!

National Home Training is Practical Your National Schools Course fully covers basic, advanced and specialized instruction in all phases, including basic radio principles, receivers, am-

plifier systems, transmitters, television, aviation radio, electronics. You get complete instruction material, including shop manual, tube manual, job sheets, radio dictionary, special laboratory experiment lessons, experimental equipment. You receive complete, modern television lesson texts.

Your Home Study is supervised by our staff of highly trained instructors who daily teach our resident students here. Let the Free Books shown below tell you more about National Home Training. Use coupon today!

APPROVED FOR VETERANS

### NATIONAL SCHOOLS

LOS ANGELES 37, CALIF. • EST. 1905

FIND OUT NOW... MAIL COUPON TODAY

National Schools, Dept. 7-RE (Mail in envelope or paste on postcard)  
4000 South Figueroa Street  
Los Angeles 37, California

Mail me FREE the book, "Your Future in Radio," and a sample lesson of your course.

NAME..... AGE.....

ADDRESS.....

CITY..... ZONE..... STATE.....

Check here if veteran of World War II

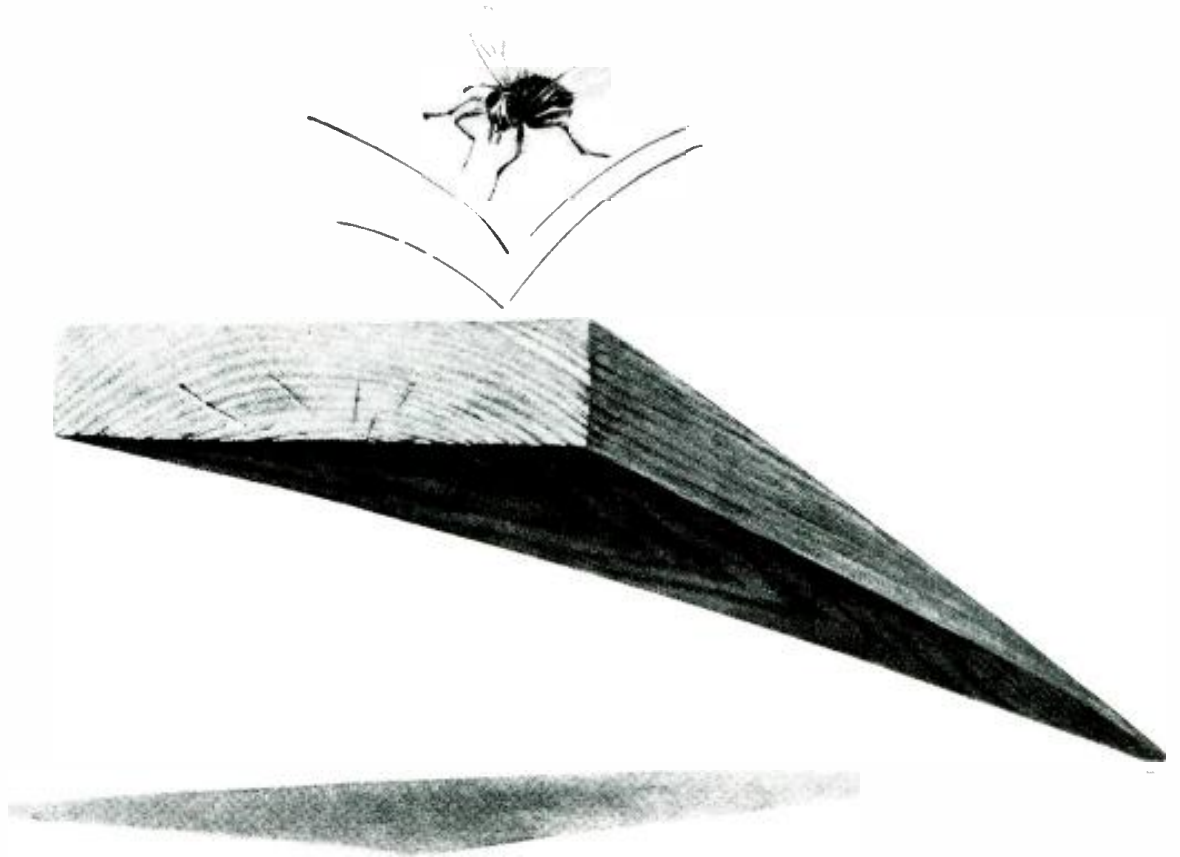

Supersensitive electron tube, developed by RCA, makes possible more accurate measurement of minute vibrations.

## *Can a housefly make a board bounce?*

Surprising though it seems, a fly—when it lands on a board—causes distinct vibrations. They can be detected by a remarkable new RCA electron tube.

Slimmer than a cigarette, and only half as long, RCA's tube picks up vibrations with a pin-sized shaft—and these vibrations may then be converted to visible or audible signals. More important, the new tube can be used to make measurements of the degree of vibration.

Scientists predict many practical uses for this *electronic transducer*. Airplane designers can hitch it to engines or whirling propellers and locate vibrations which might lead to trouble. Oil men can use it to measure the sound waves with which they scout for oil.

And your smooth-running automobile of the future may be an even better car when the facts gathered by RCA's new tube are put to work.

### **Another RCA "first":**

This, the first electronic transducer, is only one research achievement pioneered at RCA Laboratories. Such leadership in science and engineering adds *value beyond price* to any product or service of RCA and RCA Victor.

*Examples of the newest developments in radio, television and electronics can be seen at RCA Exhibition Hall, 36 West 49th St., N. Y. Admission is free. Radio Corporation of America, Radio City, N. Y. 20.*



**RADIO CORPORATION of AMERICA**

*World Leader in Radio — First in Television*

RADIO-ELECTRONICS for

# Which Job for YOU next year?



## NO VISION OR TELEVISION

### Get on the TV Band-Wagon Now!

**Don't let the lack of vision keep you behind the progress parade. Be alert to the opportunities—the good paying jobs—the secure future that Television offers!**

Prepare NOW for the interesting and profitable jobs awaiting trained television engineers and technicians. CREI offers you a proved program of on-the-job training that can provide you with the technical ability to step ahead of competition and get a good-paying Television position.

Sooner or later you *must* face Television—as a *problem*, or as an *opportunity!* You can make your own opportunity by preparing yourself *now*. CREI can show you the way with convenient spare-time study that gives you the up-to-the-minute technical ability you must have for Television!

CREI courses are designed to give you a thorough grounding in basic principles and take you

**VETERANS: CREI TRAINING AVAILABLE UNDER G.I. BILL. FOR MOST VETERANS JULY 25, 1951, IS THE DEADLINE — ACT NOW!**

If you have had professional or amateur radio experience and want to make more money, let us prove to you we have the training you need to qualify for a better radio job. To help us answer intelligently your inquiry—*please state briefly your background of experience, education and present position*



## Capitol Radio Engineering Institute

An Accredited Technical Institute Founded in 1927  
Dept. 147-A, 16th and Park Road, N. W., Washington 10, D. C.  
Branch Offices: New York (7) 170 Broadway • San Francisco (2) 760 Market St.

step-by-step through the more advanced subjects of TV and its related fields. Because all *new* electronic developments are based on *past* techniques, your own radio experience becomes doubly important when coupled with modern CREI training. You will find the CREI study program basic and helpful right from the very start. You will learn about and understand such subjects as: Optics, Pulse Techniques, Deflection Circuits, RF, IF, AF and Video Amplifiers; FM; Receiving Antennas; Power Supplies; Cathode Ray; Iconoscope; Image Orthicon and Projection Tubes; UHF Techniques, Television Test Equipment, etc.

Get in and *get ahead* in Television. One industry leader predicts *12 Million* TV sets by 1953. This means hundreds of stations, millions of listeners and countless opportunities for the right men to fill the good positions in every phase of the industry. The facts are available to you *now*. Mail the coupon for complete details. The cost is *popular*. The terms are *easy*. The information is *free*. Write today.

### MAIL COUPON FOR FREE BOOKLET

**CAPITOL RADIO ENGINEERING INSTITUTE**  
16th & Park Road, N. W., Dept. 147-A, Washington 10, D. C.

Gentlemen: Please send your free booklet, "Your Future in the New World of Electronics," together with full details of your home-study training. I am attaching a brief resume of my experience, education and present position.

Check field of greatest interest:

- PRACTICAL RADIO ENGINEERING
- AERONAUTICAL RADIO ENGINEERING
- BROADCAST RADIO ENGINEERING (AM, FM, TV)
- PRACTICAL TELEVISION ENGINEERING
- TELEVISION, FM & ADVANCED AM SERVICING
- ADVANCED ELECTRONICS COMMUNICATIONS
- RADIO-ELECTRONICS IN INDUSTRY

NAME \_\_\_\_\_

STREET \_\_\_\_\_

CITY \_\_\_\_\_ ZONE \_\_\_\_\_ STATE \_\_\_\_\_

I AM ENTITLED TO TRAINING UNDER G. I. BILL.

RADIOMEN'S HEADQUARTERS WORLD WIDE MAIL ORDER SERVICE!

\$9.95 TAKES ALL THREE BIG BARGAINS "B"

HOME WORKSHOP AT BARGAIN PRICE. Accurate and precise 2 speed guaranteed hobby lathe...



STROMBERG CARLSON Power Switching Relay Box. Neat 3 1/2 x 4 5/8 x 1 1/2 inch steel case with tight fitting cover finished in Stromberg's usual beautiful chocolate color crackle finish.

RT-1655 tube crystal controlled SUPERHET RECEIVER that covers the FM band. The ultra modern circuit uses a fraction of the number of tubes.



6.95 TAKES ALL THREE BIG BARGAINS "E"

1. AUDIO AMPLIFIER—Brand new push-pull output triode amplifiers having 2 of the valuable and scarce output tube audio transformers that sell for over \$10.00 apiece.

2. BANDSWITCHING TUNING TURRET made by Western Electric. Covers 4 bands above 100 MC. All coils wound with #14 silver-plated wire.

3. CARBON MIKE with Push-To-Talk Switch and Gold Plated Carbon Lapel Mike. Combination offer on both mikes.

OUR PE-109 DIRECT CURRENT POWER PLANT

This power plant consists of a gasoline engine that is rated at 2000 watt 22 volt DC power plant. This unit is ideal for use in the field as it is a very ideal for commercial power or for use in the surplus items that require 24-32 DC for operation.



AUTO RADIO DEALERS! ATTENTION!

Nationally advertised brand of 1949 car radio which will fit practically any car and every pocketbook. Super-heterodyne with 6 1/2 speaker.

BUFFALO RADIO SUPPLY 219-221 Genesee St., Dept. RE-3, BUFFALO, N. Y.

SPEAKERS—These PM speakers are the finest that are available. All have heavy oversize Alnico V magnets. 3 1/2" ... \$1.15 ... 6 for \$6.60 4" ... \$1.15 ... 6 for \$6.60 5" ... \$1.50 ... 6 for \$8.70 6" ... \$1.50 ... 6 for \$8.70 6"x4" Oval ... \$2.10 ... 6 for \$10.80 7" (Car Radio Size) \$4.50 ... 6 for \$21.50 8" ... \$3.95 ... 6 for \$20.50 10" ... \$4.95 ... 6 for \$28.50 12" ... \$5.50 ... 6 for \$30.00 12" ... \$7.95 ... 6 for \$42.00

DELUXE SUPERHET A.C.-D.C. RADIO KIT. Extra high quality standard production line radio in kit form with complete instructions.

\$7.05 TAKES BARGAIN "C"

ALUMINUM GEAR BOX INH47 that contains two powerful electric motors and two matched gear trains.

SIGNAL CORP. INTER-CONNECTOR RELAY BOX 730A. This valuable unit, made by Bell, and more familiarly known by the U. S. Army designation BC619, is enclosed in a highly polished aluminum case.

REMOTE CONTROL UNIT—Aluminum case 3 1/2 x 3 1/2 x 2 containing 2 potentiometers, triple pole switch, 4 knobs, phone jack, rear mechanism and re-connection counter.

1949 MODEL MUTUAL CONDUCTANCE TUBE TESTER \$52.95

No possibility of good tubes being read "Bad" or bad tubes reading "Good" as on dynamic conductance testers. On this unit, containing emission testers. Attractive panel and ease equal to any on the market in appearance.

FCC AUTHORIZES RADIO FOR PRIVATE SERVICE!!!!

(The FCC announced that effective June 1, any American over 17 years of age is eligible for a 5 year station permit. In the "Citizens" band, neither code test nor technical knowledge is necessary.)

VACUUM TUBE VOLT-OHM-CAPACITY METER

There are many features engineered into this all purpose instrument that make it an instrument on the market regardless of price.

- 5 inch easy to read meter. DC voltage ranges from 0 to 1000 V (input resistance as high as 1 megohm per volt.) AC voltage ranges from 0 to 1000 V (No dry disc rectifier to age and destroy the accuracy of this VACUUM TUBE VOLTMETER.) Resistance ranges from 2 1/2 MHO to 1000 megohms. Capacity ranges from .00025 to 20 MFD. A zero center range for balancing the circuit. Isolating resistor built into probe. Standard natural finish hard wood case.



1000 CYCLE AUDIO FILTERS

Navy PD52010-1 low pass audio filters as mentioned in the "Peaked Audio" article in June CQ, and designated by the above number, are the exact electrical and physical equivalent of commercial audio filter units selling for \$35.00 wholesale.

RT 1579 with tubes diagram and parts list only \$14.95

A three stage, cascade 6SJ7 and 6F6 output stage high gain, high fidelity amplifier with 60 cycle, 110 v. power supply on the same 13 1/2 x 4 1/2 chassis, which is protected by a substantial steel cover over tubes and parts.

S.R-274N COMMAND SETS THE GREATEST RADIO VALUE IN HISTORY!!!

A mountain of valuable equipment that includes not 1 but 3 of the finest superhet communications receivers, each of which has a tuned R.F. stage, 3 gang condenser, crystal, and 6 working tubes not counting rectifiers. Also included are 2 Tuning Control Boxes-1 Antenna Coupling Box with R.F. meter to measure power fed into antenna.

COMPRESSED AIR INSTANTLY, ANYWHERE!!!

Portable Air Compressor and storage tank. Rigidly built of best materials using lifetime lubricating ball-bearing on connecting rod and oil impregnated main bearing on shaft.



Patented unique air intake system increases efficiency tremendously over other compressors so that air output is much greater than that from larger compressors powered by heavier motors.

SELENIUM RECTIFIERS

(May be used at any voltage lower than rating) 1.2 ampere ... 30 Volt ... \$ .90 (cathode connected for battery charging)

CERAMIC INSULATED VARIABLE AIR CONDENSERS

350 mmd. 5 gang—\$1.95; 4 gang—\$1.49; 3 gang—\$1.29 10 mmd. 3.35-10 for \$2.90 100 for \$23.00 15 mmd. 3.35-10 for \$2.90 100 for \$23.00 23 mmd. 3.35-10 for \$2.90 100 for \$23.00 35 mmd. 3.45-10 for \$3.40 100 for \$28.00 50 mmd. 3.45-10 for \$3.70 100 for \$30.00 75 mmd. 3.45-10 for \$4.40 100 for \$38.00 100 mmd. 3.55-10 for \$4.50 100 for \$38.00 140 mmd. 3.80-10 for \$7.40 100 for \$64.00 160 mmd. 3.80-10 for \$8.50 100 for \$70.00 2 Gang 140 mmd. \$1.60-10 for \$12.50 100 for \$100.00

PORTABLE ELECTRIC DRILL TERRIFIC VALUE ONLY \$20.95

Equipped with 1/2" Jacobs Gears Chuck and Key Not an intermittent duty drill, but a full size rugged tool. Most convenient type switch, manual gear handle, and balance like a six-shooter.

1-14 H. P. AC or DC electric motor dynamometer

1-14 H. P. AC or DC electric motor dynamometer conversion complete with cord & plug ready to run. A super buy at \$29.50. Battery type B438, 103.5v. battery used in hand held detectors. 151X113—Omitted but test OK. \$1.98 Standard type normally open MICROWAVE SWITCHES \$1.99 leaf actuator SPDT MICRO SWITCHES \$1.49 Brand new fully automatic 400 cycle single button mike transformer in beautiful silver finish case. \$3.95 Television 300 ohm twinline, per 300 ft. \$9.95 Miniature bayonet pilot light sockets per hundred. \$1.95 Universal 2 lead broadcast band oscillator coil (can be converted to 3 lead type by addition of bumper). \$1.60 Brand new motor driven band switching turret (slit slotted) 2 1/4 inch coils with ceramic forms and air trimmers. 100 to 110 MC. A steal at \$2.95





TELEVISION WILL BE THERE..WILL YOU?

# TELEVISION

## RADIO • ELECTRONICS

OUR GREATEST OFFER IN 17 YEARS

### • BULLETIN!

Fires, Sporting Events, Major happenings and other news events are being covered by Television Camera Crews in a growing number of areas. Let us show you how to prepare to enter the profitable and exciting technical phases of Television, Radio, Electronics. Mail coupon. Get Free information about our greatest offer in 17 years.

### Send for FREE Information

See HOW—in your own home—DeForest's Training, Inc., now brings you one of today's most complete combinations of major home training aids. You (1) Learn-by-Seeing from D.T.I.'s exclusive instructive Home Movies. You (2) Learn-by-Reading from well-illustrated lessons. And (3), you set up your own HOME LABORATORY where you Learn-by-Doing from 16 shipments of Radio-Electronic parts which you use and KEEP to work over 300 instructive...fascinating projects. This includes building the valuable 6 tube "Superhet" RADIO and commercial-type OSCILLO-SCOPE, R-F SIGNAL GENERATOR, and Jewel-Bearing MULTIMETER, pictured at right. You may use this test equipment to help you earn real money—both in your spare time and later when working full time in the field either in a good job or your own business. Get complete facts. Mail coupon today!

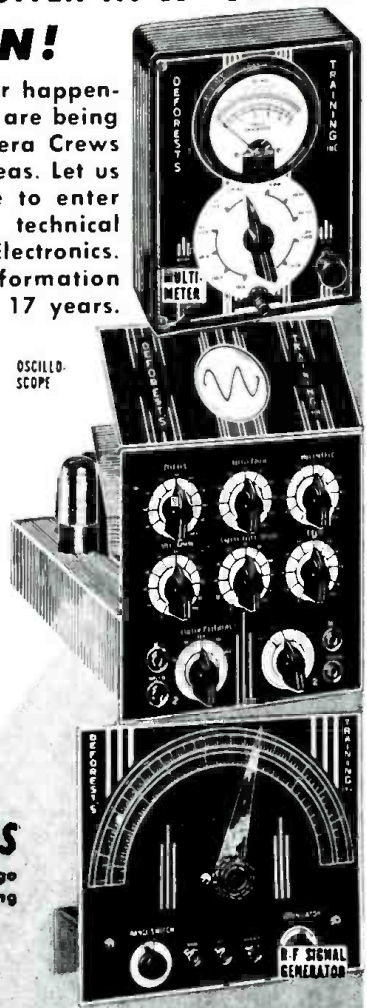

### EMPLOYMENT SERVICE

When you complete your training, our effective Employment Service is available to you without extra cost—a valuable aid to help you get started.

### MODERN CHICAGO LABORATORIES

If you prefer, you can get ALL your preparation in our new Chicago training laboratories—among the finest of their kind. Train quickly, using a wide variety of commercial equipment...ample instructors...every major training advantage. Write for details.

### You also use HOME MOVIES!

...a D. T. I. Exclusive!... D. T. I., alone, includes the use of one of today's most effective training aids...MOVIES...to help you learn important fundamentals faster, easier at home. See electrons on the march, and other fascinating "hidden action"—a remarkable home training advantage that speeds your progress.



6-TUBE RECEIVER

YOU BUILD AND KEEP THIS EQUIPMENT TO WORK OVER 300 HOME EXPERIMENTS.

### MAIL THIS OPPORTUNITY COUPON NOW!

DeForest's Training, Inc.  
2533 N. Ashland Ave., Dept. RC-F7  
Chicago 14, Illinois

Please give me complete facts showing how I may prepare to make my start in Television-Radio-Electronics.

Name \_\_\_\_\_ Age \_\_\_\_\_  
Street \_\_\_\_\_ Apt. \_\_\_\_\_  
City \_\_\_\_\_ Zone \_\_\_\_\_ State \_\_\_\_\_

## DeFOREST'S TRAINING, INC.

CHICAGO 14, ILLINOIS

Affiliated with the DeVry Corporation, Builders of Electronic and Movie Equipment

**NATIONAL**  
TELEVISION



Model TV-7M

**5**

**REASONS WHY  
IT'S A  
BETTER  
BUY**

(1) Built, not assembled, by the leading maker of precision amateur and commercial radio receivers using quality NATIONAL components. (2) Exclusive Binaural Sound, using two speakers, does justice to FM. (3) Unique 37 mcs. IF minimizes interference. (4) Extra sensitivity brings in clear, bright pictures even in remote areas. (5) Records prove NATIONAL gives more trouble-free entertainment.

7-inch picture tube. Straight AC power supply (higher voltage). In handsome, durable metal cabinet at your National dealer's.

**\$179<sup>50</sup>**

**National**  
EST. 1914  
**NATIONAL COMPANY, Inc.**  
MALDEN, MASSACHUSETTS

**CLINTON B. DESOTO**, technical editor of the *Proceedings of the IRE* died on April 27th at the age of 37. He was prominent in both engineering and amateur fields, having been editor of *QST* before joining the staff of the Institute of Radio Engineers.



Mr. DeSoto secured his amateur license in 1926 and became an assistant secretary of the American Radio Relay League in 1930. In 1936 the ARRL published his history of amateur radio, "Two hundred Meters and Down." A second volume, "Calling CQ," was published just before the war.

In 1942, Mr. DeSoto became editor of *QST*, for which he had written many articles during his 16 years with the ARRL. On April 1, 1946 he left ARRL to assume the editorship of the *Proceedings*.

**COLOR TELEVISION** demonstrations will be resumed by CBS in New York City, the network announced last month. Using the mechanical color-scanning system developed by the company some time ago, a new transmitter atop the Chrysler Building will radiate color transmissions with power of 20 kw on a frequency of 490 mc.

**TV SATELLITE STATION** was authorized by the FCC last month on application of NBC. The network will operate the station near Bridgeport, Conn., to pick up the low-band signals of WNBT, New York, and rebroadcast them on about 529 mc.

The organization's apparent purpose in the operation is two-fold—to observe receiver operation, with the idea that these u.h.f. receivers may be the first in a new line to be manufactured by parent company RCA; and to obtain data on u.h.f. propagation. NBC's u.h.f. TV experiments in Washington last year were marred by tube failures due to excessive heat generated. The difficulty is expected to be cleared up in the new installation by use of a cluster of tubes developing about a kilowatt. A high-gain radiator array will boost effective power to between 15 and 20 kw.

**TWO NEW CHANNELS** for television were added last month to the coaxial-cable service between New York and Chicago. With the cables inaugurated in January—one channel in each direction—four channels are now available, three westbound and one eastbound. Two westbound channels are available for television at all times, the third only after 6 p.m. and holidays.

**TV PROTECTS WORKERS** at Army ordnance depots, Major General James Kirk announced last month. Aiding men engaged in work with high explosives, television cameras are placed in position to pick up images of the explosives and transmit them to workers safely hidden behind concrete barriers. The workers manipulate the explosive devices by remote controls, watching their work on the television screen.

**TELEVISION JOBS** number one-tenth as many as those in FM and AM combined, the National Association of Broadcasters revealed last month. According to an NAB survey, 3,456 full-time and 1,000 part-time and free-lance employees were working for the 57 TV stations on the air in February, in addition to talent employed directly by program and advertising agencies. An estimated 50% of a TV station's staff is in the technical department, 4% in sales, 22% in the program department, 16% in "general administration," and 8% in the film department.

Individual station payrolls average \$4,310 a week; network operations in New York average \$29,500. About 32% of stations employ less than 30 persons regularly but 13% have staffs of more than 70.

**LICENSING BILL** providing that no person may install, service, or repair a television receiver without a license was introduced in the Illinois General Assembly recently. To obtain a license a repairman would, if the bill were passed, have to attend a television school course of at least 36 weeks duration and also pass a state examination. The bill is so worded as to prevent even set owners from working on their own receivers and would, if interpreted strictly, prevent the construction of kit receivers by unlicensed persons.

**PRICE REDUCTIONS** on cathode-ray television tubes were announced last month by two manufacturers. RCA and Sylvania have lopped 10% off the charges for their 10-inch tubes; Sylvania's decrease in the price of the 12½-inch tube is another 10%, bringing reduction total on this tube to 20% since April 6th. Increased manufacturing facilities and improved techniques are credited for the cost downgrading.

**FLYING BOMBS** weighing 12,000 pounds and capable of being guided all the way to a target will be ready within a year, Gen. Joseph T. McNarney, chief of the Air Force's Air Materiel Command predicted last month.

## FCC ALLOCATIONS CHANGES

and rules governing mobile and non-broadcast radio services between 25 and 460 mc were announced in Public Notice No. 35,345 dated May 3, 1949. The changes become effective on July 1, 1949. Changes announced in this notice affect the following old major service categories: Experimental General Mobile Radio, Emergency Radio Service, Miscellaneous Radio Service, Utility Radio Service, and Railroad Radio Service. All of these old services have been absorbed by four new major categories: Land Transportation Radio Services, Domestic Public Mobile Radio Service, Industrial Radio Services and Public Safety Radio Services. The Maritime Mobile Service is retained under the new regulations and is assigned 12 frequencies in the 152-162 mc band.

The Experimental General Mobile Radio classification has been superseded by three new major categories:

**Land Transportation Radio Services** is the group including the following:

*Taxicab and Railroad Radio Services* are familiar to most readers.

*Highway Truck Radio Service* is used by persons and organizations regularly engaged in operating trucks on routes outside metropolitan areas.

*Intercity Bus Radio Service* authorizations apply to common carriers operating on public highways between established city terminals.

*Urban Transit Radio Service* covers persons or organizations offering common-carrier service over fixed routes within communities.

*Automobile Emergency Radio Service* rules permit public garages and associations of private automobile owners to operate mobile equipment to speed the dispatch of emergency road service.

**Domestic Public Mobile Radio Service**, the second of the new categories, is designed to furnish communication service for hire between fixed and mobile stations on land.

**Industrial Radio Services**, the third new category, covers the following sub-services: Power, Petroleum, Forest Products, Motion Picture, Relay Press, Special Industrial, and Low Power Industrial Radio Services.

*Special Industrial* permits will be granted only to persons engaged in construction, fabrication, and manufacturing.

*Relay Press* will provide complete mobile radio service. Formerly uses of this service were restricted to walkie-talkie-type equipment between the scene of the news event and a reporter at the nearest telephone. Radio facsimile transmission of photographic material from any mobile units will not be permitted on any mobile service frequency in the v.h.f. bands. Experimental operation of such equipment is permitted on available bands above 952 mc.

**Public Safety Radio Services** is a new category that replaces Emergency Radio Service. This provides rules governing Police, Fire, Forestry-Conservation, Highway Maintenance, and Special Emergency Radio Services.

New allocations for Land Transportation Radio Services are:

*Railroad Radio Service*: forty-one of the 47 channels in the 152-162-mc band have been assigned to the 32 railroads operating in and out of Chicago, and 39 have been assigned to railroads in areas outside that city. Channels assigned outside Chicago may be shared by Public Safety in areas where they cause no interference to the railroads. Eight developmental frequencies have been assigned in the 450-460 mc band on a shared basis with Urban Transit.

*Taxicab Radio Service* retains the original 152.27- and 157.53-mc allocations and gains six frequencies in the 152-162-mc band. The frequencies are in two blocs, each having four adjacent channels.

*Highway Truck Radio Service* is assigned seven frequencies in the 30-40-mc band.

*Intercity Bus Radio Service* has 16 frequencies in the 30-44-mc band.

*Urban Transit Radio Service* has seven exclusive frequencies in the 44-50-mc band, 13 in the 30-44-mc band on shared basis with other services, and shares eight developmental frequencies with *Railroad Radio* in the 450-460-mc band.

*Automobile Emergency Radio Service* has one exclusive frequency in the 30-44-mc band and two exclusive developmental channels in the 450-460-mc band.

**Domestic Public Mobile Radio Service** has been allocated 24 frequencies in the 30-44-mc band and 20 in the 152-162-mc band. In addition, the rules provide four frequencies in the 35-44-mc band for Western Union's Telecar pickup and delivery service now operating in Baltimore, Md.

**Industrial Radio Service** channels far outnumber those set aside for any other type of service. Allocations are: 16 usable frequencies between 25 and 30 mc, 58 between 44 and 50 mc, 23 between 152 and 162 mc, four between 173.2 and 173.4 mc, two megacycles of space in the 450-460-mc band, and shared use of a number of microwave bands.

*Relay Press Service* will share four frequencies in the 162-174 mc band with *Motion Picture Service* and will share 20 frequencies in the 450-460-mc band with other industrial services.

*Remote Pickup (or Relay Broadcast)* shares nine of the available 14 channels in the 152-162-mc band with industrial services.

**Public Safety Radio Services** have exclusive frequency allocations in the 44-50-mc band.

**Police Radio** lost some frequencies in the 152-162 mc band but has gained an equal number of exclusive frequencies in the 158-159-mc band.

*Forestry Conservation Service* has four exclusive frequencies in the 152-162-mc band and nine channels between 170 and 173 mc.

*Highway Maintenance Radio Service* has exclusive frequencies in the 44-50-mc band and the 152-162-mc band can be used on a shared basis.



## "A" BATTERY ELIMINATORS



### for DEMONSTRATING AND TESTING AUTO RADIOS

New Models . . . Designed for testing D. C. Electrical Apparatus on Regular A. C. Lines. Equipped with Full-Wave Dry Disc Type Rectifier, Assuring Noiseless, Interference-Free Operation and Extreme Long Life and Reliability.



### AUTO RADIO VIBRATORS

A Complete Line of Vibrators . . . Designed for Use in Standard Vibrator-Operated Auto Radio Receivers. Built with Precision Construction, featuring Ceramic Stack Spacers for Longer Lasting Life.

NEW MODELS ✓ NEW DESIGNS ✓  
NEW LITERATURE ✓  
ATR "A" Battery Eliminator, DC-AC Inverters, Auto Radio Vibrators  
See your jobber or write factory

AMERICAN TELEVISION & RADIO CO.  
Quality Products Since 1931  
SAINT PAUL 1, MINNESOTA-U.S.A.

# Heathkit TUBE CHECKER KIT

# Heathkit TEST



SHIPPING  
WT. 15 LBS.

**\$29.50**

### Features

1. Measures each element individually.
2. Has gear driven roller chart.
3. Has lever switching for speed.
4. Complete range of filament voltages.
5. Checks every tube element.
6. Uses latest type lever switches.
7. Uses beautiful shatterproof full view meter.
8. Large size 11"x14"x4" complete.

Check the features and you will realize that this Heathkit has all the features you want. Speed—simplicity—beauty—protection against obsolescence. The most modern type of tester—measures each element—beautiful Bad-Good scale, high quality meter—the best of parts—rugged oversize 110 V. 60 cycle power transformer—finest of Mallory switches—Centralab controls—quality wood cabinet—complete set of sockets for all type tubes including blank spare for future types—fast action gear driven roller chart uses brass gears to quickly locate and set up any type tube. Simplified switching cuts necessary time to minimum and saves valuable service time. Short and open element check. No matter what arrangement of tube elements, the Heathkit flexible switching arrangement easily handles it. Order your Heathkit Tube Checker today. See for yourself that Heath again saves you 2/3 and yet retains all the quality—this tube checker will pay for itself in a few weeks—better build it now. Complete with detail instructions—all parts—cabinet—roller chart—ready to wire up and operate.

## New Heathkit TELEVISION ALIGNMENT GENERATOR KIT

Everything you want in a television alignment generator. A wide band sweep generator covering all FM and TV frequencies—a marker indicator—AM modulation for RF alignment—variable calibrated sweep width 0.30 Mc.—mechanical driven inductive sweep. Husky 110 V. 60 cycle power transformer operated—step type output attenuator with 10,000 to 1 range—high output on all ranges—band switching for each range—vernier driven main calibrated dial with over 45 inches of calibrations—vernier driven calibrated indicator marker tuning. Large grey crackle cabinet 16-1/8" x 10-5/8" x 7-3/16". Phase control for single trace adjustment. Uses four high frequency triodes plus 5Y5 rectifier—split stator tuning condensers for greater efficiency and accuracy at high frequencies—this Heathkit is complete and adequate for every alignment need and is supplied with every part—cabinet—calibrated panel—all coils and condensers wound, calibrated and adjusted. Tubes, transformer, test leads—every part with instruction manual for assembly and use. Actually three instruments in one—TV sweep generator—TV AM generator and TV marker indicator. Also covers FM band.

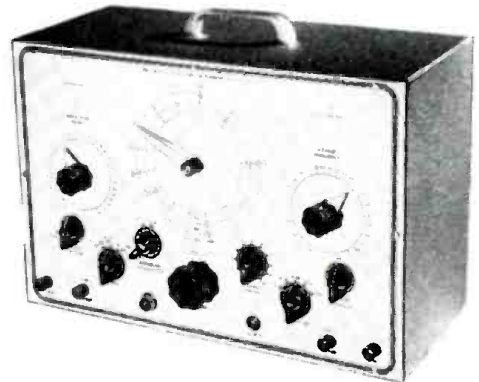

**\$39.50**

## Heathkit SINE AND SQUARE WAVE AUDIO GENERATOR KIT

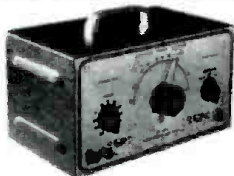

**\$34.50**  
Nothing  
ELSE TO BUY

Experimenters and servicemen working with a square wave for the first time invariably wonder why it was not introduced before. The characteristics of an amplifier can be determined in seconds compared to several hours of tedious plotting using older methods. Stage by stage, amplifier testing is as easy as signal tracing. The low distortion (less than 1%) and linear output ( $\pm$  one db.) make this Heathkit equal or superior to factory built equipment selling for three or four times its price. The circuit is the popular RC tuning circuit using a four gang variable condenser. Three ranges 20-200, 200-2,000, 2,000-20,000 cycles are provided by selector switch. Either sine or square waves instantly available at slide switch. All components are of highest quality, cased 110 V. 60 cycle power transformer, Mallory F.P. filter condensers, 5 tubes, calibrated 2 color panel, grey crackle aluminum cabinet. The detailed instructions make assembly an interesting and instructive few hours. Shipping Wt., 13 lbs.

## New Heathkit FM TUNER KIT

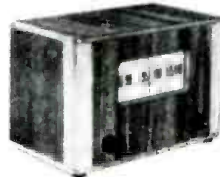

**\$14.75**  
CABINET  
EXTRA

A truly fine FM Tuner with the coils ready wound, all alignment completed—all that is necessary is wiring and it's ready to play—uses super regenerative circuit—110 V. 60 cycle transformer operated—two gang tuning condenser—slide rule—calibrated dial—two tubes—complete instructions including pictorial enable even beginners to build successfully.

The circuit uses twin triode and is extremely powerful—pulls in stations far beyond normal expectations. Shipping Wt., 4 pounds.

Beautiful mahogany cabinet for FM Tuner (shown above) extra..... **\$3.75**

## Heathkit CONDENSER CHECKER KIT

**\$19.50**  
Nothing  
ELSE TO BUY



### Features

- Bridge type circuit
- Magic eye indicator
- 110 V transformer operated
- All scales on panel
- Power factor scale
- Measures resistance
- Measures leakage
- Checks paper-mica-electrolytics

Checks all types of condensers, paper-mica, electrolytic-ceramic over a range of .00001 MFD to 1000 MFD. All on readable scales that are read direct from the panel. NO CHARTS OR MULTIPLIERS NECESSARY. A condenser checker anyone can read without a college education. A leakage test and polarizing voltage for 20 to 500 volts provided. Measures power factor of electrolytics between 0% and 50%. 110 V. 60 cycle transformer operated complete with rectifier and magic eye tubes, cabinet, calibrated panel, test leads and all other parts. Clear detailed instructions for assembly and use. Why guess at the quality and capacity of a condenser when you can know for less than a twenty dollar bill. Shipping Wt., 7 lbs.

## New Heathkit TOOL KIT



Now a complete tool kit to assemble your Heathkit. Consists of Krauter diagonal cutters and pointed nose assembly pliers, Xcelite screwdriver, 60 Watt 110 V. soldering iron and supply of solder. Shipping Wt., 2 lbs. Complete kit..... **\$5.95**



10,000 V H.V. Test Probe Kit No. 310. Extends range of any 11 megohm VTVM to 3,000 and 10,000 Volt ranges. A necessity for television. Ship. wt., 1 lb. **\$4.50**

RF Crystal Test Probe Kit No. 309. Kit to assemble. RF probe extends VTVM range to 100 MC. Complete with IN34 crystal. Shipping weight, 1 lb..... **\$6.50**



The **HEATH COMPANY**

... BENTON HARBOR 20, MICHIGAN

# EQUIPMENT and accessories

## New Heathkit BATTERY ELIMINATOR KIT

Now a bench 6 Volt power supply kit for all auto radio testing. Supplies 5-7½ Volts at 10 Amperes continuous or 15 Amperes intermittent. A well filtered rugged power supply uses heavy duty selenium rectifier, choke input filter with 4,000 MFD of electrolytic filter. 0-15 Volt meter indicates output. Output variable in eight steps. Excellent for demonstrating auto radios. Ideal for servicing — can be lowered to find sticky vibrators or stepped up to equivalent of generator overload — easily constructed in less than two hours. Complete in every respect.



**\$22<sup>50</sup>**

SHIPPING WT. 1.8 LBS.  
*Nothing ELSE TO BUY*

## 1949 MODEL Heathkit VACUUM TUBE VOLTMETER KIT

### Features

- New 200 ua Meter. 24 Ranges.
- New Accessory H.V. Probe makes Heathkit a kilovoltmeter. (Extra)
- New Accessory RF Probe extends range to 100 megacycles. (Extra)



**\$24<sup>50</sup>**

A new Model V-2 Heathkit VTVM with new 200 microampere meter, four additional ranges — full scale linear ranges on both AC and DC of 0-3 V., 10 V., 30 V., 100 V., 300 V. and 1,000 V. Accessory probe listed elsewhere in ad extends voltage range to 3,000 and 10,000 volts D.C. New model has greater sensitivity, stability and accuracy — still the highest quality features — shatter-proof plastic full view meter face — automatic meter protection, push pull electronic voltmeter circuit, linear scales — db. scale — ohmmeter measures 1/10 ohm to 1 billion ohms with internal battery — isolated DC test prod for dynamic measurements — 11 megohm input resistance on DC — AC uses electronic rectification with 6H6 tube. All these features and still the amazing price of only \$24.50.

Comes complete with cabinet — panel — three tubes — new Mallory switches — test prods and leads, 1% ceramic divider resistors and all other parts. Complete instruction manual for assembly and use. Better start your laboratory with this precision instrument. Ship. Wt., 8 lbs.

## Heathkit RF SIGNAL GENERATOR KIT

**\$19<sup>50</sup>**

*Nothing ELSE TO BUY*

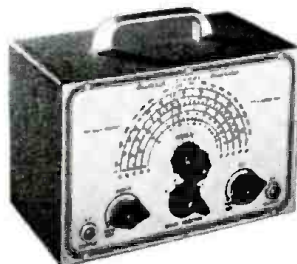

Every shop needs a good signal generator. The Heathkit fulfills every servicing need, fundamentals from 150 Kc. to 30 megacycles with strong harmonics over 100 megacycles covering the new television and FM bands. 110 V. 60 cycle transformer operated power supply. 100 cycle audio available for modulation or audio testing. Uses 6SN7 as RF oscillator and audio amplifier. Complete kit has every part necessary and detailed blueprints and instructions enable the builder to assemble it in a few hours. Large easy to read calibration. Convenient size 9" x 6" x 4 3/4". Shipping Wt., 4 1/2 lbs.

## Heathkit 5" OSCILLOSCOPE KIT

### Features

- Instant switching to plates or amplifier from front panel.
  - Sweep generator supplying variable sweep 15 cycles to 30,000 cycles.
  - All controls on front panel.
  - Cased electrostatically shielded 110 V. 60 cycle power transformer.
  - AC test voltage on front panel.
  - External synchronization post on front panel.
  - Deflection sensitivity .65 V. per inch full gain.
  - Frequency response ± 20% from 50 cycles to 50 Kc.
  - Input impedance 1 Megohm and 50 MMF.
- The Heathkit 5" Oscilloscope fulfills every servicing need. The husky cased power transformer supplies 1100 Volts negative and 550 Volts positive. Tubes supplied are two 6SJ7 amplifiers, 88-4 sweep generator, two 5Y3 rectifiers, and 5BP1 CR tube. Grey crackle aluminum cabinet and beautiful grey and maroon panel. Chassis especially designed for easy assembly.

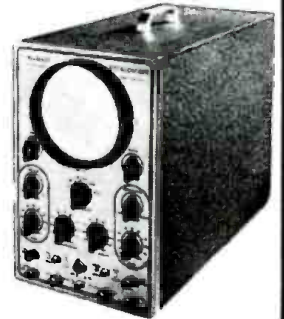

**\$39<sup>50</sup>**

*Nothing ELSE TO BUY*

An oscilloscope provides endless sources of experimentation in radio, electronics, medicine and scientific research. Detailed instructions make assembly fun and instructive. Shipping Wt., 24 lbs. Express only.

## New Heathkit SIGNAL TRACER AND UNIVERSAL TEST SPEAKER KIT

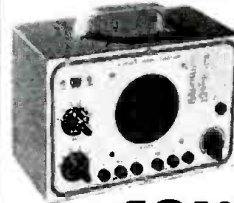

**\$19<sup>50</sup>**

*Nothing ELSE TO BUY*

The popular Heathkit signal tracer has now been combined with a universal test speaker at no increase in price. The same high quality tracer follows signal from antenna to speaker — locates intermittents — defective parts quicker — saves valuable service time — gives greater income per service hour. Works equally well on broadcast — FM or TV receivers. The test speaker has assortment of switching ranges to match push pull or single output impedance. Also tests microphones, pickups — PA systems — comes complete — cabinet — 110 V. 60 cycle power transformer — tubes, test probe, all parts and detailed instructions for assembly and use. Shipping Wt., 8 lbs.

## Heathkit ELECTRONIC SWITCH KIT

DOUBLES THE UTILITY OF ANY SCOPE

An electronic switch used with any oscilloscope provides two separately controllable traces on the screen. Each trace is controlled independently and the position of the traces may be varied. The input and output traces of an amplifier may be observed one beside the other or one directly over the other illustrating perfectly any change occurring in the amplifier. Distortion — phase shift and other defects show up instantly, 110 Volt 60 cycle transformer operated. Uses 5 tubes (1 6X5, 2 6SN7's, 2 6SJ7's). Has individual gain controls, positioning control, and coarse and fine sweeping rate controls. The cabinet and panel match all other Heathkits. Every part supplied including detailed instructions for assembly and use. Shipping Wt., 11 lbs.



**\$34<sup>50</sup>**

## Heathkit 3-TUBE ALL WAVE RADIO KIT

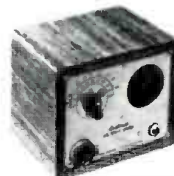

**\$8<sup>75</sup>**

An ideal way to learn radio. This kit is complete ready to assemble, with tubes and all other parts. Operates from 110 V. AC. Simple, clear detailed instructions make this a good radio training course. Covers regular broadcasts and short wave bands. Plug-in coils. Regenerative circuit. Operates loud speaker. Shipping Wt., 3 lbs.

HS30 Headphones per set.....	\$1.00
2 1/2" Permanent Magnet Loudspeaker.....	1.95
Mahogany Cabinet.....	2.95



The **HEATH COMPANY**

... BENTON HARBOR 20, MICHIGAN



**Y**our telephone receiver should treat each tone in the voice alike; that is important to you, because proper balance makes pleasant listening and easy understanding. Naturalness in receiver performance is pictured in a matter of seconds by the apparatus shown at left.

The receiver is clamped in place and an oscillator feeds into it frequencies representing all talking tones. Then a bright spot darts across an oscilloscope screen leav-

**It listens so  
YOU  
can hear better**

ing behind it a luminous line which shows instantly the receiver's response at each frequency. It is precise; and it is many times faster than the old method of measuring receiver performance point-by-point and then plotting a curve.

At Bell Laboratories, development of techniques to save *time* parallels the search for better *methods*. For each time an operation is made faster, men are freed to turn to other phases of the Laboratories' continuing job—making your telephone system better and easier for you to use each year.



**BELL TELEPHONE LABORATORIES**

EXPLORING AND INVENTING, DEVISING AND PERFECTING, FOR CONTINUED IMPROVEMENTS AND ECONOMIES IN TELEPHONE SERVICE.

RADIO-ELECTRONICS for

# SENSATIONAL! GIGANTIC!

An opportunity of a lifetime first come, first served. Act NOW!



ALL MDSE. SUBJECT TO PREVIOUS SALE

List Price	Description	Unit Price	Second Item	2 Units For:	List Price	Description	Unit Price	Second Item	2 Units For:	List Price	Description	Unit Price	Second Item	2 Units For:
19.95	Hi-Lo Folded Di-Pole T.V. All-Wave Aerials with Reflectors	12.00	.01	12.01	.50	Bull's Eye Indicator Lites for Standard Pilots	.30	.01	.31	5.55	MLP-1 Phono Cartridges with Permanent Needle	3.33	.01	3.34
19.95	Contact Microphone for Guitars, Etc.	12.00	.01	12.01	3.60	Aerial Kits: Wire, Ground Wire, Insulators, Etc.	1.80	.01	1.81	.50	Neon Test Lites	.30	.01	.31
1.65	75 Mil. Selenium Rectifiers (Standard Brand)	.99	.01	1.00	10.00	Resistor Kits (100 Assorted)	2.00	.01	2.01	1.50	A.C. Cords with Plugs, 6 Feet Long	.20	.01	.21
1.00	Spintiles, Assorted Sizes—1/4"=5, 1/2"=16, 3/4"=11, 1"=16	.60	.01	.61	2.00	T.V. Filters (For 10" Sets)	1.20	.01	1.21	1.50	Aerovox PBS 8 16 Mid. 250 Volt Capacitor	.90	.01	.91
.30	Rubber Tape (1/2 Lb. Rolls)	.30	.01	.31	5.95	Generator Condensers	.30	.01	.31	1.50	Philio 20 Mid. 450 Volt Capacitors (Tubular)	.90	.01	.91
.65	Spacchetti (Assorted Bundles)	.45	.01	.46	1.25	6" P.M. Speakers Standard Brand	3.60	.01	3.61	3.40	Solar 40 Mid. 450 Volt Capacitor (Cans)	2.04	.01	2.05
.10	Liquid Soluer (Tubes)	.06	.01	.07	12.50	Philio—Rear Seat Auto Speakers	7.50	.01	7.51	3.45	Solar 20 20 Mid. 450 Volt Capacitors (Cans)	2.07	.01	2.08
10.00	Ultra Mikes Wireless Oscillators with Tube and Mike	6.00	.01	6.01	2.95	Universal—4 Watt Output Transformer	1.80	.01	1.81	2.20	Aerovox PBS. 16 Mid. 450 Volt Capacitors	1.32	.01	1.33
25.00	Bantam Tool Kits: Grinder and 22 Attachments	15.00	.01	15.01	.05	2 Amp Fuses (3AG)	.03	.01	.04	1.30	Solar 20 20 Mid. 150 Volt Capacitors	.78	.01	.79
.75	Anten-a-Loop	.45	.01	.46	4.95	Shielded Lead Auto Aerials (with Switches 1/4-1/2-1 meg)	.75	.01	.76	1.45	Aerovox PBS. 8 Mid. 450 Volt Capacitors	.87	.01	.88
4.00	Aerovox—20-20 Mid. 450 Volt Capacitors (Cans)	2.40	.01	2.41	5.00	Portable Radio Cabinets	3.00	.01	3.01	.85	Philio 10 Mid. 150 Volt Capacitors (Tubular)	.51	.01	.52
2.65	Philio—20-20 Mid. 450 Volt Capacitors (Tubular)	1.59	.01	1.60	37.50	Television Boosters (Channels 1-6)	22.50	.01	22.51	1.70	Cornell Dubilier 30 50 Mid. 150 Volt Capacitors (Tubular)	1.02	.01	1.03
4.95	12" television filter, indiv. Packed	2.95	.01	2.96	80.00	Television Inverters (E.L.) with Built-in Relay	48.00	.01	48.01	3.95	Phono Pickups with Cartridge and Permanent Needle	3.60	.01	3.61
4.98	Telegraph Sets Pairs (In Attractive Gift Pkg.)	3.00	.01	3.01	1.00	Mailbox—1 Meg. Volume Controls	.60	.01	.61	16.95	Known Brand Crystal Microphones with Stand	10.20	.01	10.21
.80	8 Mid. 150 volt Capacitors Tubular	.48	.01	.49	3.50	Philio-Phono Needles: Long Play	2.10	.01	2.11	.25	Philio .001 to .05 Mid. 600V Capacitors	.15	.01	.16
3.98	5" Speaker Wall Baffles (Mottled Brown Wood)	2.40	.01	2.41	1.78	Radio Knobs—1/4" Shaft	.09	.01	.10	75	Philio .5 Mfd. 600 Volt Capacitors	.45	.01	.46
125.00	Hearing aids (3 Tubes) (Crystal Pickup and Ear-piece)	29.95	.01	29.96	.50	I.F. Transformers: 456; 262; or 175 Ke.	1.08	.01	1.09	75	Philio .25 M'd. 25 Volt Capacitors (Tubular)	.45	.01	.46
.95	Philio 20 Mid. 150 Volt Capacitors	.57	.01	.58	.13	Spark Plug Suppressors: Universal	.30	.01	.31	1.75	Philio 2 Mid. 300 Volt (F.P. fan)	1.65	.01	1.66
4.95	Chimney Mounts for T.V. & F.M. Aerials Complete with Hardware	2.99	.01	3.00	.65	Porcelain T.V. Insulators for 72 ohm d 300 ohm Leads	.09	.01	.10	.70	Philio .02 Mid. 1700 Volt Capacitors	.42	.01	.43
1.30	Philio—20-20 Mid. 150 Volt Capacitors (Tubular)	.78	.01	.79	1.25	R.F. Coils, for T.R.F. Sets.	.39	.01	.40		Philio Model 7001 Vacuum Tube Volt Meter-Ohmmeter and Capacitor Checker: All Ranges	104.50	.01	104.51
4.20	4 Prong-Standard Vibrators	2.16	.01	2.17	4.95	Single Output Transformers 50L6 G.T.	.75	.01	.76		Regal 3 Wav Radios—Battery and Electric	29.95	.01	29.96
4.95	5" P.M. Speakers	2.99	.01	3.00	2.00	12 Watt Universal Output Transformers	3.00	.01	3.01		Electric Condenser—20-10-5 Mid. 450 Volt and 50 Mfd at 25 Volt	.79	.01	.80
69.95	Coin Operated Radios (6 Tubes) (25c Slot) Plays 1 Hour for 25c	42.00	.01	42.01	.90	Line to Voice Coil Transformers	1.20	.01	1.21		Philio Indoor T.V. Aerials.	4.99	.01	5.00
3.95	Crystal Sets with Earphones in Attractive Pkg.	2.40	.01	2.41	.75	A.C.-D.C. Radio Chokes	.54	.01	.55					
.15	Alligator Clips	.05	.01	.06	.18	Aerial Wire (100 Ft. Rolls) Stranded	.45	.01	.46					
					5.95	Phenolic Octal Sockets	.10	.01	.11					
						8" 500 Ohm. Speakers (Utah)	3.60	.01	3.61					

## BEAUTIFUL STANDARD BRAND TELEVISION SETS FOR LESS THAN THE PRICE OF KITS!

Complete with Hand Rubbed Cabinets and Picture Tube

**7" MODEL 500 TABLE SET**

- 7" Electromagnetic Kinescope Tube, Picture Area 26 square inches.
- Only 4 Controls on Front of Cabinet: Off-On, Volume, Brightness, Channel Selector Switch and Contrast.
- Focusing and All Horizontal and Vertical Controls used for adjustment at time of installation are readily Accessible at rear of Cabinet.
- Power Transformer Provides Extra Safety Features.
- All Dangerous Shock Points Guarded by an Interlock Switch.
- 12-Channel Operation covering all of the Television Channels. Permits its use on any Station in any City.
- Beautiful Hand Rubbed Beautifully Grained Mahogany Cabinet.

SIZE: 11 1/2" x 17 1/2" x 17 1/2"  
SHIPPING WEIGHT: 45 pounds  
**YOUR PRICE: \$138.76**

**7" MODEL 501 PORTABLE**

- 7" Electromagnetic Kinescope Tube, Picture Area 26 square inches.
- Only 4 Controls on Front of Cabinet: Off-On, Volume, Brightness, Channel Selector Switch and Contrast.
- Focusing and All Horizontal and Vertical Controls used for adjustment at time of installation are readily Accessible at rear of Cabinet.
- Power Transformer provides Extra Safety Features.
- All Dangerous Shock Points Guarded by an Interlock Switch.
- 12-Channel Operation covering all of the Television Channels. Permits its use on any Station in any City.
- Large Style Leather Grain Case.

SIZE: 11 1/2" x 17 1/2" x 17 1/2"  
SHIPPING WEIGHT: 36 pounds  
**YOUR PRICE \$136.76**

**12" MODEL 700 TABLE SET**

- 12" Electromagnetic Kinescope Tube, Picture Area 82 square inches.
- Only 4 Controls on Front of Cabinet: Off-On, Volume, Brightness, Channel Selector Switch and Contrast.
- Focusing and All Horizontal and Vertical Controls used for adjustment at time of installation are readily Accessible at rear of Cabinet.
- Power Transformer Provides Extra Safety Features.
- All Dangerous Shock Points Guarded by an Interlock Switch.
- 12-Channel Operation covering all of the Television Channels. Permits its use on any Station in any City.
- Beautiful Hand Rubbed Period Style Dark Mahogany Cabinet.

SIZE: 18" x 22" x 18"  
SHIPPING WEIGHT: 105 pounds  
**YOUR PRICE: \$223.96**

TELEVISION SET GUARANTEE IS STANDARD R.M.A.

PARTS EXCHANGED FOR 90 DAYS AT NO CHARGE

**10" MODEL 600 TABLE SET**

- 10" Electromagnetic Kinescope Tube, Picture Area 62 square inches.
- Only 4 Controls on Front of Cabinet: Off-On, Volume, Brightness, Channel Selector Switch and Contrast.
- Focusing and All Horizontal and Vertical Controls used for adjustment at time of installation are readily Accessible at rear of Cabinet.
- Power Transformer Provides Extra Safety Features.
- All Dangerous Shock Points Guarded by an Interlock Switch.
- 12-Channel Operation covering all of the Television Channels. Permits its use on any Station in any City.
- Beautiful Hand Rubbed Period Style Dark Mahogany Cabinet.

SIZE: 19" x 22" x 19"  
SHIPPING WEIGHT: 105 pounds  
**YOUR PRICE: \$179.37**

**10" MODEL 601 FLOOR SET**

- 10" Electromagnetic Kinescope Tube, Picture Area 62 square inches.
- Only 4 Controls on Front of Cabinet: Off-On, Volume, Brightness, Channel Selector Switch and Contrast.
- Focusing and All Horizontal and Vertical Controls used for adjustment at time of installation are readily Accessible at rear of Cabinet.
- Power Transformer Provides Extra Safety Features.
- All Dangerous Shock Points Guarded by an Interlock Switch.
- 12-Channel Operation covering all of the Television Channels. Permits its use on any Station in any City.
- Beautiful Hand Rubbed Mahogany Console.

SIZE: 18" x 21" x 35"  
SHIPPING WEIGHT: 135 pounds  
**YOUR PRICE: \$222.17**

**12" MODEL 701 FLOOR SET**

- 12" Electromagnetic Kinescope Tube, Picture Area 82 square inches.
- Only 4 Controls on Front of Cabinet: Off-On, Volume, Brightness, Channel Selector Switch and Contrast.
- Focusing and All Horizontal and Vertical Controls used for adjustment at time of installation are readily Accessible at rear of Cabinet.
- Power Transformer Provides Extra Safety Features.
- All Dangerous Shock Points Guarded by an Interlock Switch.
- 12-Channel Operation covering all of the Television Channels. Permits its use on any Station in any City.
- Beautiful Hand Rubbed Mahogany Console.

SIZE: 18" x 21" x 35"  
SHIPPING WEIGHT: 135 pounds  
**YOUR PRICE: \$244.96**

TERMS: 25% deposit with order. Balance C.O.D. 2% off, if full payment is included with order. All items shipped F.O.B. Boston.

# LOUIS M. HERMAN CO.

885 BOYLSTON ST. BOSTON 16, MASS.

Established 1928; Rated with Dun & Bradstreet; Member Boston Better Business Bureau

D I S T R I B U T O R S O F F A M O U S M A K E S N A T I O N A L P R O D U C T S



## OHMITE

### Little Devil

INSULATED  
COMPOSITION RESISTORS

In critical television applications, Little Devil Resistors can be depended on for longer, trouble-free service. These tiny, rugged units give quiet performance and are ideal for sensitive RF circuits. Moreover, they are available in  $\pm 5\%$  as well as  $\pm 10\%$  tolerances—in  $\frac{1}{2}$ , 1, and 2-watt sizes; standard RMA values.



### NOISE-FREE TYPE AB POTENTIOMETER

Continued use has little effect on the resistance of this unit because the resistance material is solid-molded—not sprayed or painted on. In fact, the noise level often becomes less with use. The unit has a 2-watt rating with a good safety factor.

SEND NOW for Catalog No. 21

OHMITE MFG. CO.  
4894 Flournoy St., Chicago 44



Be Right with...

## OHMITE

RHEOSTATS • RESISTORS • TAP SWITCHES

American Phenolic Corporation of Chicago reports a net profit for the year ended December 31, 1948, of \$183,141, equal to 46 cents a share. This compares with a net of \$66,491 or 17 cents a share for the preceding year.

Transvision, Inc. of New Rochelle, N. Y., has been appointed exclusive national distributor of Du Mont Inputuners through jobbing, amateur supply, and retail channels, it was announced by HERBERT SUESHOLTZ, general manager of Transvision. The company has been granted the exclusive right to use the Inputuner in its television kits.

Resistors, Inc. of Chicago has moved into its own new plant, according to an announcement by JOSEPH J. CERNY, founder and president. The new building is located at 5226 West 26th Street, Chicago.

RCA Communications, Inc., New York, has opened the first direct radiotelegraph circuit between the United States and Pakistan, according to HARRY C. INGLES, president of the company, George V. Allen, U.S. Assistant Secretary of State, and Hon. Sardar Abdur Rab Nishtar, Pakistan Minister of Communications, inaugurated the service with an exchange of messages.

Since the formation of Pakistan, the United States has been supplying it with large quantities of heavy machinery, automobiles, and farm equipment. In return, this country has received substantial quantities of jute, cotton, tea, hides, wool, and chrome ore. Because of this increasing trade exchange, Mr. Ingles said, it is believed that the new circuit will handle more than 2,000,000 words in its first year of operation.

International Telephone & Telegraph Corp., New York, announces a net income for 1948 of \$2,197,877, against \$1,371,697 in the preceding year of 1947.

Sylvania Electric Products, Inc., Salem, Mass., reports that the consolidated net income for the first quarter of 1949 was \$1,176,815, compared to \$1,162,737 earned during the first quarter a year ago. Net income for the first quarter of 1948 included approximately \$180,000 of nonrecurring income arising from a profit on the sale of its assembly plants in Bloomington, Ill., and Riverside, Calif., as well as certain tax credits that the company did not have this year. On the basis of the average number of shares outstanding during the quarter (1,228,772) the net income was equal to 88 cents per common share, after deducting dividends of \$1.00 a share on the \$4 cumulative preferred stock. This compares with \$1.06 a share earned on the 1,006,550 common shares outstanding during the first quarter of 1948.

Consolidated net sales for the quarter ended March 31, 1949, were \$27,108,895, an increase of 10.4% over the \$24,547,529 of sales for the first quarter a year ago.

Radio Corp. of America, New York, through its chairman of the board, BRIGADIER GENERAL DAVID SARNOFF, announced at the 30th Annual Meeting of RCA stockholders that net profit, after taxes, of RCA for the first quarter of 1949 was \$5,932,083, an increase of \$167,585 over the same period in 1948. Profit for the first quarter of 1949—before federal income taxes—amounted to \$9,804,083, compared with \$9,631,498 in 1948.

Earnings per common share for the first quarter of this year amounted to 37.1 cents, as compared with 35.8 cents per common share for the first quarter in 1948. Consolidated gross income of RCA during the first quarter of 1949 amounted to \$92,327,827, compared with \$88,053,297 for the same period last year. This represents an increase of \$4,274,530 over the 1948 figure.

Army-Navy Electronic Standards Agency has been reconstituted as the Armed Services Electro Standards Agency. The change provides for official participation by the Air Force.

Employing 126 persons, the Agency occupies five buildings just outside the main area of Fort Monmouth, N.J., near the Signal Corps Engineering Laboratories. Sales and technical representatives of radio-electronics manufacturers are welcome to visit the Agency at any time, according to its officials, to obtain firsthand information on the work it is doing.

The mission of the Agency is:

1. To reduce the number of styles and types of electronic components used in the manufacture of military equipment of all kinds;
2. To insure their quality and dependability;
3. To achieve a high degree of interchangeability;
4. To designate approved sources of supply.

The Radio Manufacturers Association is cooperating wholeheartedly in implementing this program. A procedure for obtaining industry agreement on proposed JAN (Joint Army-Air-Navy) specifications was worked out by RMA and the Agency at a meeting held in New York at the time of the IRE convention this year.

Considerable progress in alleviating the war-born confusion over electronic parts is being made. For instance, three standard crystal holders, to meet any foreseeable requirement, have been adopted to replace 350 different holders which were formerly used. A single, standard, wire-wound resistor takes the place of 33 former nonstandard types. Audio and power transformers that required more than 10,000 different sizes and shapes of cases can now be accommodated in only 22 standard containers. Measuring instruments and tubes have received special attention. More than 37,500 types of meters have been reduced to 3,700 standard types, and 3,000 types of vacuum tubes have been cut down to 800 for replacement purposes and to about 200 for new applications.

RADIO-ELECTRONICS for



# Famous Sylvania Polymer now available with new plus features for complete television service!

- Shielded ac probe lead—reduces stray field effect.
- Microphone type panel connectors on probe leads insure firm, long life connections.
- RF probe features ground clip and detachable extension tip—extremely flexible in application.

## CHECK THESE OTHER OUTSTANDING FEATURES:

The essentially flat frequency response of 20 cycles to 300 mc. and useful range to 500 mc. gives this complete vacuum tube voltmeter a range low enough to test high fidelity amplifiers, yet high enough to accommodate all television frequencies.

The instrument has seven current scales—six of them reading in milliamperes and one reading in amperes. The specially engineered Sylvania Subminiature Tube contained in the RF Probe permits the exceptionally high frequency range of this instrument at a high input impedance and an unusually low input capacitance.

The large 4½" meter affords maximum readability, while careful design minimizes error introduced by line voltage variation, tube variations and stray fields.

Be sure to send your coupon today to receive full particulars on the new Sylvania Polymer Type 221!



### RANGES

DC volts	0-3, 10, 30, 100, 300, 1000, 10,000*
AC volts	0-3, 10, 30, 100, 300, 1000
RF volts	0-3, 10, 30, 100, 300
Resistance Ohms	0-1000, 10,000, 100,000, 1 meg., 10 meg., 1000 meg.
Current Ma	0.3, 10, 30, 100, 300, 1000
Current Amps	0-10

DC, AC, RF and Ohm scales utilize authentic Vacuum Tube Voltmeter Circuits resulting in extremely low load when measuring delicate circuits.

### FREQUENCY

AC volts	20 cps to 15,000 cps
RF volts	10,000 cps to 300 mc



\*With this new DC Voltage Multiplier, Type 223, the 1,000 vdc range setting on the new Sylvania Polymer will read 10,000 vdc full scale! The 300 vdc range setting will read 3,000 vdc full scale! Add this accessory and you have a Kilovoltmeter for testing TV circuits and other high dc voltage applications. Only \$9.95!

# SYLVANIA ELECTRIC

ELECTRONIC DEVICES; RADIO TUBES; CATHODE RAY TUBES; FLUORESCENT LAMPS,  
FIXTURES, WIRING DEVICES, SIGN TUBING; LIGHT BULBS; PHOTOLAMPS

Sylvania Electric Products Inc.  
Advertising Dept. R-1707  
Emporium, Pa.

Gentlemen: Send full details on new Polymer Type 221 and  
accessory probe Type 223.

Name .....

Address .....

City .....

State ..... Zone .....

# Want To Double Your Pay?



## How To Pass **FCC** **COMMERCIAL** **RADIO OPERATOR** **LICENSE** **EXAMINATIONS**

**GET THIS AMAZING NEW BOOKLET FREE!**

Add Technical Training to Your Practical Experience and

### GET YOUR **FCC** **COMMERCIAL** **RADIO OPERATOR** **LICENSE**

**IN A FEW SHORT WEEKS!**

It's EASY if you use CIRE Simplified Training & COACHING AT HOME in SPARE TIME

Get your license easily and quickly and be ready for the jobs open to ticket holders which lead to \$3000 to \$7500 (average pay reported by FCC nationwide survey). CIRE training is the only planned course of coaching and training that leads directly to an FCC license.

**CIRE GRADUATES FIND  
FCC LICENSE PAYS OFF**

"I now hold ticket Number P-10-3787, and holding the license has helped me to obtain the type of job I've always dreamed of having. Yes, thanks to CIRE, I am now working for CAA as Radio Maintenance Technician, at a far better salary than I've ever had before. I am deeply grateful."  
Student No. 3319N12

"I took the FCC examination on March 4th and received my second class radiotelephone license March 9th. I go to work for the Trans-Texas Airways in the maintenance department. Thanks for all the assistance."  
Student No. 2394A1

**CLEVELAND INSTITUTE OF RADIO ELECTRONICS**  
Desk RC-7 4900 Euclid Building, Cleveland 3, Ohio  
Approved for Veteran Training under the "G. I. Bill of Rights"

1. Tells of thousands of brand-new, better-paying radio jobs now open to FCC License-Holders.
2. Tells how you will benefit by holding an FCC Commercial License.
3. Tells how YOU can get your FCC Commercial Radio Operator License IN A FEW SHORT WEEKS—EASILY AND QUICKLY, by using CIRE simplified training and coaching AT HOME in your SPARE TIME.
4. Tells of hundreds of our successful students who now have licenses and new, better-paying jobs.
5. Tells how we prepare you to pass the new FCC Commercial License Examinations, which now include FM and Television.
6. Tells how we guarantee to train and coach you until you get your license.
7. Tells how we help you get a better-paying, licensed job, with our free and exclusive service, which prepares your employment application for mailing to hundreds of employers, including FM, AM and Television Broadcast Stations, Radio Manufacturers, Police Radio Stations, and Radio-Equipped Taxi, Bus, and Public Utility Companies.



**YOUR FCC TICKET IS ALWAYS RECOGNIZED IN ALL RADIO FIELDS AS PROOF OF YOUR TECHNICAL ABILITY**

**Get All 3 FREE** Send Coupon Now!

**CLEVELAND INSTITUTE OF RADIO ELECTRONICS**  
Desk RC-7, 4900 Euclid Bldg., Cleveland 3, Ohio  
(Address to Desk No. to avoid delay)

I want to know how I can get my FCC ticket in a few short weeks by training at home in spare time. Send me your amazing new FREE booklet "Money Making FCC License Information," as well as a FREE sample FCC-type exam and FREE booklet, "How to Pass FCC License Examinations" (does not cover exam for amateur license).

Name \_\_\_\_\_  
Address \_\_\_\_\_  
City \_\_\_\_\_ Zone \_\_\_\_\_ State \_\_\_\_\_  
 Veterans check for enrollment information under G.I. Bill  
**NO OBLIGATION—NO SALESMEN**

# Biological Electronics

. . . *Electronic Health Research is Forging Ahead Rapidly* . . .

By HUGO GERNSBACK

**A** MOST important branch of electronics concerns itself with *electronic biological research*. It has expanded rapidly during recent years and is certain to gain greater importance because it is now recognized as one of the dominant factors in improving the health of all living things.

It has been known for over 150 years that many biological processes are electric in nature. Thus for instance, muscular electricity is generated when a muscle is flexed. This effect can be accurately measured and recorded. That electricity is biologically produced is best illustrated by the electric eel which can generate several hundred volts of electric current—a sufficient electrical force to paralyze a man or a horse. Electric eels were used at the New York Aquarium and elsewhere to light a string of 117-volt neon lamps—no mean feat for a purely biological electrical force.

The human heart, which is in reality a large muscle, generates a fluctuating current which is readily detected by that modern electronic instrument, the electrocardiograph. It amplifies the heart currents by means of an electronic amplifier; it then traces an undulating graph of the heart currents on a moving paper tape with an ink or similar stylus.

As far back as 1911, the writer suspected that the animal brain generates electrical currents during the thinking processes. In his novel, *Ralph 124C 41+*, first published in 1911, he described a hypothetical instrument which he named the *Menograph*. By discs strapped to the side of the human head, impulses were conveyed to a machine which traced a graph on a moving strip of paper. This was supposed to give a permanent record of your thoughts which could then be read by one who had learned to interpret the graph. In other words, a sort of mind-writer or mind-writing machine.

This early prediction was partly realized in 1935 when Dr. Hollowell Davis of Harvard Medical School used an electroencephalograph in registering brain waves, recording them on a moving tape precisely as imagined by the writer 25 years before. The electroencephalograph is being used more and more in research medicine today, particularly in diseases of the mind such as epilepsy, chorea (St. Vitus dance), and in many other nervous disorders. It has become a most important tool of medical science.

Animal vision as we know it today is of a photochemical-electrical nature. We still do not know all that is to be known about it. As has been pointed out many times in these columns, the animal eye

perhaps holds the secret of future, improved television. Our present television transmitters use a system of mosaic "seeing" which comes close to animal vision, but does not duplicate it by any means. Our transmitters *still scan*, whereas the animal eye does no scanning. Future television, transmitting as well as receiving, will probably do away with all present-day scanning means. This should greatly simplify our future receivers.

A most interesting biological electrical effect is connected with ovulation. The human female ovulates at an uncertain time during her monthly biological cycle. Ovulation takes place approximately midway between the menses. The ovaries then release a female human egg. Since this egg is much smaller than the period at the end of this sentence, it is almost impossible to trace it physically. But electronics has come to the aid of the medical research laboratory and it is possible today, by purely electronic means, to know the exact time of ovulation by merely connecting one electrode over the abdomen of the subject, the other electrode going to the wrist. The electronic instrument records a varying curve of the electric potential, while the subject sleeps. It also records her varying temperature. It was found that the woman's electric potential increases to a peak during ovulation. Her temperature is also highest at that moment. The exact time of ovulation is important for women who have difficulty in conceiving, because the best time for conception is right after ovulation. Much work remains to be done in this field.

Similar research work now being carried out in embryology indicates that the growth and behavior, as well as pre-natal diseases and defects of the human fetus may be charted with equal accuracy.

Very recently electronics has been drafted into cancer research, particularly research on internal cancers. While nothing of any definite nature has as yet been announced in this branch, medical researchers believe that electronics will play an increasingly important role in internal cancer research due to the difference of electrical potentials in cancer cells as compared to normal cells. It is even highly conceivable that electronics will help us to throw new light on cell growth in general.

This short article must of necessity be sketchy. It would take a number of pages to merely enumerate all the various facts and usages of the new art. Biological electronics has only made a beginning. It is safe to predict that an entirely new and most important science will be founded on it, which will greatly benefit not only humans but all animal and plant life as well.

# Reasons and Remedies For TV Interference

by David Gnessin

**U**NSATISFACTORY reception of television signals is caused primarily by either

1. Attempted reception of signals beyond the normal service range of a station, or

2. Deficiencies in receiver design.

The average full-power television station has a normal reception radius of only approximately 40 miles. Receivers require a relatively strong signal to overcome interference from other radio or television stations or from nonradio devices, such as heating pads, flashers, etc. The desired signal must be at least 100 times as strong as an undesired interfering signal for satisfactory reception, whereas standard broadcast reception requires a signal-to-noise ratio of only 20.

At present, many television stations are operating with low power, pending the delivery of higher-power equipment—and other stations in smaller cities have been permanently assigned lower power. Under these circumstances, the satisfactory reception range may be as low as 20 miles.

Normally, television manufacturers and reputable technicians will inform set buyers of the expected range of a television receiver for any specific location. Occasionally, however, an installation, made when freak conditions allowed excellent reception in a fringe area, leaves the set owner with short periods of good reception and long periods of idleness in between.

Certain receivers have sufficient sensitivity to receive desired stations but not enough selectivity to reject undesired stations. It is usually safe to disregard this and accept the consequent saving in manufacturing cost, as most receivers are sold in areas where there

is little chance of adjacent-channel interference. However, in many cases, receivers are used in areas of low signal strength or near a radio station operating on another frequency. Then, if the receiver does not have sufficient selectivity, reception is unsatisfactory. The possible alternatives are to obtain a receiver with good electrical characteristics or to install wavetraps or other rejection devices.

## Types of interference

Television interference is audible in the sound channel, appears in the picture as bars or herringbones, or else causes reversed or torn images. Most

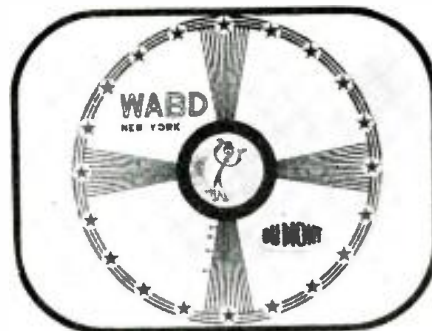

Fig. 1—Normal test pattern looks like this.

likely to occur where the television station signal is weak and the undesired signals are strong, such interference can be divided into six categories:

**FM broadcast signals** are received because of the set's poor image rejection when the FM station is operating on a frequency removed from the wanted frequency by twice the set's i.f. The trouble may occur when the receiver is tuned to channels 2, 3, or 4. This interference is a receiver design

fault. Trap circuits or reorientation of the antenna may relieve it. Fig. 1 is a normal test pattern. Fig. 2 shows the effect of FM interference.

**International shortwave broadcast and point-to-point telegraph stations** may be received on all television channels. This is due to direct feedthrough from the r.f. section of the receiver to the i.f. amplifier. The trouble is common in prewar receivers having an i.f. of 8 to 12 mc, and occasionally occurs in postwar receivers with i.f.'s between 21 and 26 mc. Again, trap circuits at the antenna terminals are usually effective. Fig. 3 shows the effect on the screen of this type of interference.

**Amateur radio stations** may be heard or seen on a television receiver. Harmonics of stations operating on 10 meters may come through or there may be adjacent-channel response to stations operating in the 6-meter (50-54-me) amateur band. That you hear an amateur station on your television receiver is not necessarily an indication that the amateur is operating off frequency or in any other illegal manner. It may mean that the amateur station's

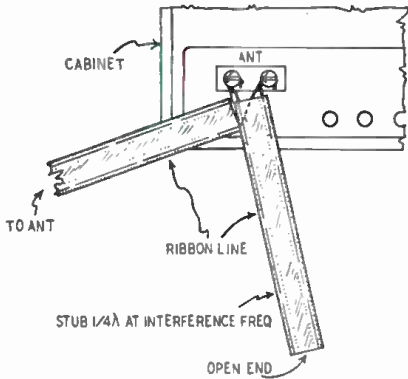

Fig. 2—Bars caused by interfering ham or FM.

RADIO-ELECTRONICS for

signal is many times stronger than the desired television signal and your receiver is not designed for adequate rejection under these conditions.

By adding preselection or appropriate filters to the receiver, interference may be eliminated or greatly reduced. The amateur's assistance should be solicited



Open quarter-wave stub acts as a tuned trap.

and adjustments made on a co-operative basis. This is especially true in the case of harmonics, which cannot be eliminated by traps on the receiver without removing the desired picture. Figs. 2 and 3 show this type of interference.

**Police, aviation, utility, and other low-power signals** have the same appearance on the screen and may be cured in the same ways.

**Automobile ignitions** send out r.f. pulses at a high rate. In slight and moderate cases, the pattern on the screen is unaffected except that short, white lines appear across the picture, as in Fig. 4. Strong ignition interference may tear the picture badly.

**Medical diathermy machines, industrial heating appliances, flashers, heating pads, and many other electrical devices** are, in effect, radio transmitters. Though frequencies have been assigned for diathermy and industrial heating, it will probably be some time before all existing machines are replaced by ones designed to operate on the assigned frequencies; in the interim, it will be necessary to solve the interference on a case-to-case basis. These signals may be identified by a scratching or tearing sound or by a low-pitched hum on the sound channel of a receiver, and by moving bars or tears in the picture (Figs. 5 and 6). Once the offending machine is definitely located, it is usually possible to add signal-suppressing equipment to it.

**Interference from other television receivers** is probably the most difficult complaint to explain to the set owner. The effect is similar to that produced by diathermy or industrial heaters. Moving one or both antennas may help.

Each receiver contains an oscillator which may radiate a strong signal over a distance of a few hundred feet. This shows poor r.f. amplifier design, and should be classed as a deficiency in the offending receiver. It usually occurs when one set is tuned to one of the lower channels and the complaining re-

ceiver is tuned to one of the higher channels. For instance, a TV set tuned to channel 5 picks up the oscillator signal of a neighboring receiver tuned to channel 2.

Any filter circuit will cut down the desired signal as well as the interference; there is no stock remedy. Tactful contact with neighbors suggesting possible schedules, reorientation of antennas, shielding oscillators, improvement of preselectors are all possible answers.

**Curing interference**

The following steps are recommended for the technician in the event complaints are encountered:

1. Determine whether the trouble is occurring on all makes of television receivers in use in your area. If the trouble occurs predominantly on one make of receiver, it may be due to receiver design deficiencies.

2. Check all electrical devices in the complainant's home, such as heating pads, refrigerators, etc. Turn them on and off, observing results on the TV set.

The August issue of RADIO-ELECTRONICS will feature an important article entitled "Improve Your Television Picture." Especially slanted toward the non- or semi-technical set owner, it will give a number of valuable hints on easy and effective ways of stepping up the signal, reducing or eliminating ghosts, best placement of the receiver in the room, and the use of enlarging lenses, filters, and boosters. Adjustment of controls will come in for some attention; as most viewers know, this is by no means as simple as turning on a sound radio receiver. Reserve your August copy of RADIO-ELECTRONICS at your newsstand now.

3. Obtain assistance from the research or production engineering department of the manufacturer of the receiver you are selling or servicing. Most manufacturers have experts who have already had experience in the solution of these problems.

It is possible to add trap circuits to the input terminals of a receiver and reject an unwanted signal, provided the unwanted signal is on a frequency other than the desired signal. Suppose a television receiver tuned to channel 2 is receiving image interference from an FM station on 100 mc. A piece of transmission line cut to one-quarter the wavelength of the undesired station and attached across the input terminals of the receiver along with the antenna lead-in may considerably reduce the interference if it is not bad.

To determine the length in feet of such a stub, divide 246 by the station frequency in megacycles. For example:  $246/100 \text{ mc} = 2.46 \text{ ft.} = 29.25 \text{ inches}$  (approximately).

Cut the piece of transmission line a few inches longer than the formula indicates and attach it to the receiver terminals. Cut off a small piece at a time until it tunes to the desired frequency and the unwanted signal is reduced. Leave the end open.

The material in this article was abstracted from Federal Communications Commission bulletin 48-1804 (22929).

(Test patterns courtesy NBC, RCA, Allen B. Du Mont and Philco Corp.)



Fig. 3—Amateur interference may cause this.



Fig. 4—Moderate ignition-interference lines.



Fig. 5 (above) and Fig. 6 (below)—Diathermy and other devices may bring these bad results.



# How a TV Station Operates



Photos courtesy RCA

This is an image-orthicon camera with telephoto lens in the turret.

**T**HE technician who repairs television receivers finds himself working on circuits much like those at the transmitting station, and he must deal with signals sent by the transmitter. In television, the interlocking of the received signals with operation of various parts of the set is more vital than in almost any previous radio work. It is logical to expect that a knowledge of TV stations will aid the technicians.

The block diagram of Fig. 1 gives a skeleton picture of the makeup of a station. The heart of the video system is the camera, which translates light variations into voltage variations.

The synchronizing generator is the traffic policeman of television. It sends out a complex series of pulses that control the vertical and horizontal sweeps, the retrace blanking, and the flyback of the electron beams in both studio camera and home receiver viewing tube. It is the unit responsible for keeping camera and cathode-ray tubes exactly in step so that televiewers at home see a replica of the studio scene rather than a crazy-quilt pattern of unrelated light blobs.

The control, mixing, and switching equipment amplifies signals for several cameras, mixes or selects the scenes from each, and adds the synchronizing pulses in the correct amounts. Here, too, aberrations in the picture—light or dark patches which don't belong there, curved lines that should be straight—are corrected by control men whose fingers play constantly over a console studded with small knobs, injecting square, parabolic, or sine waves in amounts just large enough to cancel out the trouble. The output from this section of the station is called the *composite signal* because it contains everything necessary to produce a picture.

The transmitter is merely a link in the communication chain, carrying the composite signal to the receiver. Because the composite signal covers a wide range of video frequencies, the transmitter must be capable of taking modulation up to about 6 mc.

The studio sound equipment is like that in a standard broadcast station. Microphones, of course, are not set up on stands but are carried on long booms so they can be suspended above the scene and out of camera view. An operator in the control room mixes the sound from the microphones and from phonograph turntables. It then passes to an FM transmitter, similar to 88-108-mc transmitters except for its frequency and the fact that modulation swing is only 50 kc instead of 150 kc.

The mobile pickup equipment, carried in one or more trucks, is a complete television station in miniature. It includes cameras, sync generator, mixing equipment, and sound apparatus. The output of the mobile unit modulates a small u.h.f. transmitter, also carried in a truck. The sound may be transmitted in the same way, or—depending on conditions—it may be sent to the studio *via* wire line.

At the studio a receiver picks up the signal from the mobile transmitter and demodulates the r.f. to obtain a composite video signal. This is used to modulate the regular station video transmitter to send the remote picture along to home receivers. One of the photos shows the essential video equipment for a field pickup.

## How the "ike" works

The starting point of the television chain and the device which made video a practical medium is the camera tube. Before the war the iconoscope was the

A general knowledge of how the TV signals originate will help the repair technician with his daily television servicing job

By MORTON SHORE

most used. Though the image orthicon is much more popular today, the "ike" is still in service because of its high definition under very bright light.

Fig. 2 is a simplified schematic drawing of an iconoscope. A mosaic of silver-cesium compound (cesium is light-sensitive) is deposited on one surface of the mica plate. It is made up of millions of extremely fine globules, each insulated from the others. On the rear of the mica plate a solid metallic layer (platinum) is deposited. This is the signal plate. Effectively, there are millions of minute capacitors, one plate of each being a globule of cesium-silver, with the signal plate common to all the capacitors.

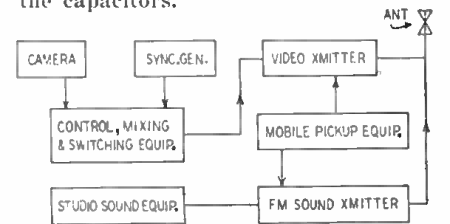

Fig. 1—Diagram traces signal through station.

When cesium is struck by light, it emits electrons. The number of electrons liberated is in direct proportion to the intensity of the light. When the scene to be televised is focused on the mosaic of tiny silver-cesium globules, each globule emits electrons in proportion to the light striking it. Since it lacks electrons, each globule is then somewhat positive with respect to the signal plate and acts as a charged capacitor.

As the scanning beam reaches each charged globule, it replaces the lost electrons and neutralizes the charge. The small pulse of electrons redistributing themselves on the two plates of the capacitor (globule and signal

RADIO-ELECTRONICS for

plate) flows through the resistor and creates a voltage drop across it which is amplified and sent to the mixing equipment. The pulse amplitude at any instant is, of course, proportional to the brightness of the light striking the globule being discharged.

**The image orthicon**

The iconoscope is not the most satisfactory camera tube because of its low signal output and because secondary electrons, emitted from the mosaic by the impact of the high-speed scanning beam, fall back on it and create random signals which affect the shading of the picture. In addition, the tube is large and difficult to use in cameras with rotatable lens turrets.

The image orthicon is smaller, much more sensitive, especially at low light levels, and gives excellent definition. Its construction is shown in Fig. 3.

Light from the scene to be transmitted is focused on the transparent photocathode, whose light-sensitive coat-

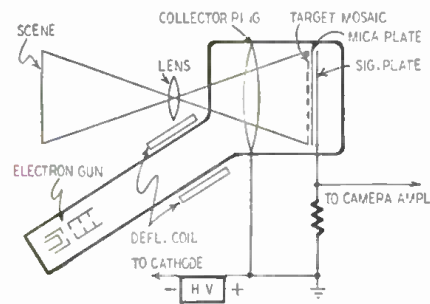

Fig. 2—Iconoscope is bulky, contains mosaic.

ing emits electrons in proportion to the light intensity. These electrons, magnetically focused by coils around the tube, are drawn in straight lines toward the target screen. The screen is at zero volts with respect to ground, while the photocathode is held at -300; the screen is, therefore, positive with respect to photocathode and attracts electrons from it at a fair rate of speed.

About half of the photo-electrons pass through the screen and strike the target, a piece of very thin, low-resistivity glass. The resistivity of the glass is so low that a charge on one of its surfaces is transmitted to the opposite surface very quickly, but it is so thin that a charge at any point on the glass does not have time to spread appreciably over the surface during the time of one frame.

The photoelectrons passing through the target screen hit the target hard enough to release secondary-emission electrons from it; several electrons are released for each electron which hits the target. The secondary electrons are collected by the target screen.

Since the electrons liberated from each point on the target are greater in number than those hitting it, the net charge on any area is positive in proportion to the light in the corresponding area of the original scene.

The scanning beam, originating in the electron gun, is a low-velocity

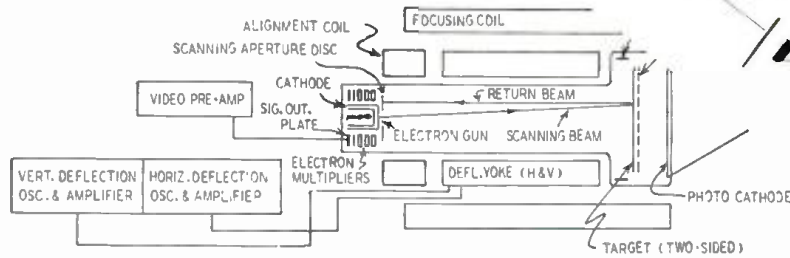

Fig. 3—Image orthicon has electron multiplier for high sensitivity, works with low light.



The small size and convenient shape of the image orthicon suit it for many applications.

stream (unlike that in the iconoscope); when it strikes the target, it has not enough force to dislodge secondary electrons of its own. The scanning beam is reflected by the target, and a return beam goes back toward the origination point.

If no light were present and no areas of the target were positive, the return beam would have constant amplitude. But whenever there is light and the scanning beam strikes a target area which is positive, it loses some of its electrons to the target—enough of them to neutralize the target's charge. At these instants, the return beam's amplitude decreases because of the electrons left behind on the target. The return beam is thus amplitude-modulated with picture information.

The return beam hits the scanning aperture disc hard enough to dislodge secondary electrons from it—again sev-

eral are emitted for each one striking. In effect, there is an amplification of the modulated return beam. The secondary emission from the disc goes into the electron multiplier surrounding the cathode structure. The multiplier is similar to those found in some high-gain multiplier phototubes; its output is fed to a vacuum-tube video amplifier.

The sensitivity of the image orthicon is comparable to that of the human eye; it is considerably greater than that of high-sensitivity motion-picture film. In fact, a single candle provides enough illumination to transmit a television picture. It does its best work at comparatively low light levels, where the output is directly proportional to the light. Where the light is very bright, changes in illumination do not produce a change in output, so an iconoscope is preferable—though the image orthicon can be used.

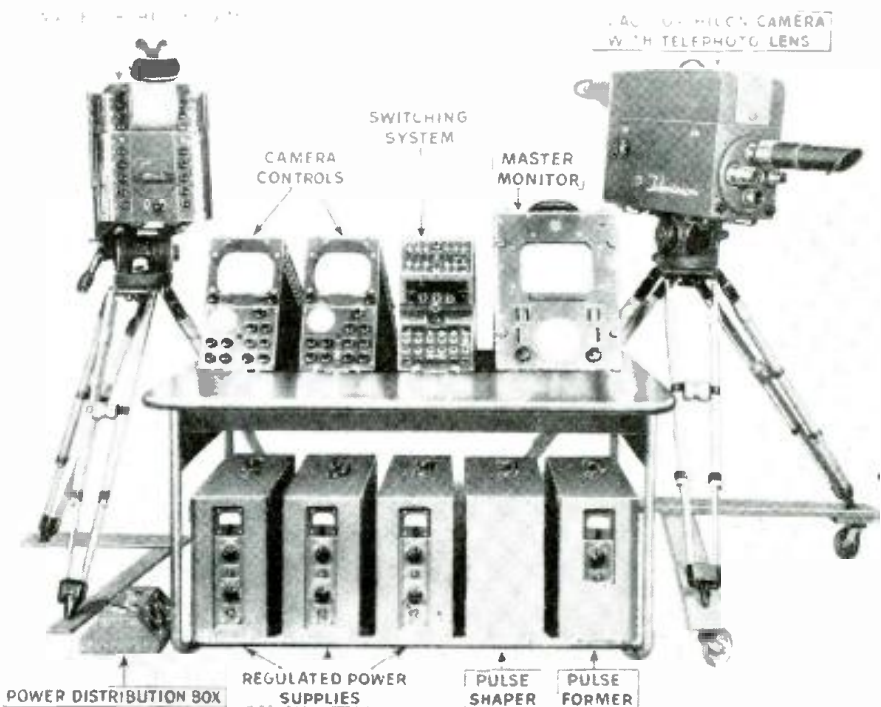

The essential equipment for a remote telecast shown here is portable—a miniature station.

# Circuits for Horizontal A.F.C.

*Operation of automatic frequency control circuits in horizontal sweep oscillators of TV receivers*

By LOUIS E. GARNER, Jr.

IT IS of the utmost importance in television to avoid picture distortion, that the frequency of the horizontal sweep circuit in the receiver be exactly equal to that of the sweep in the camera tube. In addition, the phase relationships between the two sweeps must be correct—the sweep for a particular line in the receiver must start at the same time as the sweep scanning that line at the transmitter.

For this reason, synchronizing pulses are sent as part of the transmitted television signal, and these pulses are used at the receiver to synchronize the sweep circuits. There are a number of ways of utilizing the sync pulses, the simplest being to use the pulses to trip a single-stroke sweep circuit.

Such a method, while theoretically ideal, falls down in practice for several reasons. First, where the pulse varies in strength, as may be the case when tuning from station to station, the sweep width may also vary. Second, if the pulse should fail to be present at a particular line, the sweep would not occur. And third, a noise pulse would have no difficulty in tripping the sweep at the wrong time.

Because of the difficulties encountered with single-stroke, pulse-controlled sweeps, self-oscillating sweep circuits are universally used in modern television sets. But this brings up the

problem of controlling both the frequency and phase of a local oscillator, while at the same time avoiding troubles introduced by noise pulses. A number of automatic-frequency control (a.f.c.) circuits have been devised and put into use, but most are of four basic types.

A very popular a.f.c. circuit, used by RCA, Admiral, Motorola, and others, is shown in simplified form in Fig. 1.

The 6K6 is connected as a conventional Hartley oscillator, its operating frequency depending upon the resonant frequency of a tuned circuit consisting of primary coil L2, distributed capacitance, and the 6AC7 reactance tube. (Capacitors C1 and C2 provide the necessary feedback from the plate circuit to the grid-cathode circuit of the 6AC7, so that the plate current of the tube lags the plate voltage by 90 degrees. The 6AC7 thus acts as an inductance shunting L2.

How much inductance the tube presents is determined by its plate current which, in turn, is dependent upon grid bias. If the bias is increased, the plate current is reduced, and the tube acts as an inductance of higher value. Thus, if the negative d.c. voltage on the grid of the 6AC7 is increased, the operating frequency of the 6K6 oscillator is reduced. When the bias voltage is reduced, the operating frequency is increased.

The output from the plate circuit of the 6K6 oscillator is fed to a differentiating circuit (not shown), and the pulse produced controls a tube used to discharge a capacitor in a conventional R-C sawtooth generator. The sawtooth is amplified and used for sweep purposes.

Coil L1 is coupled to L2, and the sine-wave voltage appearing across it is applied to the diode plates. The horizontal pulse from the sync amplifier is applied to the diodes through coupling capacitor C3. Thus, the a.c. voltage applied to diodes D1 and D2 consists of both a pulse and a sine wave, having a combined wave shape as shown in Fig. 2-a.

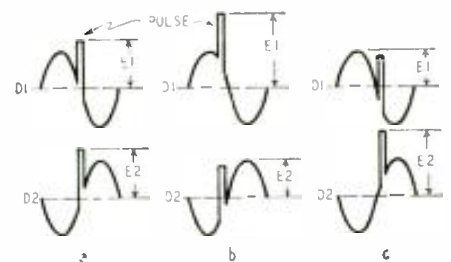

Fig. 2—Waveshapes applied to 6AL5, Fig. 1.

The voltages applied to D1 and D2 are equal. The sine-wave components are 180 degrees out of phase, but the pulse is in phase on the two plates.

A d.c. voltage appears across R3 when D1 conducts on positive peaks. A similar d.c. voltage appears across R4 when D2 conducts. The voltage across either resistor depends on the amplitude of the positive a.c. peaks.

When the applied voltages are equal ( $E_1 = E_2$  in Fig. 2-a), the total d.c. voltage across both resistors is zero, since the resistors are connected back-to-back. The bias applied through R1 and R2 to the grid of the 6AC7 reactance tube is the -2 volts supplied to the lower end of R4.

Suppose now that the frequency of the local horizontal sweep oscillator becomes less than that of the incoming sync pulses. The position of the pulses on the combined wave applied to the

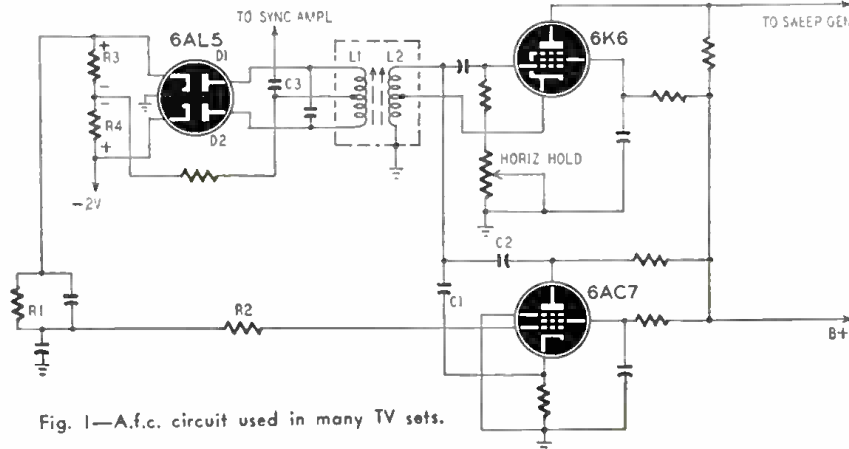

Fig. 1—A.f.c. circuit used in many TV sets.



diode plates shifts as in Fig. 2-b. The positive voltage applied to D1 exceeds the voltage applied to D2. Thus, the voltage across R3 becomes greater than that across R4, and the d.c. drops no longer cancel. There is a net positive voltage left over which cancels part of the negative bias voltage and thus reduces the 6AC7 grid bias.

The reduction allows the plate current to increase, causing the tube to act like an inductance of smaller value (shunted across L2), raising the operating frequency of the oscillator and

(of the sawtooth) is balanced by the current flow on negative half-cycles.

Let us now consider the condition with both voltages (pulse and sawtooth) applied simultaneously to the diodes D1 and D2. If the pulses occur while the sawtooth voltage is passing through zero, as is desired, there is still no d.c. voltage between point A and ground, since the average voltage applied to each diode is equal.

Suppose, however, that the frequency of the local sweep changes so that the pulses are no longer in step with the

If the shift should occur in the opposite direction—if the sync pulses should occur while the sawtooth is negative—D2 conducts more heavily than D1, and there is a net negative voltage between point A and ground. This negative voltage, amplified by the direct-coupled triode and applied to the grid of the multivibrator, causes a frequency shift in the opposite direction, again bringing the sweep back into step with the sync pulses.

One of the simplest a.f.c. circuits, that used in late versions of the Motorola VT-71 television receiver, is shown in Fig. 4. This a.f.c. circuit applies a d.c. voltage to the grid of a blocking oscillator, thus controlling its operating frequency.

The sync pulses delivered by the sync amplifier tube excite the tuned primary circuit L1-C1 of transformer T. The sine-wave voltage appearing across the secondary winding L2 is applied to the diode. This sine wave appears as in Fig. 5-a.

At the same time a sawtooth voltage (Fig. 5-b) from the horizontal sweep output is applied to a differentiating circuit consisting of R2 and C2. The pulse (Fig. 5-c) appearing across R2 is applied to the diode in series with the sine-wave voltage, so that the final voltage appearing across the diode is a combination of pulse and sine wave as in Fig. 5-d.

The diode conducts only when its plate is positive, however; therefore, the d.c. voltage appearing across diode load resistor R3 depends upon the amplitude of the applied a.c. voltage shown in Fig. 5-d. The d.c. voltage across R3 determines, in part, the operating frequency of a blocking oscillator used to produce the sawtooth sweep.

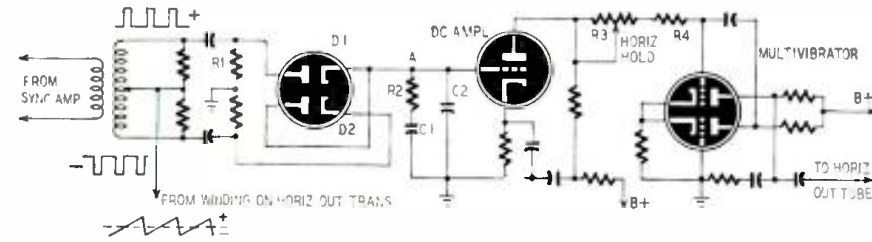

Fig. 3—A.f.c. circuit which controls operating frequency of a multivibrator sweep oscillator.

bringing it back in step with the incoming sync pulses.

Should the frequency of the horizontal sweep oscillator drift in the opposite direction (Fig. 2-c), the opposite action would occur to correct the error.

We see, therefore, that this a.f.c. circuit is quite similar to the a.f.c. circuits sometimes used to control the local oscillators in superheterodyne receivers. A reactance tube is shunted across the tuned circuit of the local oscillator, and the reactance tube is controlled by a d.c. voltage obtained from a discriminator.

An a.f.c. circuit used to control the operating frequency of a multivibrator sweep oscillator is shown in Fig. 3. A circuit similar to this has been used in some General Electric and Stewart-Warner receivers.

The pulses from the sync amplifier are fed to the transformer, which has a center-tapped secondary connected to diodes D1 and D2. A positive pulse is applied to the plate of D1, and a negative pulse to the cathode of D2.

When the plate of D1 is positive, the current flow is from the cathode to the plate of D1, through R1 to ground, and from ground through C1, R2, and C2 back to the cathode. At the same time, however, the cathode of D2 is negative, and the current flow from this diode through R2, C1, and C2 is in the opposite direction. Thus, with only the sync pulses applied, the current flows through R2, C1, and C2 cancel, and no voltage appears between point A and ground.

A sawtooth voltage obtained from a winding on the horizontal output transformer is also applied to the diodes. Diode D1 conducts on the positive half of the sawtooth, and D2 conducts on the negative half-cycles. If the time constant of R2, C1, and C2 is large enough, the average d.c. voltage between point A and ground will remain at zero, since the current flow on positive half-cycles

sawtooth signal—that is, suppose that the sync pulses no longer occur when the sawtooth is at zero.

If the sawtooth or the pulses shift in frequency so that the pulses occur

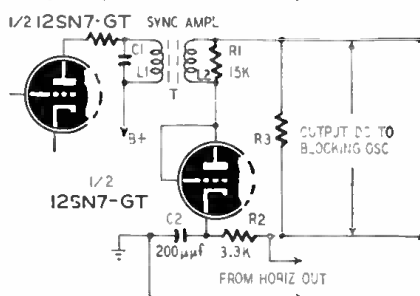

Fig. 4—Simple a.f.c. used in Motorola VT-71.

while the sawtooth is positive, then diode D1 receives a higher positive voltage than D2 and conducts more heavily. The currents flowing through R2, C1, and C2 no longer cancel. The result is a positive voltage from point A to ground.

This positive voltage is amplified by the triode d.c. amplifier and applied to the multivibrator sweep oscillator through R3 and R4, changing the sweep frequency and bringing the sweep back into step with the pulses.

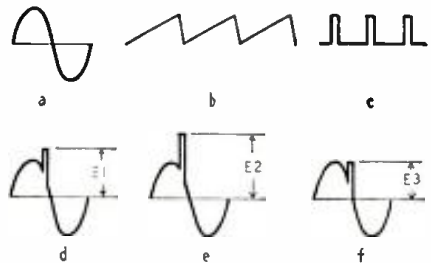

Fig. 5—Wave shapes for VT-71 a.f.c. system.

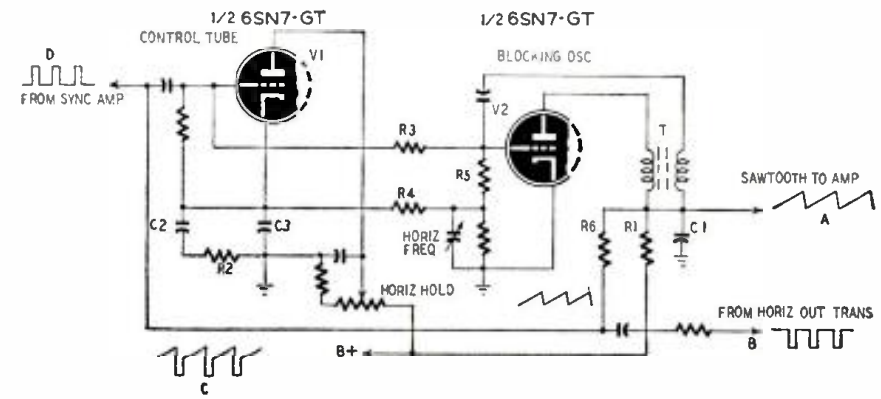

Fig. 6—Horizontal automatic frequency control circuit used in newer RCA and GE TV sets.

Ripple components of the d.c. across R3 are bypassed with a capacitor (not shown).

Suppose, now, that the sweep frequency becomes greater than the sync frequency. The pulse derived from the sawtooth sweep then occurs sooner and "rides" up the sine wave as shown in Fig. 5-e, increasing the peak voltage E2 applied to the diode. This increases the d.c. voltage across R3.

The increased bias voltage across R3, applied to the grid of the blocking oscillator, lowers its operating frequency, bringing the pulses back into step with the sine-wave signal.

If the sweep frequency becomes lower, the pulse position shifts in the opposite direction as shown in Fig. 5-f, and the voltage across R3 is reduced, allowing the blocking oscillator to speed up.

Loading resistor R1 broadens the response of tuned circuit L1-C1 so that its frequency response will not be too sharp, nor the component values critical.

One of the newer horizontal a.f.c. circuits, used in later model RCA and G-E television receivers, is shown in Fig. 6.

Half of a 6SN7-GT (V2) is connected as a blocking oscillator, discharging capacitor C1 (charged through R1) periodically and producing the sawtooth sweep voltage A which is applied to the horizontal sweep amplifier tube. Transformer T provides the feedback between plate and grid circuits necessary for blocking oscillator operation.

The frequency of the oscillator is controlled, in part, by the d.c. bias voltage applied to its grid. As the bias voltage is increased, the operating frequency is reduced and *vice versa*.

The high negative d.c. voltage present on the grid of the blocking oscillator is applied through resistor R3 to the grid of V1; therefore, this tube is normally cut off. Also applied to the grid of V1 (through R6) is the sawtooth sweep A and a pulse B obtained from the horizontal output transformer. The negative-going pulse and the sawtooth signal combine to give a trapezoidal wave C.

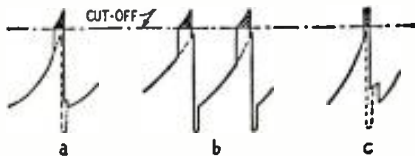

Fig. 7—A-c signal applied to grid of V1 (Fig. 6) for several horizontal oscillator conditions.

Positive sync pulses D from the sync amplifier are also applied to the grid of the control tube so that the resulting a.c. signal on the grid of this tube is as shown in Fig 7-a. The tube conducts only when the combined signal goes sufficiently positive to overcome the high negative bias. Thus, the control tube conducts only during the small positive pulses (shaded) in Fig. 7-a.

When the control tube conducts, the

low-pass filter network C2-R2-C3 (Fig. 6) is charged due to cathode-current flow. The amount of d.c. voltage developed across this network depends upon the time during which the tube conducts (and hence upon the width of the positive pulses).

The d.c. voltage appearing across this network is applied through R4 and R5 as bias to the grid of the blocking oscillator and thus helps to determine its operating frequency.

When the sweep oscillator is in sync with the incoming pulses, the sync pulses fall partially into the negative peaks of the trapezoidal wave shown dashed in Fig. 7-a.

Suppose, now, that the frequency of the local oscillator drops below that of the incoming sync pulses. The sync pulses no longer fall partially into the negative peaks of the trapezoidal wave, and the positive pulse width becomes greater as shown shaded in Fig 7-b.

When this happens, the control tube conducts over a longer period of time, and the positive voltage across network C2-R2-C3 becomes greater. This positive voltage (with respect to ground) reduces the grid-bias voltage on the blocking oscillator, allowing it to speed up and come back into step with the incoming sync pulses.

On the other hand, if the frequency of the blocking oscillator becomes greater than that of the incoming sync pulses, then the pulses fall more into the negative peak as shown in Fig. 7-c. The positive pulse width applied to the grid of the control tube becomes smaller as shown shaded in Fig. 7-c, and the tube does not conduct over as long a period of time.

In this case, the voltage across the filter network becomes smaller, allowing the negative bias to increase, and the frequency of the sweep oscillator is reduced, again bringing it back into sync.

The present tendency in television receiver design is to reduce cost without impairing performance by using fewer tubes and components, at the same time employing more efficient and simpler circuits. This tendency is demonstrated in the last two horizontal a.f.c. circuits (Figs. 4 and 6). Note that both of these circuits use only one tube in addition to the oscillator tube, compared to the two or more tubes employed in the earlier circuits.

## TV STATION LIST

Stations on the air May 20, 1949

City	Call	Channel
Albuquerque, N. Mex.	KOB-TV	4
Atlanta, Ga.	WAGA-TV	5
Atlanta, Ga.	WSB-TV	8
Baltimore, Md.	WAAM	13
Baltimore, Md.	WBAL-TV	11
Baltimore, Md.	WMAR-TV	2
Boston, Mass.	WBZ-TV	4
Boston, Mass.	WNAC-TV	7
Buffalo, N. Y.	WBEN-TV	4
Chicago, Ill.	WBKB	4
Chicago, Ill.	WENR-TV	7
Chicago, Ill.	WGN-TV	9
Chicago, Ill.	WNBQ	5
Cincinnati, Ohio	WKRC-TV	11
Cincinnati, Ohio	WLWT	4
Cleveland, Ohio	WEWS	5
Cleveland, Ohio	WNBK	4
Columbus, Ohio	WLWC	3
Dayton, Ohio	WHIO-TV	13
Doyton, Ohio	WLWD	5
Detroit, Mich.	WJBK-TV	2
Detroit, Mich.	WWJ-TV	4
Detroit, Mich.	WXYZ-TV	7
Erie, Pa.	WICU	12
Fort Worth, Tex.	WBAP-TV	5
Houston, Tex.	KLEE-TV	2
Los Angeles, Calif.	KFI-TV	9
Los Angeles, Calif.	KLAC-TV	13
Los Angeles, Calif.	KNBH	4
Los Angeles, Calif.	KTLA	5
Los Angeles, Calif.	KTSL	2
Los Angeles, Calif.	KTTV	11
Louisville, Ky.	WAVE-TV	5
Memphis, Tenn.	WMCT	4
Miami, Fla.	WTVJ	4
Milwaukee, Wis.	WTMJ-TV	3
Newark, N. J.	WATV	13
New Haven, Conn.	WNHC-TV	6
New Orleans, La.	WDSU-TV	6
New York, N. Y.	WABD	5
New York, N. Y.	WCBS-TV	2
New York, N. Y.	WJZ-TV	7
New York, N. Y.	WNBT	4
New York, N. Y.	WPIX	11
Philadelphia, Pa.	WCAU-TV	10
Philadelphia, Pa.	WFIL-TV	6
Philadelphia, Pa.	WPTZ	3
Pittsburgh, Pa.	WDTV	3
Richmond, Va.	WTVR	6
Salt Lake City, Utah	KDYL-TV	4
San Diego, Calif.	KFMB-TV	8
San Francisco, Calif.	KPIX	5
San Francisco, Calif.	KGO-TV	7
Schenectady, N. Y.	WRGB	4
Seattle, Wash.	KRSC-TV	5
St. Louis, Mo.	KSD-TV	5
St. Paul, Minn.	KSTP-TV	5
Syracuse, N. Y.	WHEN	8
Toledo, Ohio	WSPD-TV	13
Washington, D. C.	WMAL-TV	7
Washington, D. C.	WNBW	4
Washington, D. C.	WOIC	9
Washington, D. C.	WTTG	5

## TELEVISER CONTEST CLOSES SEPTEMBER 1

The \$100-prize television receiver contest announced by RADIO-ELECTRONICS in the May issue closes at noon on September 1, 1949, according to contest Rule 8, which you will find on page 20 of your May copy. September is not too far off, so this is a reminder to get to work.

Here is a brief summation of the rules to refresh your memory:

The purpose of the contest is to encourage simpler television circuits; so the fewer the tubes the better the rating (Rule 1). C-R and rectifier tubes don't count but crystals used instead of vacuum-tube diodes will count as half a tube each.

Don't send in the set: send photos and written description (Rule 2) plus, of course, schematic. The set need not cover both bands (Rule 3), but it must receive audio as well as video. *The winner keeps his set* but descriptions and photos become our property (Rule 4). Space rates will be paid for the story in addition to the prize. You must build a set: mere ideas will not be accepted (Rule 6).

Good luck!

# 14-Tube British Televiser

**A new a.c.-d.c., t.r.f. set gives 63-square-inch image at cost of only about \$150**

By MAJOR RALPH W. HALLOWS

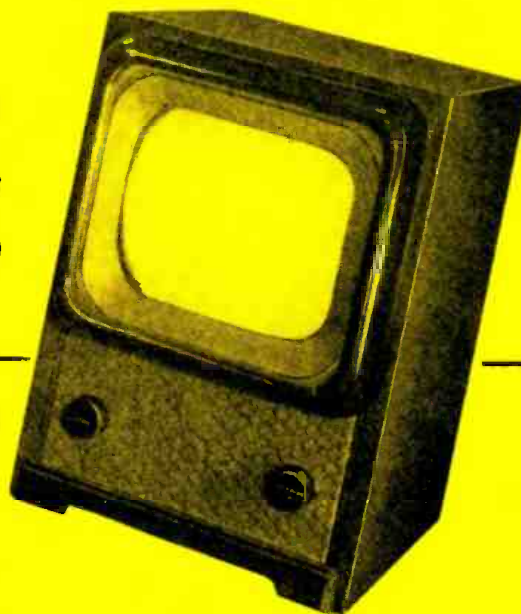

PERHAPS the most interesting British televiser on sale today is the "His Master's Voice" table-model type 1807. It is by far the cheapest of its class for I know of no other sound-and-vision receiver showing a 63-square-inch picture at a price approaching that of this H.M.V. model (\$150.00).

Its low price, however, is very far from being its only point of interest. Actually it contains a number of novel features, some of which are highly original and all of which are striking. Here are a few of them:

1. It is a genuine a.c.-d.c. instrument giving equally good results with either alternating or direct current.

2. It provides both vision and the accompanying sound reception with only 14 tubes.

3. Its power consumption is only 130 watts, so it operates economically.

4. It weighs only 30 pounds, and its size is but 19½ x 13¾ x 19 inches. Therefore it is readily transported by automobile and can be operated from a wall socket anywhere in an area covered by TV transmissions.

5. It incorporates the new Emiscope cathode-ray tube with an aluminum-backed screen which, for a given anode voltage, has about twice the brilliance of standard types.

6. It has a permanent-magnet focusing system that is so stable that it seldom needs more than very incidental attention.

7. Several other controls have been just as successfully stabilized—contrast, width, horizontal hold, height, and vertical hold.

8. The result is that there are only two knobs at the front of the set. One operates a combined on-off switch and brightness control. The second controls

the volume. All other controls are grouped at the back of the set.

Since the H.M.V. Model 1807 is manufactured in England for the home market, it was designed for BBC's 405-line, 50-frames-per-second, positive-picture modulation system. The design, though, should be readily adaptable for working on other TV systems.

One circumstance that helps to make

possible the cheapness and simplicity of this set is that only one station is on the air in any area of Britain. (At present only the London station is operating but others will open in the not-too-distant future.) That eliminates the bulky and expensive tuners, turrets, and ingenious but complicating channel selectors necessary for reception in the U. S. Selectivity isn't very important over

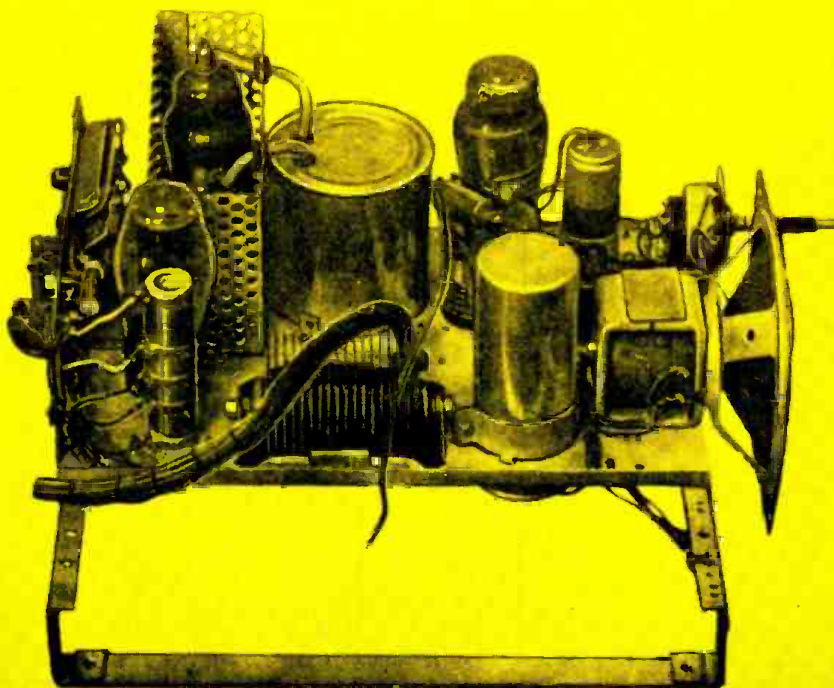

The power-audio chassis of the 1807 contains the dry-disc rectifier, amplifier, and speaker.

here either so a fixed-tuned t.r.f. circuit will do all the r.f. work that's needed.

The primary of the antenna transformer T1 is so arranged that it works equally well with co-axial cables or ribbon-type transmission lines.

V1 and V2 act as r.f. amplifiers for

both audio and video signals. The signals are separated at the output of V2. The sound signal is taken from the cathode through T2, and the vision signal from the anode through T3. The circuit L1-C1 is a trap tuned to reject the audio signal. V3 is the vision r.f.

amplifier, and V6 the sound r.f. amplifier. The diode plates of V7 are strapped together and form the sound detector. The voltage across the diode load is fed to the grid of the triode section of the tube for a.f. amplification. V8 is a conventional output pentode.

The output of V3 goes to the vision detector V4, one half of a dual diode. The video amplifier V5 uses a novel arrangement. Additional bias is provided by bleeding the current from the hold and brightness controls through the cathode resistor R1 to allow maximum grid-voltage swing. Direct coupling is used between V5 and the cathode of the C-R tube.

R2 takes the sync pulses from the plate of V5 to the sync separator V9. The sync pulses arrive as positive voltages on the grid of V9 and drive the

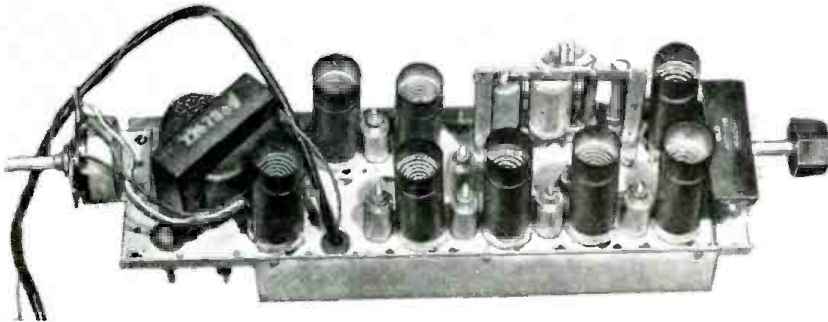

The video chassis. The single front-panel picture control—brightness—projects at right.

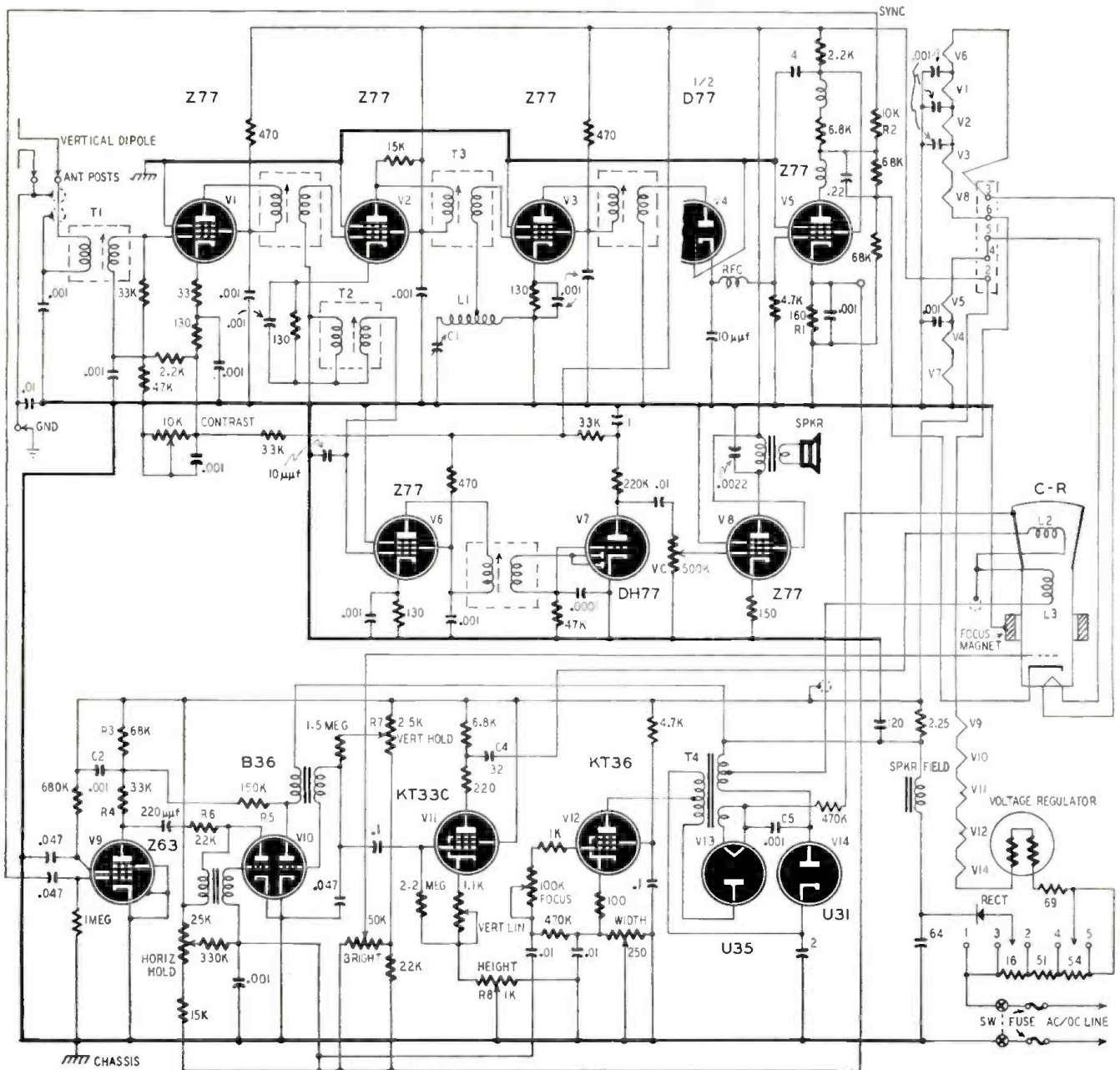

This is the complete 14-tube audio-video-power circuit. Notice simplicity of diagram compared to most others. Set is fixed-tuned t.r.f.

## Conditions Affecting TV Image Resolution

By NATHANIEL RHITA

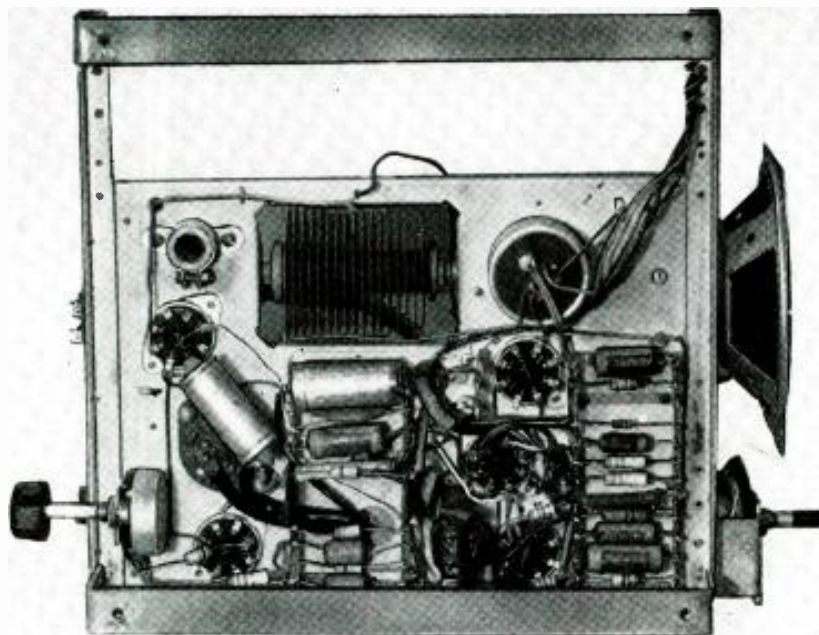

Underside view of audio-power chassis. Volume control, right, is operated from the panel.

tube into the grid-current region, thus producing a negative bias across the grid resistor. The picture signals, being of negative voltage, drive V9 beyond its cutoff point. The double-triode V10 generates the line and frame oscillations. The frame oscillator is triggered by the pulses reaching its anode through the integrating circuit C2, R3, and R5. The line-oscillator is fed by the differentiating circuit R4, R6, and the 220- $\mu$ f capacitor. A cost-saving measure which works very satisfactorily is taking the drive voltages for the frame output (V11) and line output (V12) tubes from the grids of V10.

R7 controls the frame oscillation frequency and forms the vertical hold control, while R8 in the cathode circuit of V11 governs the amplitude and forms the height control. The vertical linearity control is preset.

The output of V11 is fed through C4 to the frame deflector coils L2, and that of V12 is fed to the line deflector coils through the transformer T4. When V12 cuts out, a surge voltage is set up across the primary and auxiliary windings of T4. This voltage, rectified by V13 and smoothed by C5, is fed to the anode of the C-R tube.

The only remaining feature of the circuit calling for comment is the use of the diode V14. This is used to damp and rectify the overswing voltages present in the secondary of T4 and to apply them as additional B-voltage to the plate of V12.

Permanent magnetic focusing is now being used in a number of British televisions. This method of focusing is based on the fact that for a given electron velocity—which depends directly on the anode voltage—a magnetic field of a definite intensity will produce a sharply focused spot on the C-R tube.

In this set, the focusing magnet is

designed and placed to produce a sharply focused spot with approximately 5 kv on the anode. The focus control, in conjunction with the cathode capacitance of the line output tube, controls the line flyback period. Therefore, it also controls the anode voltage obtained by rectifying the surge voltage across the primary of the output transformer. The focus control is varied until the anode voltage is correct for the focusing magnet used.

In my opinion, the H.M.V. 1807 marks an important forward step in televiser design and construction. It shows how good reproduction of both the sound and the vision broadcast by TV stations may be obtained with a modest number of tubes used in ingenious but inexpensive circuits. It proves, in a word, that "television for all" is no mere figure of speech.



How chassis and tube are set in the cabinet.

THERE is considerable difference in quality between a photograph and TV picture. Photographic film has very fine grain. It can be enlarged many times to disclose more picture detail. TV is more limited. Regardless of image size there are less than 500 picture elements or lines from top to bottom. A photo or magazine half-tone may be observed satisfactorily at less than arm's length; TV requires a much greater minimum viewing distance.

The minimum distance for a 10-inch kinescope (about 6 x 8-inch picture) is approximately 4 feet. This distance varies in proportion to kinescope (or projected image) size. Beyond this minimum distance the individual picture elements begin to blend together to form a "solid" image. Poor vision permits a shorter distance for satisfactory viewing, of course.

Unlike film, TV images may have different degrees of vertical and horizontal definition. The first is fixed by FCC standards at 525 horizontal lines per image. About 7% of these are lost during blanking periods. (Incidentally, this is considerably better than the British standard of 405 lines.) The kinescope spot must be small enough to resolve or bring out each individual line. This is easily done with a correctly focused beam, except in the small 3-inch and possibly the 5-inch tubes.

Horizontal definition depends upon receiver bandwidth. If the band is too narrow the beam intensity cannot change rapidly, therefore fewer picture elements can be resolved. The result is a fuzzy or "soft-focus" outline where there should be a sharp one.

Vertical resolution may be checked by observing the raster. Each horizontal line should appear distinct. The beam should be focused for maximum sharpness.

Horizontal resolution may be checked with standard TV test patterns, especially the vertical wedges. The thin lines are resolved near the bull's-eye if the receiver bandwidth is 4 mc or more. At the outer end of the wedges, the lines are twice as thick. A bandwidth of about 2 mc will bring these out. In any case interference and ghosts may distort the pattern and give the effects of a narrow band.

The aspect (width-height) ratio of a TV image is 4 to 3. Since the vertical resolution is fixed at 490 lines, there must be 653 resolved elements across the screen for equally good horizontal resolution. This is equal to 325 complete cycles in 53 microseconds, the time needed for the beam to cross the screen. There are 6 cycles per microsecond, so the required bandwidth is 6 mc per second. Since TV receivers have less bandwidth than this, their vertical resolution is better than the horizontal.

# ANTENNAS ☆ ☆ ☆

## A roundup of television arrays



GONSET WW

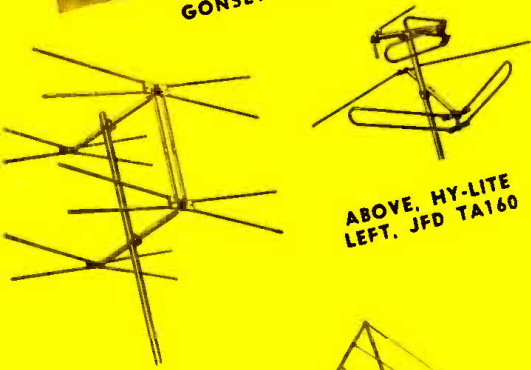

ABOVE, HY-LITE  
LEFT, JFD TA160



VEE-D-X

ANTENNA RESEARCH LAB.

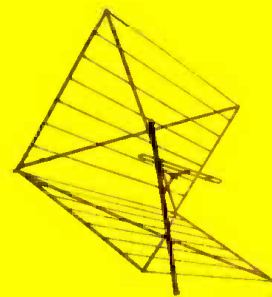

TRICRAFT 1000

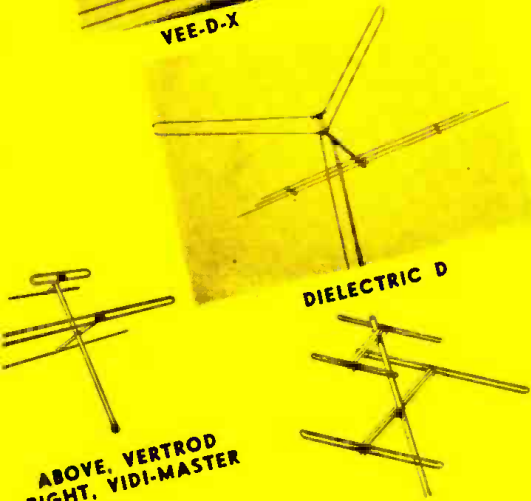

DIELECTRIC D

ABOVE, VERTROD  
RIGHT, VIDI-MASTER

WITH television stations spreading like wildfire across the land and receiver installations following them, a chief interest of every receiver owner and installation man is video antennas. Manufacturers are responding to the demand with a variety of styles, qualities, and arrangements, ranging from the simplest dipole to the most elaborate arrays—semblies that before the war would have been expected only at some high-frequency-research laboratory or possibly atop the shack of some learned and super-ambitious ham.

The problem of television reception is basically a very simple one. But like so many uncomplicated procedures, the little there is to be done must be done right. The antenna must intercept a satisfactory amount of energy; the energy it takes must come from a single source to avoid ghosts; and it must provide a reasonably good match to its transmission line. To satisfy these conditions in locations with widely differing characteristics, there are arrays with more or less gain, sharper or narrower acceptance angles, smaller or broader bandwidths, and impedances to match various types of line. To top off the lineup, there are masts, mounts, towers—all the simple but indispensable accessories that add the finishing touches to an expert and effective installation.

No one antenna is better, *per se*, than any other, assuming both are designed with established engineering principles in mind. It all depends on where you live and what your physical facilities are. A simple dipole may perform as well in a city living room as a 16-element beam on a 50-foot tower in the country.

So let's look over the field and see what's being offered.

### Outdoor arrays

A variation from conventional dipole design, the All-channel Antenna Model WW (Gonset Co., Burbank, Calif.) has substantially uniform response on all channels while maintaining directivity. When used with 300-ohm line, the standing-wave ratio is low. The elements and mast are made of aluminum alloys. A reflector kit is made for locations with severe ghost problems.

Another variation from conventional dipole arrangement is the stacked array of "conical" elements (see photo) made by JFD Manufacturing Co., Inc., numbered TA160. The units may be made into single-element antennas or used with a reflector or stacked. Standing-

wave ratio is low on all TV frequencies.

Stacking kits, numbered 114-301 and 114-302 are made by American Phenolic Corp., Chicago, under the Amphenol label. These are single- and double-bay assemblies, each consisting of a high- and low-band folded dipole and reflector, plus symmetrical feeding bars and hardware.

An antenna-and-reflector array is made by Oak Ridge Antennas. Intended for fringe-area reception and called the Fringemaster, its front-to-back ratio is 4 to 1.

A four-element array offered by La-Pointe Plascomold Corp. of Unionville, Conn., under the Vee-D-X trade name, is a variation on the design of the Japanese scientist, Yagi. The driven element matches 300-ohm line and the antenna has a high front-to-back ratio. Elements are made of duralumin, the parasitic elements 1 inch in diameter on the low-band arrays and ½ inch on the high. Each array is cut for a specific channel; several may be mounted on one mast.

A folded-dipole-and-reflector unit called Snap-out is made by Hy-Lite Antennae, Inc., Bronx, N. Y., consisting of three pieces—the upper- and lower-band folded-dipole-and-reflector assemblies and the mast. The elements fold up, as the picture shows, so that the installation man need only unfold them, rather than take time to assemble individual pieces of hardware.

The 4' n I made by Vertrod Corp., New York, is a folded-dipole-reflector assembly, with separate arrays for high and low bands. It is more versatile than the usual antenna, however, as it may be connected for 72- or 300-ohm line and is assembled with thumbscrews—no tools are needed.

The Simpli-Flex antenna made by Radiart Corp., Cleveland, Ohio, consists of basic folded-dipole-reflector assemblies for low and high bands. The units can be combined in any desired multiple array.

The ARL-12 (Antenna Research Laboratory, Inc., Columbus, Ohio) consists of a folded dipole in a corner reflector. It is effective over all channels and matches 300-ohm line. According to the maker, standing-wave ratio varies from 6.75 to 1, and the directivity gain over a half-wave dipole ranges from 6.5 to 13. The weight of the unit is about 30 lb., and its dimensions are roughly 9 x 6 x 3½ feet. A 10-foot mast is supplied.

A multiple-reflector array made by Tricraft Products Co., Chicago, Model 1000 has very narrow beam width and gives more than 10 db gain over a half-

wave dipole in the high band. Gain in the lower band is 5.5 db.

The **Duoband model D antenna**, made by **Dielectric Products Co., Inc.**, Jersey City, N. J., is basically a folded dipole with reflector. The folded dipole, cut for the low band, is bent to a 90-degree angle, with the result that both high- and low-channel signals are picked up with almost equal gain and directivity. Three reflectors complete the assembly. These are tuned to the three low-band channels in use in the area; reflectors for any of the lower channels are available. Models for either 300- or 75-ohm line are made.

The **Vidi-Master antennas**, made by **Communication Measurements Laboratory, Inc.**, New York, are available in three models, all-band, high-band, and low-band. Two folded dipoles of unequal length are driven by a phasing section in a close-spaced array. Front-to-back ratio is said to be higher than that of other two-element, broad-band arrays. Models are 73, 74, and 88.

An especially interesting antenna is **RCA's** reversible beam. Front-to-back ratio is so great that for practical purposes it can be assumed to be unidirectional. The direction can be reversed at will, however, by a switch near the televiser. This is made possible by a diplexer, a bridge made of four quarter-wave lines, one of which is transposed. An absorbing resistor and the receiver are connected to the two pairs of bridge terminals. Four dipoles are arranged in the form of a square (see photo) and connected to the diplexer. Open-wire V's attached to each dipole effectively shorten them for reception of high-band signals, so that all TV channels are received well.

#### Indoor and window aerials

**Camburn, Inc.**, Woodside, N. Y., is the maker of the indoor telescoping dipole (**Majorette Model TA59**) shown in the photo. The arms can be extended to a total half-wave on the lowest channel. They can be spread out or moved in to a V, as shown.

Similar indoor V antennas are made by **Radion**, Chicago; **JFD Manufacturing Co., Inc.**, Brooklyn, N. Y. (**the Tele-Vee**); **Oak Ridge Antennas**, New York; **Insuline Corp. of America** (**the Wasp**); **Philson Manufacturing Co., Inc.**, New York (**the Porto-Tele**); **Delson Manufacturing Co.**, New York (**Jiffy Junior**); **Ward Products Corp.**, Cleveland, Ohio (**TVI-49**); and **Electro-Steel Products, Inc.**, Philadelphia, Pa. (**Flextron IN-102**).

The **Slide-Rule Antenna**, made by **The Radio Craftsmen, Inc.**, Chicago, Ill., is

a modified folded doublet. It consists of a round base with steel tape, calibrated in TV channel numbers, coming out the sides as shown in the photo. A lever actuates a spring mechanism, automatically rolling the tape back into the base when listening is completed.

Made by **Electro-Steel Products, Inc.**, the **Flextron**, consists of an insulated base and three square aluminum-rod assemblies. The ends of the front square are connected to 300-ohm transmission line and one end of each of the others is wired through a switch in the base to one side of the line. In use, the switch is thrown to the position giving the brightest picture.

Two similar window antennas are made by **Delson Manufacturing Corp.**, (**Model B62**) and **Oak Ridge Antennas** (**the Window-Tenna**), both of New York. Each of these consists of two dipoles, one for the lower and one for the upper television bands. The smaller dipole may be oriented independently of the larger.

The units are fixed to a window frame with jack bars, which are set in place and then expanded until the fit is safely tight.

#### Accessories

Towers of light weight, high strength, and low cost are being made by **Alprocco, Inc.**, Mineral Wells, Tex. Of triangular construction, the tower sections are each 6 feet long; any number can be bolted together to form high towers. Spring-tempered aircraft aluminum brings the weight down to 1 lb. per foot.

The **Model 200 tower** made by **Easy-Up Tower Co.**, Racine Wis., is a triangular-type, prefabricated-steel TV antenna design for either residential or commercial use. Antenna height of 40 feet above rooftop is reached with the basic three-section tower anchoring a 10-foot pole.

New, low-cost towers for supporting TV and FM receiving antennas atop a roof are made by **Wincharger Corp.**, Sioux City, Iowa. They are self-supporting, requiring no guy wires. The towers are built in two heights and accommodate a pipe extension which can be raised and lowered for installation and service. The towers will support antennas 10 or 20 feet above the roof. Laboratory tests show that the structures will withstand 70-mile-per-hour winds.

With the **Tenna-Rotor** (**Alliance Mfg. Co.**, Alliance, Ohio) a TV or FM antenna can be rotated to the position which gives optimum reception.

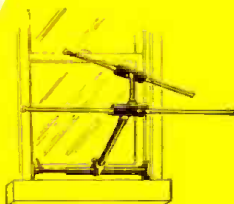

OAK RIDGE



ALLIANCE

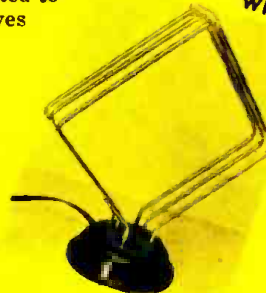

# A High-Fidelity Tuner-Amplifier

## PART I—TUNER

By M. HARVEY GERNSBACK

**A**T 3 O'CLOCK one afternoon 22 years ago, someone (I forget who) presented me with my first power output tube (a 71-A as I recall). At 6 o'clock it was installed, complete with extra plate and bias batteries, in my good old t.r.f. receiver. I turned the set on. At 6:01 the high-fidelity bug bit me. I've never completely recovered from that first attack, and periodically I have a recurrence of high-fidelity fever.

My last attack struck me while in the Army. Since I couldn't do anything about it then, I used my spare time to design postwar project No. 1, a high-fidelity t.r.f. broadcast receiver for high-quality, local AM reception.

The final job isn't quite like the one I laid out on paper in the Army, but it differs only in details. The lineal descendant of that 1927 job with the 71-A output, it represents two years of continuous after-hours' experiment and development by me and my chief assistant (see this month's cover).

The tuner section of the set (we'll get to the a.f. amplifier next month) contains two bandpass t.r.f. stages, 6SK7's (see Fig. 1). A four-gang capacitor tunes the bandpass circuit. Negative mutual coupling is used. As far as I know, Miller Coil Co. is the only firm making the coils.

The detector stage is untuned and uses a 1N34 crystal diode. Another 1N34 supplies a.v.c. A 6U5 tuning eye completes the tuner lineup.

The power supply (on a separate chassis—diagram in Fig. 2) is conventional, the only noteworthy thing about it being that it supplies 450 volts of d.c. at 170 ma at the input to the filter. We chose a slow-heating rectifier (a 5V4-G) to prevent this high voltage from being applied to the circuit before all the other filaments are warmed up. A quick-heating rectifier would bring the danger of breaking down filter and coupling capacitors.

The high-voltage, high-current supply is needed for the audio amplifier. For the 6SK7 grids, 2.5 volts of negative bias is developed across an 18-ohm, 2-watt resistor in the B-minus line. In our power supply all filter capacitors are 600-volt paper. Each capacitor may be made up from smaller-value units in parallel. Electrolytics can be used, of course, although they will probably require replacement every 3 or 4 years. Use at least double the amount of ca-

RADIO-ELECTRONICS for

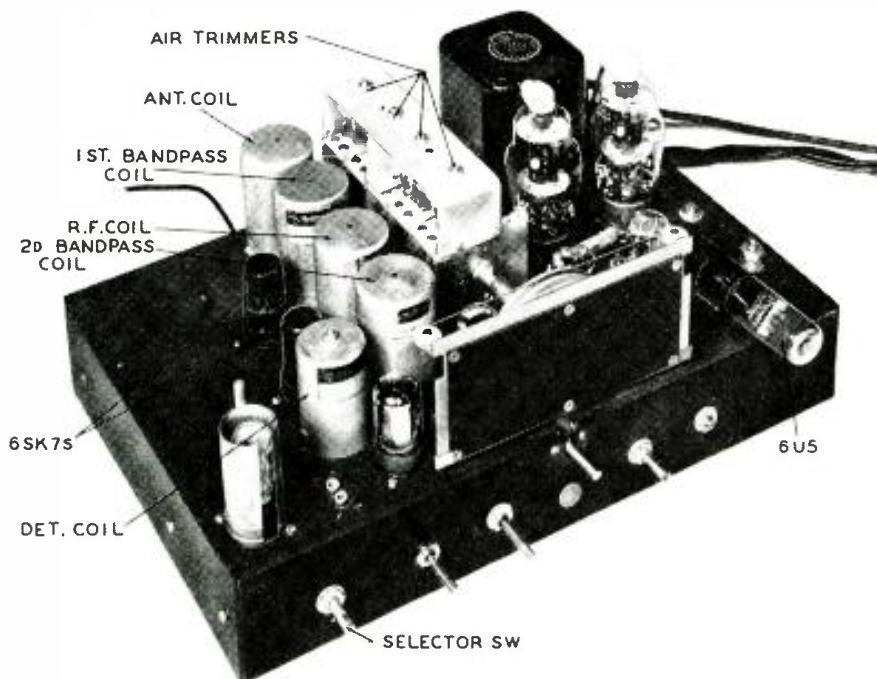

The hi-fi tuner-amplifier. Notice the special method of mounting the air trimmer capacitors.

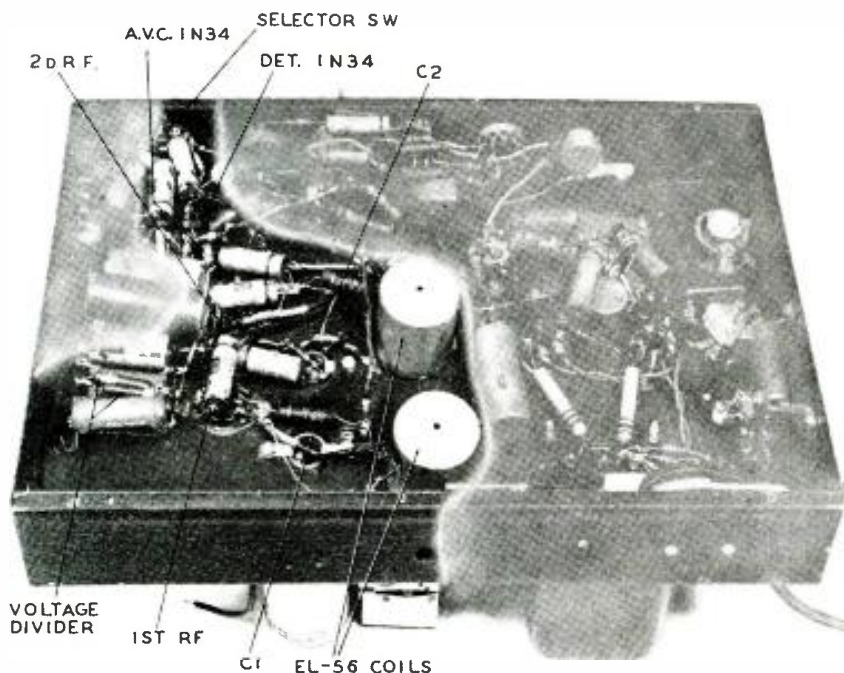

The chassis holds an 807 audio amplifier as well as the t.r.f. tuner. The tuner parts are shown and labeled, but the amplifier components are held under wraps in anticipation of an unveiling in next month's article. The chassis is 11 x 17 x 3 inches, mounts in a book case.



capacitance shown in the schematic if you use electrolytics. With the papers, this supply has been in use since 1935 with the same components!

Bandpass t.r.f. seemed the best idea because of its low noise and good selectivity without appreciable sideband cutting on any part of the broadcast band. I wanted to reproduce the whole spectrum put out by many metropolitan AM stations. (Contrary to popular belief, AM broadcasters *do not* have to cut off response above 5,000 or even 10,000 cycles; many good stations have flat response to above 10,000 cycles when broadcasting local programs or some of the better-quality transcriptions and records.) I also wanted to be able to separate the large number of local stations within 25 miles.

The negative-mutual-bandpass circuit pretty well meets these requirements, and, in addition, lends itself to simple adjustment of selectivity. Changing the value of capacitors C1 and C2 will do this. With .03- $\mu$ f units, bandwidth is about 25-30 kc. Increasing their size will sharpen tuning. If you want, you can use a three-position, double-pole switch to give three positions of selectivity (see dotted switch and capacitors in Fig. 1).

Since there are no cathode-bias resistors, a no-signal minimum bias of 2.5-3 volts must be provided for the 6SK7's. The 18-ohm resistor in the B—line of the power supply takes care of that. The negative voltage is applied in series with the 1N34 a.v.c. diode, and so to the 6SK7's. The 6U5 cathode is connected to the -2.5-volt line, too. If this is not done, the 6U5 will have a negative bias (in effect a delay bias) of 2.5 volts with no station tuned in and will not open completely. It will also fail to indicate the presence of weaker stations.

**The detector circuit**

The 1N34 detector diode is noteworthy chiefly for the very low value of load resistance used with it. During the development of the set, we set up a switching arrangement to make instantaneous listening comparisons between a diode and an infinite-impedance detector. The ordinary diode detector gets into distortion trouble with highly modulated signals (practically all broadcast programs have frequent, instantaneous, high modulation peaks). They show up unpleasantly on wide-range equipment. The infinite-impedance detector uses audio degeneration to get around the trouble. However, our listening tests showed that it wasn't perfect either; in fact the ordinary diode sounded better on a "blind-fold" test. We decided to try and improve the diode to reduce the trouble to negligible proportions.

The ratio of the diode's d.c. load resistance to its a.c. load determines the maximum modulation percentage it can handle without distortion. Ideally, the a.c. load should equal the d.c. load. In practice, if it is nearly as large as the d.c. load, low distortion will re-

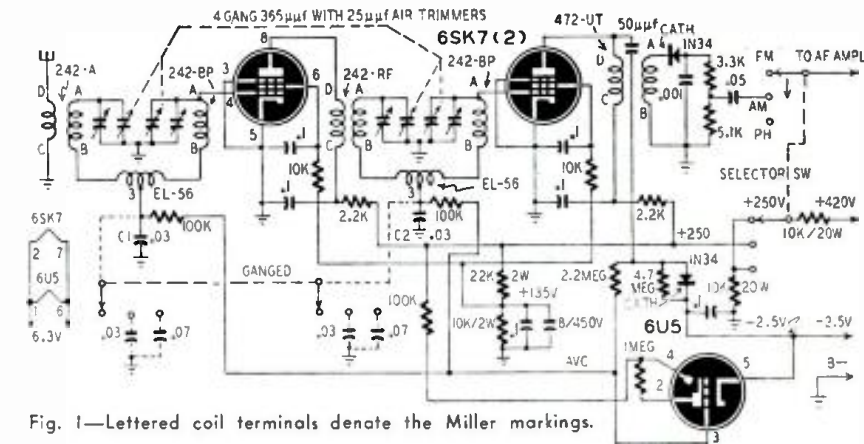

Fig. 1—Lettered coil terminals denote the Miller markings.

sult, even at high modulation percentages. Increasing the value of the grid resistor on the first audio tube will accomplish this effect. The grid resistor can be increased only so much, however.

Another dodge is to tap down the output of the diode so that the following audio load is across only a part of the diode load resistor. That, too, has its limitations because tapping down reduces signal level. However, there is yet another way of improving the ratio: decrease the value of the diode load resistor.

Designed to give linear rectification with much lower values of load resistance than a vacuum-tube diode, the 1N34 is a natural for this technique. We use a diode load resistor of only 8,400 ohms. To improve matters further, the audio output is tapped off part of the load resistor (tap is at 5,100 ohms from ground end). Since the grid resistor of the first a.f. stage is 500,000 ohms (for good high-frequency response), the a.c. load on the diode is nearly as large as the d.c. load of 8,400 ohms.

As an additional precaution to keep the diode's a.c. load as high as possible, a separate 1N34 is used to develop a.v.c. voltage. The r.f. voltage for the a.v.c. diode is taken from the plate of the second r.f. stage where it will have the least shunting effect on the detector diode.

**Construction**

Chassis layout was determined largely by the gang capacitor and the audio amplifier (which is also on the tuner chassis). Locations of the major parts of the tuner are indicated in the photos. The antenna, bandpass, r.f., and untuned detector coils are mounted on top of the chassis between the tuning capacitor and the 6SK7's. The tuning coils are mounted under the chassis.

The a.v.c. 1N34 is mounted under the detector coil with its 50- $\mu$ f coupling capacitor. The detector 1N34 is mounted adjacent to the detector transformer.

For greater stability, we use air trimmers, mounted on a bracket on top of the gang capacitor.

Regeneration will destroy the bandpass characteristic of the tuner. Here are several ways to avoid r.f. regeneration or oscillation trouble: First, mount the

0.1- $\mu$ f screen bypasses for the 6SK7's across the bottom of each tube socket so that each acts as a shield between plate and grid (pins 8 and 4). Second, if you run a ground-return line along the chassis for the r.f. stages, ground it to chassis mid-way between the two stages so that the ground returns of the two stages are not in series. Shield the plate leads to the 6SK7's. Ground the shields. Keep both plate and grid leads short (under 1½ inches) and close to the chassis.

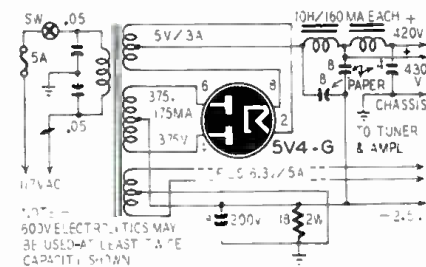

Fig. 2—Note paper capacitors in the filter.

Align the set at about 1500 kc for maximum output. If C1 and C2 are .03  $\mu$ f each, double-hump tuning is normal on stations below 900 kc. This can be seen clearly on the tuning eye. Adjust the slotted end plates of the tuning capacitors for best tracking on the low-frequency end of the band.

Since the set is intended for local-station reception, sensitivity is not high and an outdoor antenna is desirable. In suburban and rural areas, it's a necessity. In any location, the outdoor antenna reduces man-made noise by improving signal-to-noise ratio. This is vitally important if a wide-range speaker is on the audio end.

**MATERIALS FOR TUNER (FIG. 1)**

- Resistors: 2—2,200, 1—3,300, 1—5,100, 2—10,000, 3—100,000 ohms, 1—1, 1—2.2, 1—4.7 megohms, ½ watt; 1—10,000, 1—22,000 ohms, 2 watts; 2—10,000 ohms, 20 watts.
- Capacitors: 1—50  $\mu$ f, mica; 2—.03; 1—.05; 6—0.1- $\mu$ f, 600-volt, paper; 1—8- $\mu$ f, 450-volt, electrolytic; 1—4-gang, 365- $\mu$ f air variable; 4—25- $\mu$ f air trimmers, 1—.001- $\mu$ f ceramic.
- Tubes: 2—6SK7, 1—6U5/6G5.
- Miller coils: 1—242-A, 2—242-BP, 2—EL-56, 1—242-RF, 1—472-UT.
- Miscellaneous: 1—3-position, 2-circuit rotary switch; 2—1N34 crystal diodes; 2—octal, 1—6-prong tube sockets; chassis, diodes, hardware, etc.

**MATERIALS FOR POWER SUPPLY (FIG. 2)**

- 1—18-ohm, 2 watt resistor, (1—18  $\mu$ f, 200 volts, 2—.05, 1—4, 2—8  $\mu$ f, 600 volts, capacitors; 1—power transformer, 750 volts c.t., 175 ma, 6.3 volts, 5 amperes, 5 volts, 3 amperes; 2—filter chokes, 10 h, 160 ma; 1—s.p.s.t. toggle switch; 1—5-ampere fuse assembly; chassis, hardware, etc.

# Electronics in Medicine



(Courtesy Rahm Instruments, Inc.)

Variable frequency brain surgery stimulator.

**D**ISEASES of the nervous system have been recognized throughout history. Epilepsy is described in the Bible, and the ancient Greeks regarded it as the sacred disease. Yet today, after many centuries of study, the human nervous system is still one of the greatest mysteries of medicine.

The nervous system is like a gigantic and tremendously complex television network *without a schematic diagram!* In this network the brain corresponds to the central control panel, into which stream countless electronic signals (nerve impulses) over co-axial cables (nerve fibers) from remote pickup transmitters (eyes, ears, nose, and many other nerve endings throughout the body). The brain contains receivers, oscillators, transformers (nerve cells and fibers) which integrate all the signals coming into it and transmit signals (other nerve impulses) to the television receivers (muscles, blood vessels, and all other parts of the body) making them operate.

Admittedly, this explanation is a rather simplified version of what actually takes place. However, it has been shown, by attaching the input of a cathode-ray oscilloscope to nerves that nerve impulses are electrical in nature. And it is also known that cutting or damaging a nerve, or destroying its insulating sheath produces the same effect as cutting a wire—namely, an open circuit.

One of the important problems confronting the doctor is determining whether the nerve circuit to muscles is intact or, if it is damaged, to what extent. In solving this problem he is doing with the body what the radio technician does—signal tracing.

Every muscle in the body has one or more nerves which supply it with signals. This combination of muscle and nerve is like a loudspeaker and its output transformer, as shown in Fig. 1. The nerve corresponds to the input circuit. The transformer represents the

**Part IX—Electronic equipment used for muscle and nerve testing has circuits familiar to most radio-electronic technicians**

By EUGENE J. THOMPSON

junction of the nerve and muscle in the body (called the motor point), which adapts the input signal (nerve impulse) to the next stage (the muscle) to drive the speaker (making the muscle contract and lift the weight).

One way to test the continuity of the nerve-muscle circuit is to examine it electronically for the presence of a group of abnormal muscle responses known as the *reaction of degeneration*.

A dispersing and a test electrode are connected to the output of a galvanic-faradic stimulator (see page 32, February issue). The dispersing electrode is attached to a neutral part of the body. The test electrode is placed on the skin overlying the motor point (point of greatest excitability) of the nerve supplying the muscle(s). The circuit is closed, permitting the diagnostic current to flow through the body, and the effect on the muscle(s) is observed. This procedure is used with both galvanic and faradic currents. In the galvanic test, the test electrode must be connected to the negative terminal of the machine. Polarity is of no consequence when using the faradic current. The possible results of the tests are summarized in the table.

In normal muscle, it is of great importance, when using galvanic currents, whether the positive (anode) or negative (cathode) electrode is placed on the motor point and whether the circuit is being opened or closed. This is the basis for another test of nerve and muscle injury. The sequence in which normal muscle contracts is called the polar formula: C.C.C. < A.C.C. < A.O.C. < C.O.C.\*

This notation states that the muscle requires the least current to produce contraction when the cathode is placed on the motor point and the circuit is closed. A greater current strength is needed to produce contraction if the circuit is closed with the positive electrode (anode) over the motor point. If the muscle is to contract when the circuit is opened, with the anode on the

\* C.C.C.—Cathode-closing current.  
A.C.C.—Anode-closing current.  
A.O.C.—Anode-opening current.  
C.O.C.—Cathode-opening current.



Teco Corp's galvanic-sinusoidal stimulator.

motor point, an even greater current is required. The highest current is needed to produce cathode-opening contraction.

The usefulness of this test is that in nerve injury the normal order of the polar formula may be transposed.

The above tests are essentially qualitative procedures. More accurate measurement of nerve injury requires more refined techniques.

One procedure involves construction of a strength-duration curve, obtained

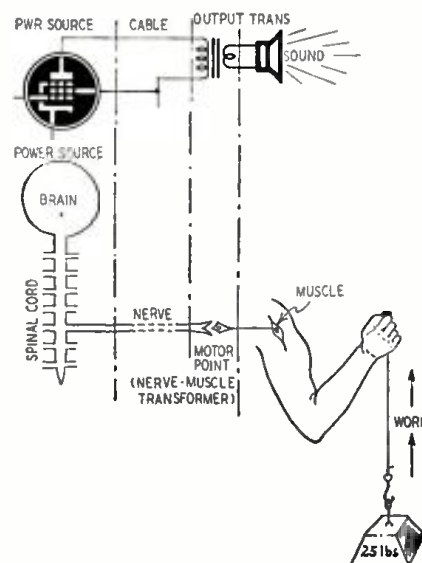

Fig. 1—Output stage vs.—nerve-muscle path.

RADIO-ELECTRONICS for

by applying a stimulus of accurately controlled duration to the motor point of the nerve. The current strength is slowly increased until the least perceptible muscle contraction appears. The process is repeated with a number of impulses of different durations. The curve then is compared with a known normal for evaluation.

Accurately timed pulsations (particularly impulses of very short duration) are readily produced with an R-C circuit in which the capacitor alternately charges and discharges across the resistance.

The instrument in Fig. 2, which is specifically designed for muscle testing, employs different capacitors to regulate the frequency of discharge. Applicable to strength-duration work because of its wide frequency range, it is also suitable for another measurement of nerve injury known as *chronaxie*.

Chronaxie is not an inherent property of nerve and muscle, but rather an artificial unit of muscle and nerve excitability. In order to produce muscle contraction, a current must flow for a definite minimum time. The weaker the current, the longer it must flow. However, for every muscle there is a certain current strength below which no contraction will take place even if the current flows for an infinite time. This minimum current, called the *rheobase intensity*, is defined as the lowest current flowing, without regard to time (theoretically infinite time), to produce muscle contraction.

Since the rheobase current is not related to time, doubling its intensity should produce muscle contraction when the current flows for a certain actual time. This time during which a current twice rheobase must flow to produce muscle contraction is called chronaxie. Normal chronaxie values for all the major muscles and nerves in the body have been established. Hence, to determine the extent of nerve damage, the chronaxie can be measured and compared with the normal value. The method will be described, using the instrument in Fig. 2.

Chronaxie is measured in *sigma* (thousands of a second). The negative (test) electrode is placed over the motor point, and the positive (dispensing) electrode over a neutral area. Straight galvanic current is then applied to the nerve by closing the circuit with S1 and leaving S2 in the neutral position. The current is gradually increased with R1, depressing S1 periodically until the lowest current which produces contraction (rheobase) is reached. This current is then doubled by adjusting R1, and the lowest-value capacitor is charged by throwing S2 to CH and closing the first capacitor switch. It is discharged through the patient by throwing S2 to DIS. The capacitance (and hence the duration) of the impulse, which equals  $R \times C$  is gradually increased by closing successive switches in the bank until muscle contraction occurs. The chronaxie is read from the panel of the instrument,

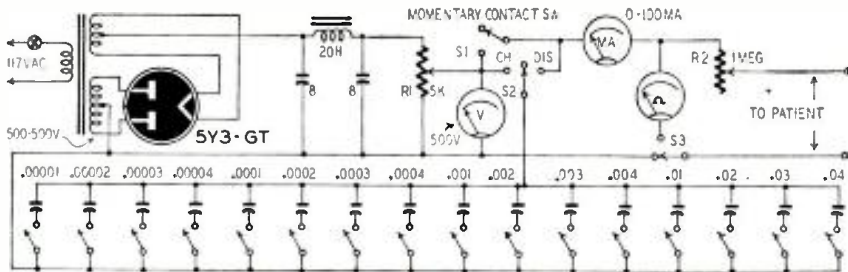
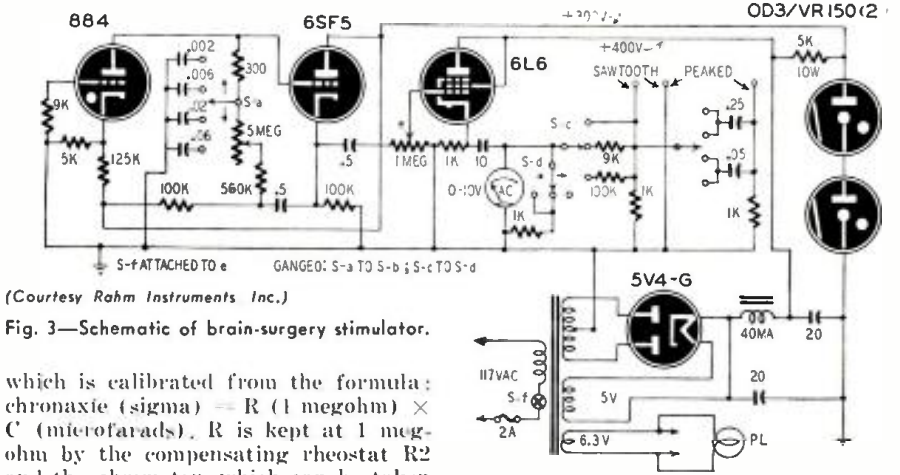

Fig. 2—Circuit developed by author for making chronaxie and strength-duration measurements.



(Courtesy Rahm Instruments Inc.)

Fig. 3—Schematic of brain-surgery stimulator.

which is calibrated from the formula:  $\text{chronaxie} (\sigma) = R (1 \text{ megohm}) \times C$  (microfarads). R is kept at 1 megohm by the compensating rheostat R2 and the ohmmeter, which can be taken in or out of the circuit with S3.

Two other methods of muscle and nerve injury diagnosis are the progressive current technique and the sinusoidal method.

In the first procedure, sawtooth waves are used, in which the rate of increase of the leading edge can be varied. In the second method, a.c. of varying frequencies is used—the lower frequencies having slower rates of current increase, and the higher frequencies faster rates. The basic principle involved in both is that muscles whose nerves are injured contract in response to the slowly increasing currents, whereas normal muscles respond to the rapidly rising impulses.

Once a particular disease condition

is diagnosed, the most important consideration is how to treat it effectively. Unfortunately, many diseases which afflict the nervous system cannot be cured with our present knowledge. However, there are some which can be remedied by brain surgery. Because of the complexities of the brain, some method for localizing the precise area to be operated on is often necessary. Fig. 3 is a schematic diagram of a stimulator which is used for this purpose.

Designed around the 884 thyatron, the instrument provides a frequency range of 12-2,000 cycles in four overlapping bands. The operator has a choice between sawtooth and peaked waves.

The 884 is followed by a 6SF5 triode to insure that the oscillator remains stable and that its frequency is not altered by changes in the loading or variations in the stimulus amplitude. The frequency response is further equalized by connecting the 6SF5 as a cathode follower.

The impedance of the surface of the brain is approximately 1,000 ohms, and its threshold voltage is about 5 volts. Since the 6SF5 cannot deliver 5 volts across a 1,000-ohm impedance, a 6L6 is used in the power output stage. In order to maintain the output at as low an impedance as possible to insure maximum power transfer, the output of the 6L6 is also delivered through a cathode-follower arrangement. The output is controlled by the 1-megohm potentiometer. The frequency is controlled by the ganged capacitor-selector switches and by the 5-megohm potentiometer in the 6SF5 grid circuit. A regulated power supply is used to increase the oscillator stability.

TABLE OF NERVE AND MUSCLE TESTS

Type of reaction	Current applied to	Galvanic response	Faradic response
Normal	Nerve or muscle	Brisk muscle contraction on closing circuit	Muscle remains contracted while current flows
Partial reaction of degeneration	Nerve	Muscle contracts only with strong current	Muscle contracts only with strong current
	Muscle	Muscle contracts sluggishly	
Full reaction of degeneration	Nerve	No muscle contraction	No contraction
	Muscle	Muscle contracts sluggishly	
Absolute reaction of degeneration	Nerve or muscle	No contraction	No contraction

# Prospecting for Uranium Ore Using G-M Counters

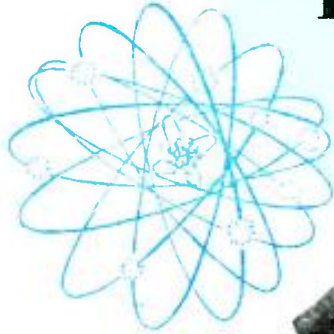

(Atomic Energy Commission Photo)

Data on radiation counters used in field prospecting

By SAMUEL FREEDMAN\*

Testing a sample of Allanite for radioactivity. Meter is Victoreen model 263. Radiation causes needle to move so fast that it is invisible.

**D**URING the past year the Atomic Energy Commission, aided by federal legislation, has started a program to stimulate the production of uranium by private individuals and organizations. To interest prospectors and producers a number of inducements are being offered. A \$10,000 bonus, for example, is offered for the discovery of any new uranium deposit that yields 20 tons or more of uranium ore or mechanically produced concentrates assaying 20% or more uranium oxide. The Commission also guarantees a 10-year minimum price of \$3.50 a pound for small lots of domestic refined uranium and the same price less refining costs for small lots of ore or concentrates assaying at least 10% uranium oxide, both prices f.o.b. shipping point. There are also guaranteed three-year minimum prices for the low-grade uranium-vanadium ores of the Colorado Plateau area. As an additional incentive, prospectors have been given the right to stake mining claims on land in the public domain.

Obviously, it is now profitable to prospect for uranium. And this is one type of prospecting likely to interest the electronics technician because the best way to detect uranium deposits is

to test for radioactivity with a Geiger-Muller counter or similar apparatus. Almost anyone familiar with schematic radio diagrams can build a suitable detector, or an instrument can be purchased. The Atomic Energy Commission can supply a list of known manufacturers.

**Encouragingly, uranium is estimated to be about 1,000 times as plentiful as gold and about 100 times as plentiful as silver. It probably occurs more often than either lead or zinc. These figures do not tell the whole story, however, as any one discovery, to be profitable, must contain a fairly large concentration.**

In the past the Colorado Plateau has been the only area in the U.S. that actually has yielded uranium. It came from low-grade carnotite ore, primarily mined for vanadium, and was a by-product selling at only about 35 cents a pound. With the new \$3.50 rate, the uranium is now a prime product. The Atomic Energy Commission is accepting even low-grade ores, for which there has been no previous market. Ore containing 2% vanadium oxide and 0.2% uranium oxide produced 50 miles from a purchase deposit will be paid for on delivery at \$25.40 per ton.

Individuals can follow several courses

in looking for uranium deposits. They can study untouched areas of the Colorado plateau. The uranium-bearing phosphate and shale formations in various parts of the country may eventually yield large deposits. Oil- and gas-well holes can be analyzed for radioactivity—samples of core material from the well are measured with a G-M counter, or a detector can be lowered down the well hole. All kinds of mine dumps, mill tailings, smelter slag, and similar byproducts can be studied. River placer and beach sand deposits may well provide a field for uranium discovery by giving clues to deposit locations.

In the past, prospectors have located most of the deposits by outcroppings on the rims of mesas. To find deeply buried ore deposits back from the rims, these areas must be drilled, and the drilled-out material then examined. The U. S. Geological Survey is now mapping and drilling a large number of such places.

Even though uranium is greatly needed, only about 400 scientists and engineers are looking for uranium ore under government sponsorship. The Atomic Energy Commission is therefore depending largely on the individual prospector. The Commission is establishing ore-buying stations. In-

\*New Developments Engineer, DeMornay-Budd, Inc.

formation on marketing uranium ore may be obtained from the Manager, Raw Materials Operations, U.S. Atomic Energy Commission, 70 Columbus Ave., New York, N. Y. RADIO-ELECTRONICS will supply on request a list of places to send samples for free assay. The Commission is currently publishing a prospector's guide entitled *Prospecting For Uranium* to facilitate this work. It is available from the Government Printing Office, Washington, for 35 cents. In Canada, a similar publication being published by the Department of Mines and Resources is entitled *Prospector's Guide for Uranium and Thorium Minerals in Canada*.

**The Geiger-Muller tube**

The heart of the radiation detector is the Geiger-Muller tube. It consists of a thin wire, usually tungsten, centered axially in a metal or glass envelope, with either a cylindrical cathode surrounding it or with a metal coating on the inside of the envelope. The tube is filled with a gas.

Effectively the detector is a gas-filled diode with enough d.c. voltage applied between cathode and anode to bring it almost, but not quite, to the firing point. When the voltage is critical, a single particle striking the tube from a radioactive source causes the gas to ionize. The tube then breaks down or fires and conducts heavily.

The remainder of the circuit in the instrument does two principal things. It makes the breakdown appear as a click in a set of headphones. Since a gas tube will continue to conduct until the voltage across it is lowered, the circuit also quenches the G-M tube by lowering its voltage immediately after each click.

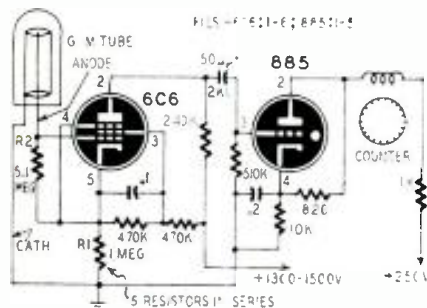

Fig. 1—A typical radiation counter circuit.

A typical radiation counter appears in Fig. 1. The 6C6 has an unbiased grid; so its internal resistance is very low. Most of the 1,300-1,500-volt applied potential (800 volts) appearing across R1 is applied through R2 to the anode of the G-M tube, which normally does not conduct.

When a radioactive particle hits the gas in the G-M tube, the tube fires, conducting heavily. Its current flows through R2 to ground, making the grid end of R2 negative. This blocks the 6C6. Since the 6C6 is now a high resistance, most of the high voltage appears across it, rather than across R1. The voltage applied to the G-M tube is

therefore very low, and it is quenched—stops conducting.

When it stops conducting, the negative voltage no longer appears between the 6C6 grid and cathode; the circuit returns to its former condition—about 800 volts across R1, 6C6 grid unbiased; and the G-M tube is ready for the next count.

Each pulse of current through the 6C6 makes the 885 conduct momentarily and operate the counter. In many instruments the pulses are registered as clicks in headphones. The pulses can be repeated at rates as high as 600 per minute. Faster counting is possible with special scaling circuits in which the counter registers once for each 2, 4, 8, 32, 64, 128, 256, 512, 1,024, 2,048, or 4,096 actual counts. These scaling instruments are fairly bulky and are for this reason ordinarily used only in laboratories.

The number of counts per minute depends on the number of radioactive particles striking the G-M tube. This, in turn, depends on the strength of the radioactivity in the vicinity, the quantity which the instrument is intended to measure. Counters of ordinary sensitivity will register some counts even when there is no concentrated radioactivity. Known as the background count, these indications are due to cosmic rays and other very weak sources of radiation which exist all around us. The dial of a watch with luminous numerals, for instance, will readily send up the counting rate on almost any radiation detector despite the small radioactivity of the luminous paint.

**Typical counters**

The Geiger-Muller counter was almost exclusively a laboratory instrument before the war. With the development of atomic energy, however, counters have come on the market in greatly increasing numbers. Units are available today at prices between \$70 and \$390. The instruments described here were selected for simplicity, low price, and good operation.

Fig. 2 is a schematic of Model SP-100 made by Victoreen Instrument Co., Cleveland, Ohio. As the photograph shows, an extension probe is provided. This instrument registers counts as clicks in a pair of headphones. It is entirely portable despite the high voltage required; the 900 volts is supplied by three 300-volt Eveready N. 493 batteries. The self-quenching circuit detects gamma rays.

The G-M tube is a type 1B87, 3/8 inch in diameter and 1 3/8 inches long. It fits in the probe, which may be brought close to radiating objects.

Victoreen's Model 263A is sensitive to both beta and gamma rays. A simplified schematic is given in Fig. 3 (no parts values were available), and a photograph is shown. The G-M tube is in a metal shield which has a slide for covering or exposing a screened section. When this screened section is covered, only gamma rays are recorded. When it is open, both gamma and

beta rays are received. Both meter and headphone indications are provided.

**The Cutie Pie**

Some radiation detectors do not use Geiger-Muller tubes, but employ instead an ionization chamber. The basic instrument is the war-developed "Cutie Pie," described in publication MDDC-997, available from the Atomic Energy Commission, Document Sales Agency, Oak Ridge, Tenn., for 10 cents.

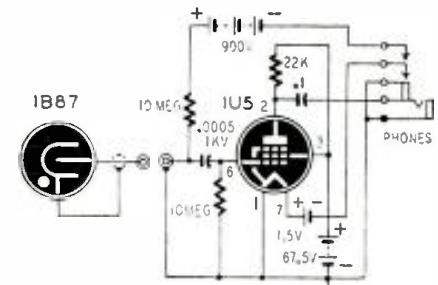

Fig. 2—Schematic of Victoreen SP-100 counter.



SP-100 counter with extension G-M-tube probe.

An ionization chamber is a cylindrical enclosure filled with an inert gas. When bombarded by radioactive rays or particles, the gas ionizes—separates into electrons and positive ions. The amount of ionization depends on the strength of the radiations.

Fig. 4 is a schematic of the type SU-1 radiation meter made by Tracerlab, Cambridge, Mass. Battery voltage is applied to the ionization chamber

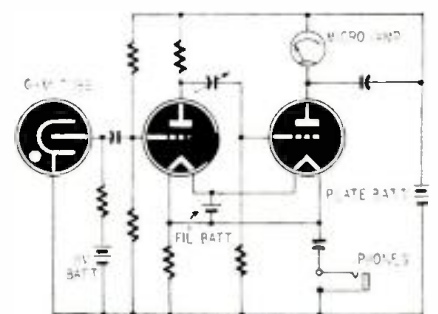

Fig. 3—Simplified diagram of Victoreen 263A.

# I. F. Amplifier in Miniature

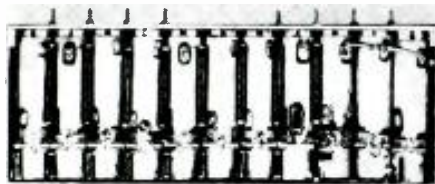

Fig. 1—I.F. strip is just  $6\frac{3}{8}$  inches long.

IF IT is true that good things come in small packages, the latest high-gain, broadband i.f.-amplifier strip developed at the National Bureau of Standards must be one of the best. The strip contains eight stagger-tuned i.f. stages, a detector, video amplifier, and cathode-follower output circuit, has over 95-db gain, manual and automatic gain controls, and a 10-mc bandwidth; yet it is only  $6\frac{3}{8}$  inches long, 2 inches wide, and  $\frac{1}{16}$  inch thick!

The incredibly small size is made possible by subminiature tubes, printed circuits, and ingenious assembly methods. The development of this i.f. strip

is part of a program sponsored by the Navy's Bureau of Aeronautics to subminiaturize complex radio assemblies for aircraft and for missiles. And an important aim of the program—already achieved in tests with the i.f. strip—is to design the equipment so that, despite its small size, it is readily adaptable to factory production-line techniques.

The photograph of the subminiature i.f. strip (Fig. 1) gives some idea of its compactness. Fig. 2 shows a complete i.f. stage held between a man's two fingers.

The cutaway drawing of the i.f. stage

in Fig. 3 illustrates the unconventional printed circuits used. The tube is a subminiature, similar to the now common hearing-aid types. Since the Bureau defines a subminiature assembly as one whose minimum size is limited mainly by available tubes, this component is naturally of primary importance.

A cylinder made of a high-dielectric-constant ceramic is just large enough to slip over the tube. Most of the resistors, capacitors, and circuit connections are printed on the outside of the ceramic cylinder. The inside of the cylinder is metallized, serving both as a ground plate for the capacitors printed on the outside and as a shield for the tube. Over the printing on the outside of the cylinder is a high-temperature insulation and over this a metallized shield coating.

This apparently simple scheme results in a complete electronic circuit including amplification, resistance, ca-

## PROSPECTING FOR URANIUM ORE

(Continued from previous page)

through one of three high-value resistors. When radiations strike the chamber, electrons flow from its co-axial center conductor through the ionized gas to the aquadag-coated inner wall of the cylinder. The very small current is enough to produce a usable voltage drop across whichever of the high-value resistors R1, R2, or R3 is switched in. The drop is applied to the grid of a sensitive, balanced vacuum-tube voltmeter. The meter indicates the intensity of the radiation, since the current flow through the chamber is proportional to the degree of ionization,

which, in turn, depends on the radiation strength.

This complete instrument weighs only about five pounds. Eight small batteries within the case supply power. Another ionization-chamber instrument, Model 401-X, made by Atomic Instrument Co., Boston, Mass., is also shown.

Although ionization chambers are used extensively in many applications, Geiger-Muller tubes are about 100 times more sensitive. G-M tubes are also about 100 times more sensitive to beta than to gamma radiation.



(Photo courtesy Atomic Instrument Co.) Ionization-chamber type of meter (Mod.401X).

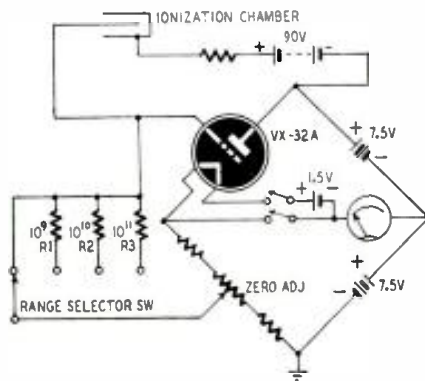

Fig. 4—Circuit of Tracerlab SU-1 ionization-chamber meter. This is similar to "Cutie Pie."

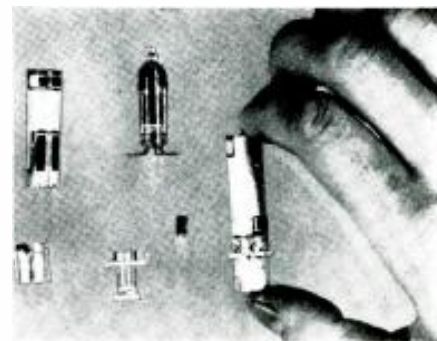

Fig. 2—Single stage is diameter of a finger.

pacitance, and connections in an assembly only a shade thicker—and no taller—than the vacuum tube itself.

A small amount of added space is needed, of course, for the tuning inductor. This is a bifilar winding on a ceramic form attached to the bottom of the ceramic cylinder. As the photograph (Fig. 2) and the drawing (Fig. 3) show, the coil form is less than half the size of the tube-cylinder part of the assembly and adds very little bulk to it. A powdered-iron core is adjusted

with a screw in the base to tune the circuit.

Constructing a complex electronic circuit in such a small space is achievement enough, but the job of the Bureau of Standards is not to develop interesting toys. To be of practical use, the i.f. strip must be available in large quantities and must be made by ordinary workers on a production line. Far from stopping at the design stage, the Bureau's experts have developed procedures and equipment for large-scale production, even to the extent of setting up a sample production line (Fig. 4). Here ordinary workers, not engi-

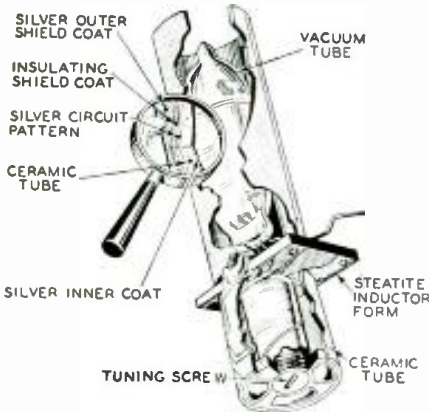

Fig. 3—A cutaway drawing of the i.f. stage.



Fig. 4—Pilot production line tests methods.

neers, turn out i.f. strips in imitation of factory methods while Bureau experts analyze each stage of manufacture and change an operation here and a procedure there to speed assembly and improve product quality.

While printed circuitry on flat surfaces is very nearly a commonplace today, despite the short time since the first printed-circuit developments, printing capacitors, resistors, and connections on *cylindrical* surfaces is something new.

Two methods are being used in the experiments. One, shown in Fig. 5, is an inverted rotary press which prints directly on the ceramic cylinders. Though the one pictured is a small experimental unit, high-capacity equipment for large-scale production has been designed and built.



Fig. 5—A specially adapted, inverted rotary press is used to print circuits on cylinders.

Another method makes use of conductive decalcomanias which are applied to the cylinder's surface. The decals may be applied by hand or such standard machinery as bottle-labeling machines (slightly modified) can be used.

The advantages of subminiaturization are important. Today's engineers are surpassing their predecessors' wildest dreams of electronic achievement. Entirely aside from broadcasting and communications, electronics is helping man to compute, navigate, produce, and—unfortunately—to make war in more deadly and efficient ways, with guided missiles and explosives that "know" when to explode.

The equipment is necessarily more elaborate. It is more *complex* because the variety of circuits is wider; it is more *compound* because the number of pieces of equipment is greater. If something did not give way, man might become an insect in a world of gigantic pieces of apparatus.

What does give way in the course of evolution is the size of the components. This is as necessary as any other form of evolution. It keeps man the master of his tools rather than drowning him in their flood. As the complexity of the electronic servant grows, more and more of him will be crammed into the same space.

The end is not in sight.

### COSINE MEMORY AID

**S**TUDENTS of electronic theory meet on every hand problems involving trigonometric functions, particularly that of the cosine in power-factor calculations.

The calculator often wishes to make a quick estimate in a computation. A simple memory aid to obtain surprisingly accurate "trig" functions will be helpful.

Rather than trying to remember the odd values of the cosine directly from tables, it is easier to memorize this series of numbers: 2, 4, 8, 10, 12, 14, 16, 17, 17. Notice that the numbers all increase by steps of 2, except for the 8, and that the last two numbers are out of step with the rest of the series.

In application, these memorized numbers are subtracted as follows:

- cos 0° = 1.00
- cos 10° = 0.98 (subtract: 100—2)
- cos 20° = 0.94 (98—4)

- cos 30° = 0.86 (94—8)
- cos 40° = 0.76 (86—10)
- cos 50° = 0.64 (76—12)
- cos 60° = 0.50 (64—14)
- cos 70° = 0.34 (50—16)
- cos 80° = 0.17 (34—17)
- cos 90° = 0.00 (17—17)

Note that these values are accurate to at least 2%. Of course, values for intermediate functions can be obtained by interpolating between two of the values shown. Thus,

$$\cos 28^\circ = 0.94 - \frac{8}{10} (.94 - .86) = 0.88.$$

which compares extremely well with the value of 0.8829 given in tables.

Then, of course, sines of angles can be obtained by knowing that:

- sin 90° = cos 0°
- sin 80° = cos 10°
- sin 70° = cos 20°

and so on.—Edward A. Bogusz

# Design Your Own Crossover Network

**Dividing networks channel bass to the woofer and treble to the tweeter. Rolling your own is easy**

By **JAMES R. LANGHAM**

**A**LL the following took place when we had just recently graduated to a 15-inch speaker. We had squeezed out enough money to buy a high-frequency driver. I had finished tin-snipping and soldering some old gasoline cans into a horn cluster enough before to have my hands heal.

"Hey, engineer," the XYL called out. "When are you going to get this super speaker system playing?"

"Have to wind a new field coil for that high-frequency driver," I said. "We can't use a 6-volt field."

"Have you designed the crossover network yet?" she wanted to know.

I shook my head. "I have to wind the field coil first."

She picked up the spool of No. 30 wire. "Okay. I'll wind the field coil while you make with the slide rule. What impedance you want?"

I shrugged. "Wind it as full as it'll go. It's not too critical."

She nodded and departed for the technical school to wind the coil. I opened books reluctantly. I had been stalling because of a secret fear of this crossover-network designing. All sorts of esoteric things like *m* and *j*, and phase differences, and such. Terman's book made it sound very difficult, and so did all the other books; I would really have to dig in. It *was* difficult, and partly because there was a lot more in the books than there had to be. Now, as I look

steepness of the cutoff as well as the resistive and reactive components of the complex impedance and . . . but what was *m*?

Well, I asked many smart men that question, without once getting an answer. Not a real answer. They begin by explaining it's a factor in the impedance relationships; and I retort, "I know that, but what does the *m* mean? Why not *n* or *v* or something else?" They sigh then, and begin wandering off into the semantics of abstraction. If I try to pin them down, they just get sulky and think I'm being stupid and uncooperative.

and imaginary parts. The proper procedure . . . is to take the value of *M* as it comes and substitute it . . . whenever *M* appears . . ."

Such concepts are not uncommon in electronics, though they are unnecessarily complex for the non-engineer.—*Editor*)

Crossover networks themselves are divided into two main classes, the *m*-derived and the *constant-Z*. Both of these are further divided into series and parallel types. Most of the commercial circuits, those used in broadcast studios, are *m*-derived. They provide sharper cutoffs and, in general, are preferred.

The *constant-Z* circuits have no *m* business in them, and their attenuation curves slope more gradually. They are satisfactory in most cases, however.

Now, the slope of attenuation must not be too steep. If it is, you'll get distortion and peculiar sounds from the speaker. If the curve is too gradual, you are conscious of the sound coming from two sources and that is annoying to the listeners. Experiments show that best listening comes when there's at least 10 db of attenuation an octave away from the cutoff frequency *f<sub>c</sub>*. At the other extreme, a slope of 18 db per octave should not be exceeded. It won't listen so good.

Fig. 1 shows the series and parallel *m*-derived circuits and the design formula. Notice there is no foolishness with *m*. I just substitute 0.6 for *m*, the value thought correct by most authorities. This makes it simpler, and I wish I could have seen it this way when I first tried to design the gimmick. *Z* is the impedance of each voice coil and of the amplifier output.

Of these two, I have usually picked the parallel type because less capacitance is needed. The capacitors are bulky because we are dealing with low-impedance lines and must use low values of reactance. They must be paper capacitors—*don't try to use electrolytics here*—and they can be made up from a stockpile of smaller units. Stack up a series of 0.5's or 1.0's if you can't get the larger ones.

Fig. 2 shows the characteristic of these crossover networks and, for those interested in their exact impedances, the resistive and reactive components are presented in Figs. 3 and 4. The modulus or absolute values at any frequency are found by this simple equation:  $Z = \sqrt{R^2 + X^2}$ .

As you can easily see from the plotted curves, the actual impedance does wan-

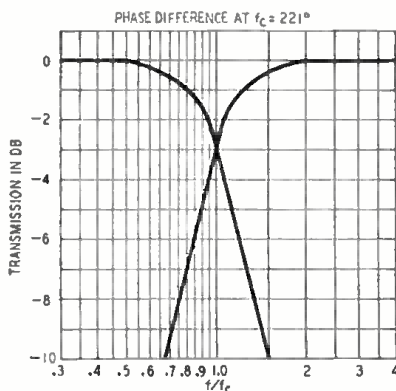

Fig. 2—Combined characteristic of *m* network.

After asking maybe a hundred or so engineers and physicists about this *m* business. I have finally come to the same conclusion that I came to that afternoon when the XYL left me with the design job. The *m* is just a number which is used in computing the circuit constants.

For crossover networks, just substitute 0.6 wherever you see *m*, and you'll come out all right.

(In a section of his *Radio Engineers' Handbook* devoted to systems in which coupling varies with frequency [page 166] Terman says:

"The quantity *M* . . . represents the effective coupling . . . between primary and secondary circuits. It is not necessarily a real mutual inductance of the inductive type but rather a sort of mathematical fiction that gives the equivalent effect of whatever coupling is present. If the coupling is capacitive . . . *M* will be . . . negative; if the coupling is of a complex type representing both resistive and reactive coupling . . . *M* will . . . have both real

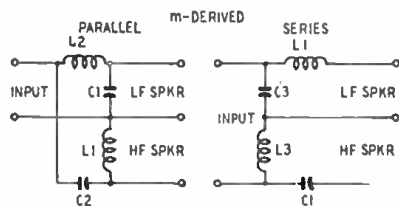

$$L1 = \frac{Z}{6.28f_c} \text{ henries}$$

$$C1 = \frac{10^6}{6.28f_c Z} \mu\text{F}$$

$$L2 = 1.6 \frac{Z}{6.28f_c} \text{ henries}$$

$$C2 = \frac{1}{1.6} \times \frac{10^6}{6.28f_c Z} \mu\text{F}$$

$$L3 = \frac{1}{1.6} \times \frac{Z}{6.28f_c} \text{ henries}$$

$$C3 = 1.6 \frac{10^6}{6.28f_c Z} \mu\text{F}$$

NOTE—*f<sub>c</sub>* = Crossover Frequency

Fig. 1—Design data for *m*-derived crossovers.

back, I wonder why all the fussing. It's really easy to design a crossover.

The main thing that threw me was that *m* business. What *did* *m* stand for? It was plain that *m* was an important factor, and the various equations showed that varying *m* varied the



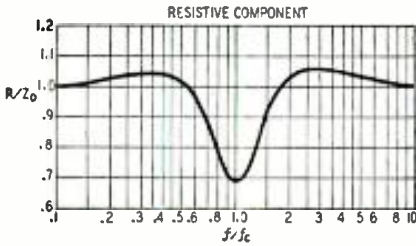

Fig. 3—Variation of the resistive component.

der around a bit. This will not bother you in 99% of all cases. The times when it will be a bother are those when you have a lot of feedback and a ticklish phase relation in your amplifier. Then you may get some oscillation.

The constant-Z circuits do not give trouble that way. They are shown in Fig. 5, and their attenuation characteristic is plotted in Fig. 6. The series type makes for smaller capacitors, which again must be low-loss—no electrolytics. I did hear once about a chap who used electrolytics successfully in a crossover network by putting a small bias voltage across each one to keep them formed up; but I don't know how successful it was, and it seems like a lot of trouble.

Now that you see how to design these affairs, there are some words of warning: pick your crossover frequency with care.

The speaker systems used in theaters have crossovers in the neighborhood of 250 cycles. The commercial boom-box

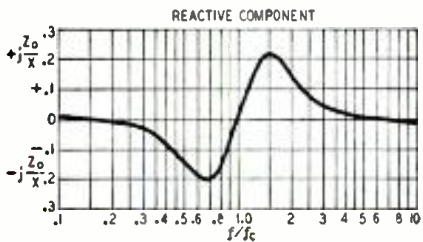

Fig. 4—Reactive component in m-derived net.

and horn-cluster speakers (like the Lansing and Jensen) generally have a crossover frequency at 500 cycles or even higher. The co-axial speakers have a crossover anywhere from 1,000 cycles up to 2 kc or higher.

Now this is important. What with horn lengths and capacitor and coil sizes, you will be tempted to make your crossover frequency too high. This will mean more sound will come from the

cone speaker and less from the horn (or other tweeter). The sound from the cone speaker is appreciably poorer in quality, with bumps and hollows as well as distortion due to driving the cone too far with consequent breakup into harmonics. That's one consideration, but it isn't the main one.

Divided presence is the main reason. Divided presence is the term used to mean you'll hear the sound from two sources and be annoyed by it. Now, you may think this doesn't amount to anything, but it really can be awfully annoying. It happens when you are too close to the twin speakers or the speakers are too far apart physically.

If a speaker system could be made up that extended over a whole wall and

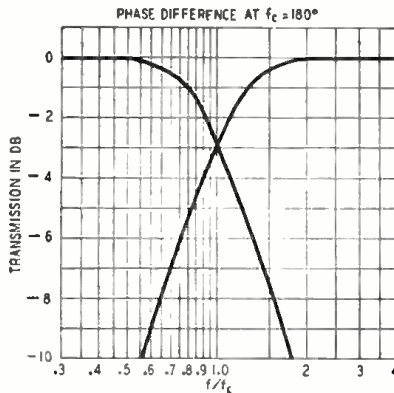

Fig. 6—Attenuation of a constant-Z network.

had each speaker put out sound from just certain small groups of instruments, it would be fine. But we can't do that. Instead we are having all the sound come from two speakers and are dividing it arbitrarily by pitch. When an instrument goes from low to higher register, it can be mighty unpleasant to hear the shift between speakers.

With co-axial speakers this is not important because both speakers originate the sound in about the same place and they can get away with a high crossover.

So squeeze your speakers as close together as possible and pitch your crossover as low as you can with the horns you have available. The horn size limits the lowering of your crossover frequency: the smaller the horn, the higher its low-frequency cutoff.

If you don't know where your horn cuts off, run a curve on it; but don't pump too much level into the horn. Below the cutoff frequency of the horn there's practically no load on the diaphragm of the driver, and it is easily damaged by trying to make it squirt out sound without a proper load. Run a low-level curve and determine your cutoff; then pitch your crossover accordingly.

For those of you who plan on making your own horns, spend an extra buck and make the horns for a lower frequency to give yourself some leeway. I really consider the commercial horns too small and the crossovers too high for convenient listening in the home. You can't get far enough away from the speakers. Making larger horns is a little more work, and you may damage yourself a bit more in cutting and soldering; but the extra work and cost are well worth the results.

Now to finish up, let's design a crossover. Let's say we make it 400 cycles with speaker impedances of 16 ohms. Let's pick a parallel m-derived circuit (Fig. 1) and walk through it.

$$L1 = \frac{16}{6.28 \times 400} = .00637 \text{ h or } 6.37 \text{ mh};$$

$$L2 = 1.6 \times .00637 = 10.19 \text{ mh};$$

$$C1 = \frac{10^6}{6.28 \times 400 \times 16} = 24.9 \text{ } \mu\text{f};$$

$$C2 = \frac{1}{1.6} \times 24.9 = 15.56 \text{ } \mu\text{f}.$$

The coils should be air-wound somewhere close to 3 inches in diameter. Don't use too small wire; remember you've got current here with these low impedances. Mount the coils at right angles to each other. Take both coils and capacitors over to a lab or technical school if you can, where you can check them on a bridge before you make your installation. You can take off turns and add small paper capacitors while you watch (or listen to) the balance.

Don't tape the coils with transparent cellulose tape if you live in a damp climate.

As I say, I wish I could have known all this when I worked out my first crossover network.

## WIRE RECORDER IS MODERN PIED PIPER

PROVIDING a modern sequel to the famous story of the Pied Piper of Hamelin, a magnetic wire recorder was used recently to lure rats to their doom. The story is told in a letter written by James G. Anderson of Vancouver, British Columbia, to W. S. Hartford, general sales manager of Webster-Chicago Corp.

Mr. Anderson's problem was a warehouse infested with rats. Acting on the premise that rats are cowards, he first caught a couple of the rodents in a cage. Then, poking and prodding them until they squealed with fear, he picked

up their cries with a microphone and recorded them on wire.

When the rat cries were played back in the warehouse through a PA system, there was a veritable stampede of rats making for every exit they could find!

As a variation on the technique, Anderson caught a single female rat and recorded her cries. Apparently the sex instinct is as strong in rats as in other creatures, for, as the lady rat's cries were broadcast through the building by the PA system, gentlemen rats came running from every direction to be executed with a special pistol.

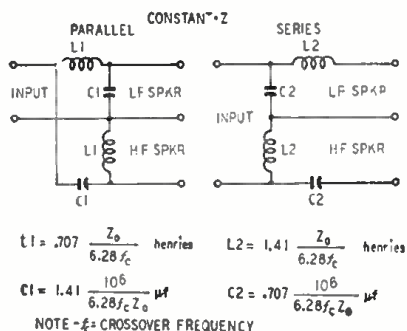

Fig. 5.—The constant-Z formulas and diagrams.

JULY, 1949



# Radio Set and Service Review

**Motorola 68F11, 68F12, and 68F14**

**L**IFE for most people, including the radio service technician, is made up largely of the commonplace. While some sets coming in for repair may have unusual faults or may contain special circuitry, the great majority of work is done on standard, usually small, a.c.-d.c. radios and radio-phonographs.

Motorola's HS-124 chassis is one of these. It is to be found in models 68F11, 68F14, 68F14M, 68F14B, and 68F12. The model shown in the photographs, the one we had for examination, is a 68F11, a plastic-cabinet table model. The 68F12 is the same in a wood enclosure, and the others are similar but furnished in a high cabinet with record-storage space beneath the radio-phonograph proper.

Performance and operation were tested by simply tuning the receiver, listening to records, and watching the changer work. The results were, in every respect, approximately what might be expected of an instrument of this type. Sound was clean at fairly low to medium volume levels, the receiver was sensitive enough to pick up most New York stations in a downtown non-steel building, and the record changer appeared to have no tendency to damage the discs used in the test. The changer has the customary stationary center post, which tends to enlarge record center holes, but this is apparently unavoidable in almost any but rather expensive machines. As the cabinet photo shows, a single outer post is used; adjustment for the two record sizes is merely a matter of rotating this half a turn.

Though there are actually seven controls on the set, they are all closely grouped on the front panel. The knob at left is the on-off-volume control, and that at the right tunes the receiver. The center device is a four-part switch, each quarter of the circular knob assembly performing a separate task. Reading counterclockwise from the up-

per left, there are PHONO, REJECT, MOTOR, and TONE controls.

Except for the REJECT portion, which is a momentary-contact switch, all of these are latching devices—push once to turn on (button stays in), and push again to turn off (button comes out). With the chassis out of the cabinet, they all worked well; but, assembled, switch action was sometimes mushy, and often a switch would not stay in when it should have. This appeared to be due to the rather tight fit where the

switch assembly goes through its panel hole. Loosening the chassis-cabinet screws and repositioning the chassis slightly so that no switch knob touched the hole fixed the trouble.

The chassis photograph indicates how the height of the instrument is kept low despite the use of a standard five-tube (and rectifier) superhet circuit. Four of the tubes and the rectifier are mounted on the rear apron; the tuning capacitor and the 6C4 oscillator tube are on the side. Only the speaker and

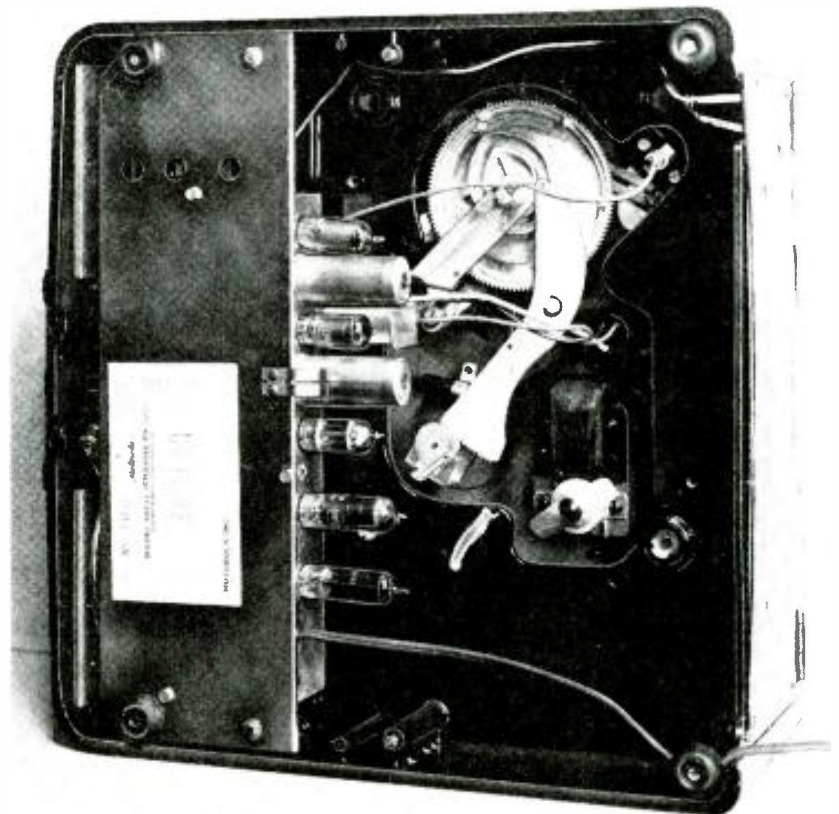

Underneath the radio-phonograph with the metal tube cover removed. Notice miniature tubes.

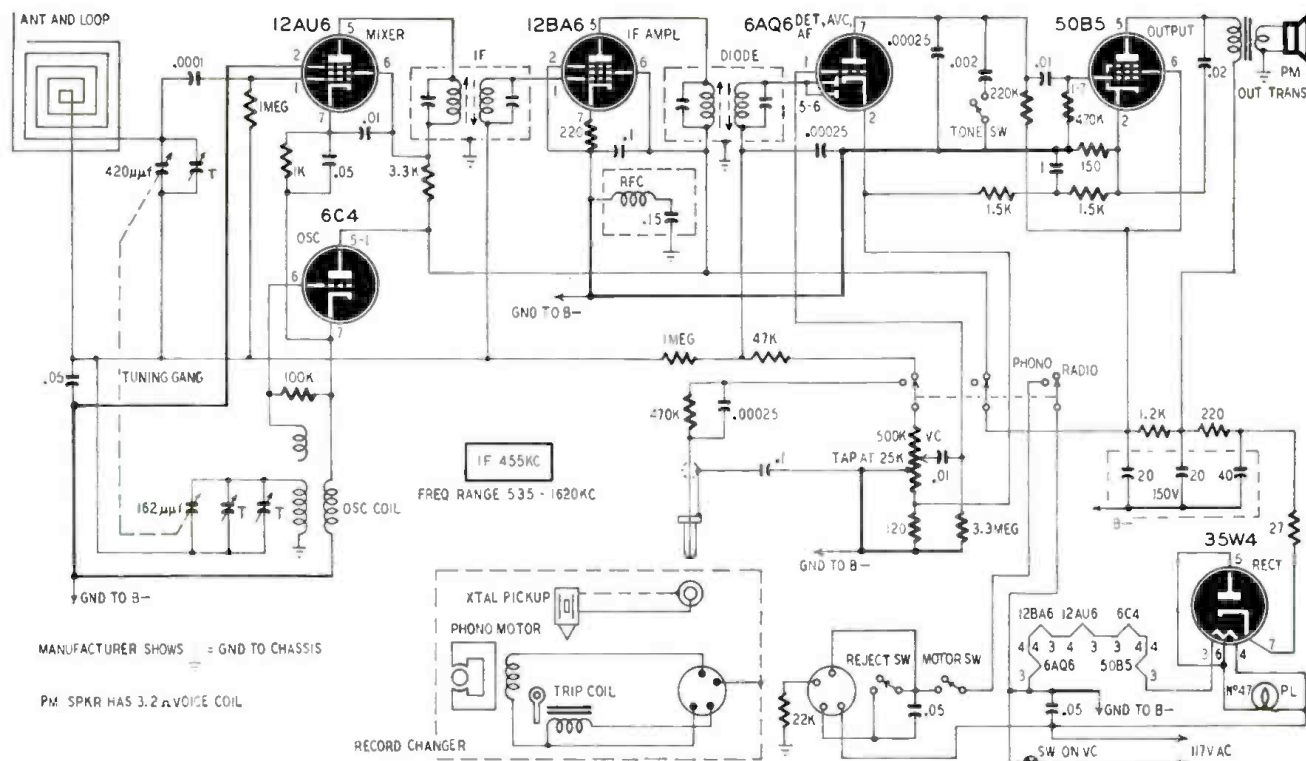

Circuit diagram of the Motorola HS-124 chassis. Note the use of a separate oscillator tube. Chassis is otherwise standard 5-tube superhet.

the tuning-indicator assembly project upward; these are on the front of the chassis where the bottom of the player-section floor curves upward to accommodate them. The undercabinet photo

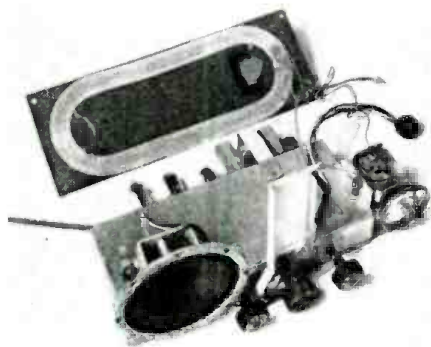

The chassis is easily removed for servicing.

shows the chassis in its place; a metal strip ordinarily covers the tubes.

The diagram indicates that the circuit is not unusual except in one or two respects. One interesting feature is the synthetic bass circuit R9, R12, R13, and C12. A small speaker cannot reproduce bass notes adequately; but if the ear is supplied with harmonics of the low tones, it transmits sensations to the brain much like those caused by genuine bass. The circuit was described in the October, 1948, issue of RADIO-ELECTRONICS on page 37.

Another variation from the norm is the use of a separate oscillator tube (a 6C4) with a 12AU6 as mixer. Ordinarily, a single pentagrid tube is employed for both functions. Oscillator-mixer coupling takes place between the cathodes, effectively tied together.

The loop antenna is placed on one

surface of a piece of fairly light-weight cardboard, which can be damaged without too much difficulty. The external antenna lead is taped to the outside.

The crystal pickup has a special metal-tipped stylus which can be removed with long-nose pliers. Ordinary needles will not work, and a replacement must be secured from Motorola.

During alignment, the a.f. output of the receiver should be kept at about 0.4 volt for greatest accuracy. The i.f.'s are set up in the usual way.

To take care of the r.f. circuits, connect the generator to pin 1 of the 12AU6, set frequency at 1620 kc, and adjust the trimmer screw beneath the front section of the tuning capacitor for maximum output. Then set the generator to 1400 kc and couple the signal to the set through a 5-inch-diameter, three-turn loop. Adjust the rear-section capacitor trimmer for maximum. The last step should be repeated after the chassis is replaced in the cabinet for best accuracy.

"LIVE" DIAGRAM DEMONSTRATES TELEVISION CIRCUITS

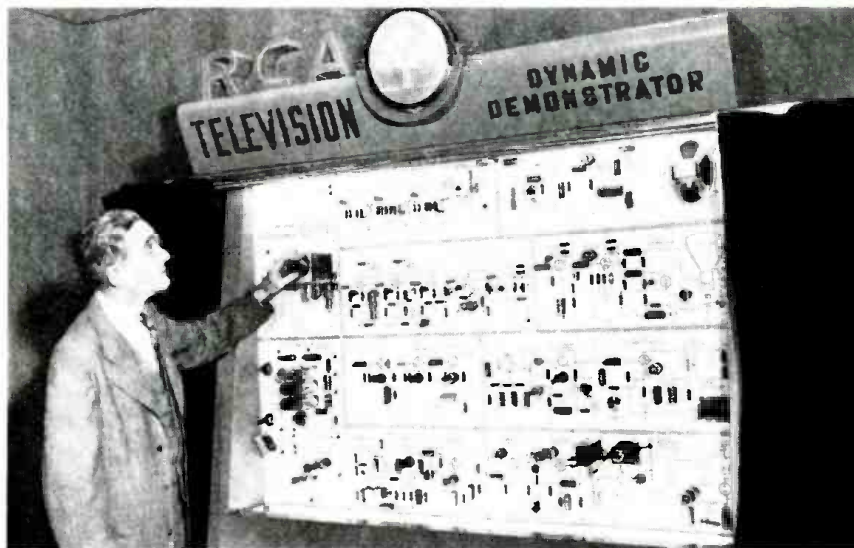

To show technicians and students how a TV receiver works, John Meagher of the RCA Tube Department designed the Television Dynamic Demonstrator shown above. The big board displays a giant schematic of a 30-tube set with an actual component fastened to the board wherever a schematic one is shown, and wired into the circuit to form a real television receiver. The demonstrator has 200 plug-in parts which can be removed or changed to show the effect on performance. The circuit—schematic and actual—is divided into 10 sections.

# Fundamentals of Radio Servicing

## Part V—How capacitors are made

By JOHN T. FRYE

**A** CAPACITOR, we learned in the last chapter, is a device for storing an electrical charge; and the amount of charge stored depends upon the voltage applied and the capacitance of the capacitor. We found that capacitance was related to the active area of the capacitor plates, the spacing between those plates, and the K of the dielectric employed. Two desirable features in a capacitor are low leakage current and high breakdown voltage. Now let us see how all these factors enter into the construction of actual capacitors used in radio work:

There are more ways of designating capacitors than there are of describing pretty girls, but one of the most common methods is to refer to the dielectric material; so let us begin with *air* capacitors—those with only air between their plates.

The simple capacitor discussed in the previous chapter used only two plates, but you can see from the picture that most air capacitors use several. The plates are divided into two sets, with all the plates of each set connected together, and with the plates of one set interleaved with the plates of the other, as shown in Fig. 1. This is to economize on space. You will recall that in a charged capacitor the electrons are crowded onto that portion of the nega-

tive plate facing the positive plate. That means that in a simple capacitor only one surface of the plate is used for electron storage.

However, as can be seen in Fig. 1, when the plates are interleaved, each surface of each negative plate is charged with electrons when it is between two positive plates, and the result is the same as doubling the size of the plates in a two-plate capacitor. It is just like buttering your bread on both sides!

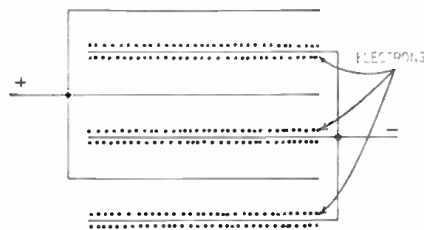

Fig. 1—Interleaved plates of variable unit.

By arranging our capacitor so that we can control the degree of interleaving of the plates, we can produce a variable capacitor similar to most air-spaced units used in radio work. Very stable as to capacitance, they have almost zero leakage current. They are bulky, though, and it is difficult to build very much capacitance into a reason-

able space. You seldom see air capacitors of more than 500  $\mu\text{f}$ . The main trouble that develops in these capacitors is warping or bending of the plates so that they touch and short out. Occasionally sufficient dust gets between the plates to form a low-resistance path. In a variable capacitor, one set of plates (the rotors) must move, and a sliding wiper contact is used to make an electrical connection to this set. Sometimes dirt or corrosion causes this contact to become erratic.

A capacitor of considerably greater capacitance can be built in the same space by using thin sheets of mica as the dielectric and by employing much thinner metal plates. These *mica* capacitors as they are called, are enclosed in a case of bakelite or similar material for mechanical protection and to keep out moisture.

Since mica has a higher K than air, mica capacitors are more compact than air capacitors. Their leakage is nearly as low; and, by using thicker sheets of mica, the breakdown voltage can be made very high. You will find them in ranges from about 100 to several thousand volts, and from 10  $\mu\text{f}$  to about 0.1  $\mu\text{f}$ . However, they are comparatively expensive; and as breakdown voltage and capacitance increase, they become quite bulky. A very stable type of mica capacitor, the *silver mica*, is made by using silver plating directly on the mica sheets instead of metal plates.

Mica capacitors do not give much trouble, but they do give some. In fact, like an "angel child," micas develop faults just often enough to waste a lot of your time checking everything else before your suspicion finally falls on them. Occasionally they break down and short out, or the wire lead connecting to a set of plates makes a poor contact and causes an open. More rarely, moisture may get in and cause a high leakage current.

*Paper* capacitors are the workhorses of radio; they really carry the load. Even an a.c.-d.c. midget has a dozen or so of them. They usually consist of two long, thin strips of aluminum foil, insulated by paper and rolled up in a tight little cylinder, with wire leads from each strip of foil being brought out of opposite ends. They are covered,

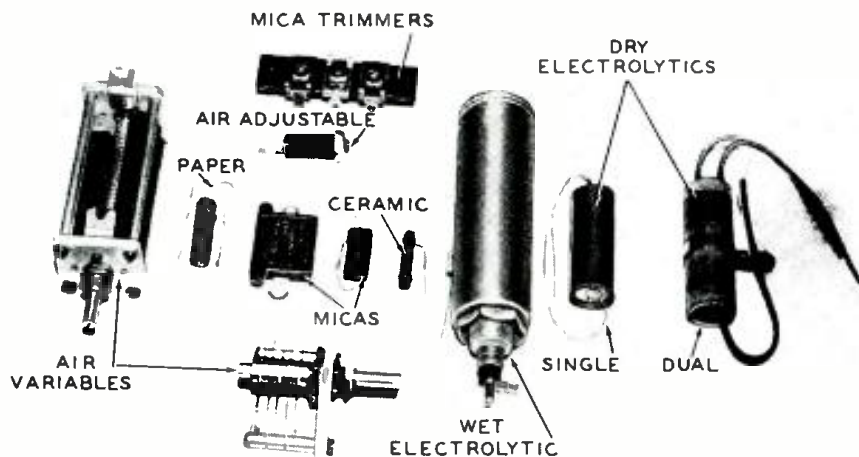

These are just a few of the many shapes a capacitor may take, depending on the application.

treated with oil, and sealed with wax against moisture.

Paper capacitors are ordinarily found in values from about .001 to several microfarads, and from 100 to 1,600 volts. They are more compact than micas and cheaper, but they have somewhat higher leakage currents and deteriorate with age because of the gradual penetration of moisture into the paper.

Immersing a paper capacitor in certain types of oil increases its breakdown voltage and also increases its life because the oil prevents the entrance of moisture. That is why much military equipment that had to be dependable used *oil-filled* capacitors instead of the ordinary paper kind. The smaller ones are sometimes called "bathtubs."

Thin plastic films have been used in place of the paper as a dielectric, and some of these plastic-film capacitors have electrical qualities superior even to mica units.

Paper capacitors have the same shorting and open troubles to which micas are occasionally prey, but they have them much more often. They are more likely to become leaky, too; and if they become too hot, the wax runs out of them and allows moisture to enter easily. Still they are by far the most often-used capacitors in radio because of low cost.

For securing the most capacitance in the least space for the smallest amount of money, *electrolytic* capacitors are the answer. These come in two kinds, wet and dry. Fig. 2 is a sketch of a wet

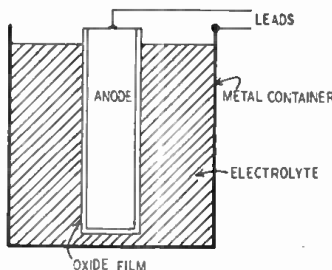

Fig. 2—Structure of a wet electrolytic unit.

electrolytic. It consists of an aluminum plate, called the anode, immersed in an electrolyte, such as a boric acid solution. The anode has on its surface a very thin oxide film that has been formed electrochemically prior to assembling the capacitor and putting it into its case.

Following the previous explanations, you might jump to the conclusion that the electrolyte is the dielectric, but that is not true. The dielectric is the thin oxide film—which incidentally has a K of about 10. The aluminum anode forms one plate of the capacitor, and the electrolyte forms the other; the metal container simply serves as a means of making contact with the electrolyte.

*Dry electrolytic*, like *dry cell*, is somewhat of a misnomer. *Damp* electrolytic would be better, for in such a capacitor the liquid electrolyte is replaced with a paste. What is more, the

anode is replaced with an oxide-coated strip of aluminum foil, and the container is replaced with an uncoated strip of foil called the cathode foil. These two strips of foil, with the electrolytic paste and a suitable mechanical separator between them, are rolled into a bundle in exactly the same way as are paper capacitors. The result is a convenient cylinder.

The capacitance depends on the surface area of the anode and on the nature and thickness of the film. To increase the surface area, the anode foil is frequently etched with acid, and the increased area of the "hills and valleys" thus produced on the foil sur-

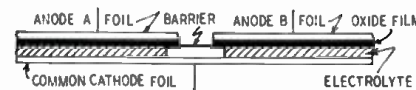

Fig. 3—Single container holds two capacitors.

face increases the capacitance of an *etched-foil* capacitor over that of a plain-foil unit by two to seven times. Another way of doing the same thing is to spray molten aluminum on a strip of cotton gauze to produce a gridlike anode that will give a capacitance 10 times that of a plain anode strip. These are called *fabricated-plate* electrolytic capacitors.

The thickness and nature of the oxide film are determined by the forming process. While a thinner film increases the capacitance, it also lowers the breakdown voltage. Electrolytics used in radio are found in capacitances of a couple to several hundred microfarads and in a voltage range of 6 to 600. By using more than one anode strip or more than one cathode strip, and by having barrier strips separating these units, it is possible to have more than one capacitor in a single container. Fig. 3 shows one such dual-unit arrangement.

Electrolytics are unlike other capacitors in that they ordinarily are *polarized*. This means that they must be used only with d.c. voltages and that the anode must always be connected to the positive point. If these rules are not followed, the oxide film will disintegrate and the capacitor will be destroyed.

An electrolytic capacitor is only as good as its oxide film, and various factors can injure this coating. A temporary surge of high voltage may puncture it; but if the voltage is quickly reduced, the film will usually heal itself. A reverse current through the capacitor, impurities in the materials used, long subjection to too high a voltage, and too many months spent lying unused on the shelf will usually result in permanent damage. Electrolytics are usually designed to operate between 32 and 140 degrees F, and they should not be subjected to temperatures far beyond these extremes for any great length of time.

If the film is broken down, the capacitor usually appears as a partial or complete short, and the leakage current

is excessive. If the electrolyte dries out or if one of the connecting leads becomes separated from its foil, the capacitor shows an open circuit. Sometimes, before complete evaporation of the electrolyte, the capacitor shows a marked loss of capacitance.

A comparatively new type of capacitor that is rapidly gaining in popularity is the *ceramic*. It consists of a tube of rutile ceramic with the inside and outside plated with silver. The two silver coatings are the capacitor plates, and the ceramic material is the dielectric—with a K of up to 170!

Ceramics, like Lana Turner, seem to have everything—small size, high capacitance, high voltage rating, and low power factor. What is more, by regulating the mixture of the ceramic material, the capacitor can be made to have a positive, zero, or negative temperature coefficient, which is another way of saying that the capacitance can be made to increase, stay the same, or decrease with a rise in temperature. This feature compensates for heat changes in other components of an electrical circuit. When the capacitance of these components "zigs" with an increase in temperature, you can employ a ceramic condenser that "zags" an equal amount, and *vice-versa*, and thus maintain the over-all capacitance constant.

The manufacturers did not develop all these different types just to show what they could do. Each type fills a particular need. The choice for a particular job depends upon which will do the work best for the least cost. In some spots the most important thing is lots of capacitance; so an electrolytic is used. At another point the capacitor must not change its value; so a silver-mica unit is employed. If the leakage must be extremely low, an ordinary mica serves nicely; and for run-of-the-mill applications, paper capacitors do the job. Air-spaced units are used for variable and semivariable duty because of obvious mechanical advantages.

Now that we have become thoroughly familiar with the strengths and weaknesses of the coil and the capacitor, it is high time that our hero and heroine meet; and that they will do in the next chapter. Don't miss this thrilling event, folks, "When Coil Meets Capacitor;" for that is how radio began!

Suggested by Harold T. Snow, Milwaukee, Wis.

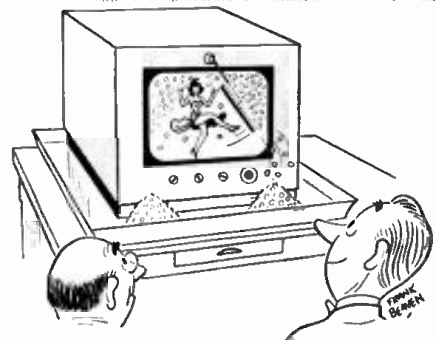

"Best 'snow' eliminator made."

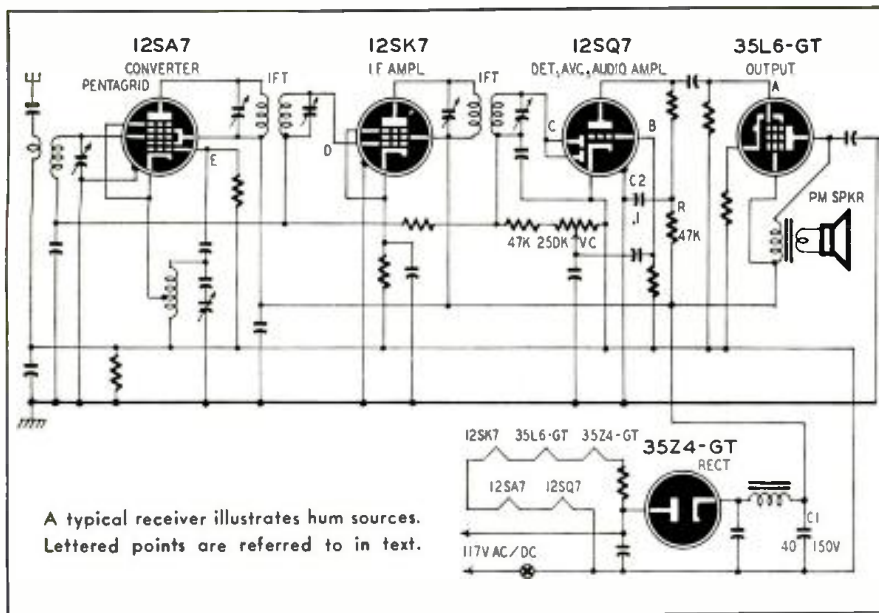

# Simple Routine Check Locates Receiver Hum

By J. T. CATALDO and S. J. RICHARD\*

LOCATING and eliminating hum in a radio receiver can be an irritating and difficult problem if no systematic method is employed. There is, however, a simple, routine check system which cannot fail to ferret out the evasive and aggravating 60- or 120-cycle disturbance so frequently found in a.c. or a.c.-d.c. receivers. Hum has several origins, enumerated in the following paragraphs:

The power supply is one. The hum is 60-cycle for half-wave rectifiers and 120-cycle for sets with full-wave rectifiers.

There may be a cathode-to-filament short. A 60-cycle signal is impressed on the cathode of the faulty tube, and the signal is amplified by each following stage.

Leakage from filament to cathode causes hum. In a mixer tube a small amount of hum due to leakage from filament to cathode modulates the r.f. carrier and is amplified by the succeeding stages. In the second detector, the small hum energy mixes a 60-cycle component with the audio signal, and this is also amplified by the succeeding stages.

All that is needed to localize hum is a small, pocket-size, insulated screwdriver. Let us approach the problem with a typical receiver. The a.c.-d.c., 5-

tube superhetrodyne shown in the drawing was taken from an RCA tube manual. It has a half-wave rectifier, a beam-power tube, a duo-diode-triode for second detector and audio amplifier, a supercontrol pentode for an i.f. amplifier, and a pentagrid converter for a combined oscillator and first detector. Most 5-tube radios have a similar circuit except that those produced recently often have selenium rectifiers instead of vacuum-tube diodes.

Assuming that the radio hums, remove the chassis from the cabinet and place it on the test bench upside down. With the aid of the insulated screwdriver, make the following very simple test:

1. Short the control grid of the power amplifier (point A in the diagram) to chassis. If the hum is still present (even though it has been reduced), the source will be found either in the output filter capacitor C1 (open or low in capacitance) or in the output tube, which may have a cathode-to-filament short. This may readily be checked by temporarily jumping a test capacitor across C1 and by replacing the power output tube with a new one of the same type.

If shorting point A to chassis eliminates the hum, the source must be ahead of this stage.

2. Short the audio amplifier control

grid (point B) to chassis with the insulated screwdriver. If the hum is still there, the R-C decoupling filter in the plate return circuit (R-C2) is defective or the tube has filament-to-cathode leakage. The tube should be replaced first; and if this does not eliminate the hum, R and C2 should be checked. When a capacitor tester is not available to test C2 for leakage or an open circuit, it should be replaced regardless of its good physical appearance. To quote an old phrase, "Don't judge a book by its cover."

If shorting point B to chassis eliminates the hum, you can bet your bottom dollar the hum originates in the stages preceding this point in the receiver.

3. Our next step is to short the diode plates (point C) to chassis. If the hum ceases, there is either a filament-to-cathode short in the duo-diode-triode or a high resistance has developed in the diode return circuit. Replacing the tube and checking the resistance of the diode return circuit (point C to chassis) should localize the fault. If hum still persists, proceed to the test outlined below.

4. With your screwdriver, short the i.f. signal grid (point D) to chassis. If the hum keeps up, it is caused by a filament-to-cathode short in the i.f. amplifier. Replace the tube.

If shorting point D to chassis eliminates the hum, there is just one more stage that can be causing the trouble—the pentagrid converter.

5. Our next step is to short the oscillator grid (point E) to chassis. If this test eliminates the hum, there is a filament-to-cathode short in the pentagrid converter.

The system we have outlined is so simple and effective that after it is used once or twice by a technician, he will resort to it often to tackle his hum problems.

In addition, the audio man will have grasped by now the thought that a screwdriver will help his hum troubles, too. Just start shorting grids.



Suggested by Harold Downs, Glen Gardner, N. J.

"You told me there was a leaky capacitor so I put the set in this pan."

RADIO-ELECTRONICS for

\*Instructor Radio Division, Delehanty Institute.

# AM Generator Useful for TV

The author describes one method of using an AM

By R. M. VENDELAND\* generator to check over-all response of TV sets

IT IS safe to assume that the radio service technician—who has fallen heir first to the automatic record changer, then FM, and finally the spinning nightmare of television—has accepted the fact that expensive equipment is necessary in his television work.

No one can deny the need for sweep generators, oscilloscopes, vacuum-tube voltmeters, and the other equipment which now finds a new home on the old service panel, but this article will introduce no new piece of equipment. All we do is show how to use that good AM signal generator that you've probably had for years—show how to use it as a check standard on the operation of a television receiver.

Rather than go into a long-winded discussion of what we are trying to do, let's take a television receiver off the shelf and demonstrate mentally the use of the old standby, the AM signal generator.

First of all, we'll connect the signal generator to the antenna terminals of the television receiver. This (by the way) is a lazy man's check because at no time during the operation does the chassis leave its cabinet. If the receiver has a 300-ohm input, just stick a 150-ohm resistor on each terminal and connect the signal generator to the resistors. **CAUTION:** if the set is a transformerless job, use an isolation transformer in the a.c. lead of the receiver, or feed the generator through a couple of capacitors. Some receivers use 75-ohm inputs and are fed with co-ax cable. Merely connect the generator across the antenna input and ground of such sets. The possible mismatch will not be important.

Next, advance the contrast control of the television receiver to three-quarters of maximum, and tune the receiver to any channel. (Signal generators not covering at least 100 mc on fundamentals will not be useful in this work. If the generator has a calibrated output or a meter measuring the r.f. output level, the methods about to be suggested can be turned into extremely accurate checks on comparative operation of different television models.)

Having selected a channel, turn the signal generator slowly toward the frequency of that channel (come from the low side). Be sure the 400-cycle modulation is turned on. As you approach the correct video carrier frequency, faint bars will appear on the television

receiver screen. As the frequency gets closer to the video carrier frequency, the bars will darken.

At this point let us stop to examine exactly what we have done and what we have checked. Thus far, we have determined that our tuner, i.f., and video amplifiers are all in working order. If any of the stages shown on the block diagram of Fig. 1 (excluding the horizontal sweep circuit) are inoperative, the bars will not appear or, if they do, will not stay locked in one position.

As the signal generator is turned to a higher frequency, the bars will reach maximum contrast on the screen of the television receiver. They should stay that way for several megacycles (a check on bandwidth). Suddenly the bars should cut off and 400-cycle tone should be heard from the speaker. (This will not happen in small receivers using intercarrier methods.) As the generator is turned *VERY SLOWLY* to a higher frequency, the sound will gradually disappear and then get louder again. See Fig. 2. The point of minimum sound should be the sound carrier frequency of the channel.

If there are two pronounced peaks of sound, the discriminator is aligned properly. If the bars do not disappear when sound is heard, the sound traps are not doing their job. (The sound traps are responsible for the sharp cut off on the high-frequency side of the over-all video response curve.) On receivers using fine tuning, a good check at this point is to set the signal generator at the actual sound carrier frequency and see if you can get a null in the sound by tuning the fine tuning control. If the oscillator is correctly aligned, that control should be at mid-position when the sound is at a null.

Actually, the bars on the screen being held in position by the vertical sync circuits, adjustment of the vertical hold control should make the number

of bars change. If they do not hold in any position of the hold control and are plainly visible as they drop across the screen, something is probably wrong with the vertical hold circuit.

For a quick check of the horizontal hold circuit, the signal generator may be externally modulated by a 15,000- or 30,000-cycle sine or square wave. This should throw one or two bars vertically on the screen. Most generators are not designed to modulate externally with much more than 10,000- or 15,000-cycle signals. As a result, a very strong sig-

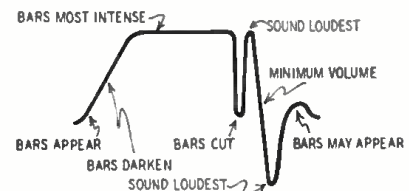

Fig. 2—The response curve of television set.

nal source will be required to get any degree of intensity on the bars. If the bars can be made to sit on end, the horizontal sync circuit is probably working. Notice that you'll have to adjust the hold control to make the bars stand on end.

In this method of testing, the advantage of a signal generator with a calibrated output is apparent. First of all, the sensitivity of the receiver can be determined by the appearance of the bars. Some sets will show bars with fewer microvolts input than others. You can set up your own standards as to which set is "hot" and which requires too much signal generator output to get the bars. You can check yourself on alignment by measuring the microvolts required to see bars on the receiver's screen. Check receivers before and after alignment to determine if you've done more harm than good (*a point that must not be taken too lightly*).

Troubles in the receiver will show either as premature falling off of the bars or as variation in intensity as you pass through the video frequencies. If, for any reason, the bars do not appear, shift the signal generator frequency to the i.f. range of the receiver and try to drive bars through the antenna circuit. If the bars appear, the oscillator is probably not functioning.

If the bars do not respond properly, change channels and check the response again. It should be obvious that proper response on one channel and improper response on another is tuner trouble.

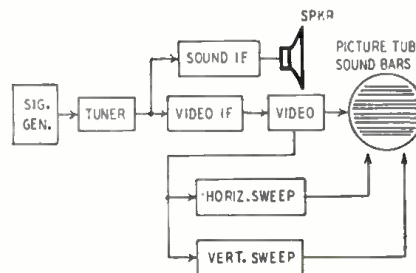

Fig. 1—Generator can check on these stages.

\*Resident Director of Television, National Radio School, Cleveland, Ohio.

# Two New Aids for TV Antenna Installation



Antenna Compass reads video voltage.

**T**WO manufacturers have recently introduced devices designed to allow one man alone to install TV antennas.

The Simpson TV Antenna Compass is made by Simpson Electric Company. Essentially a video voltmeter, the entire assembly, shown in the photograph,

is diagrammed in Fig. 1-a. A small, insulated junction box contains a 1N34 crystal rectifier, two capacitors, and a resistor. A clip fixed to the box is attached to the output of the receiver's video. The clip is provided with an insulation piercing point and is most conveniently clipped to the video input lead to the C-R tube (usually the grid lead). The ground clip is hooked to the chassis.

The rectified d.c. appearing at the output of the junction box varies directly as the video output of the set and therefore, for constant control settings, as the r.f. input. The female a.c. receptacle is connected to the male plug set in the top of the meter case. As the

antenna is rotated or a tuning stub is adjusted, maximum meter reading indicates maximum signal input.

Because of the plug arrangement, a standard a.c. extension can be used to connect the meter on the roof with the junction box attached to the set below. The installation man need only hold the meter in his hand and rotate the array for highest meter reading. Ghosts will give small peaks, but the most direct path will show up as the largest peak.

McMurdo Silver's contribution to TV installation efficiency is known as the Tennialigner, Model 914. A communicating telephone system, its chief advantages are high audio level and the lack of need for an extra line.

The antenna transmission line itself is used for communication. Fig. 1-b and the photograph tell the story. The metal cabinet contains a carbon microphone, battery, closed-circuit jack, isolation chokes, capacitors, and terminals. Chokes, microphone, and headset are provided for the other end.

The cabinet is placed close to the loudspeaker of the TV receiver. If a simple dipole is used, the microphone and headset are connected across the line at the roof. R.f. passes down the line, through the 500- $\mu$ f capacitors in the cabinet, and to the set's r.f. input. Voice currents of the telephone system find a perfect path through the r.f. isolation chokes L, but are not shorted by the receiver's input coil because of the 500- $\mu$ f series capacitors.

If a folded dipole or other d.c.-shorted array is used, one side of the line is opened upstairs and the arrangement shown in Fig. 1-b by dashed lines is used. The 300- $\mu$ f ceramic capacitor provides a path for r.f., but breaks the line for d.c. so the audio can be heard.

The downstairs cabinet is not provided with headphones, though there is a jack into which a pair can be plugged for two-way conversation. Ordinarily, the installation man on the roof can listen to the audio tone transmitted by the station and tuned in on the set during test-pattern periods, and can adjust the antenna for loudest signal.

Both these devices may be constructed by any technician. The meter circuit (Fig. 1-a) is self-explanatory. For best results, the telephone setup (Fig. 1-b) should use special low-impedance microphones and headsets, as indicated on the diagram. Telephone-type handsets or switchboard-operator head-and-chest sets will work well, if they are obtainable.

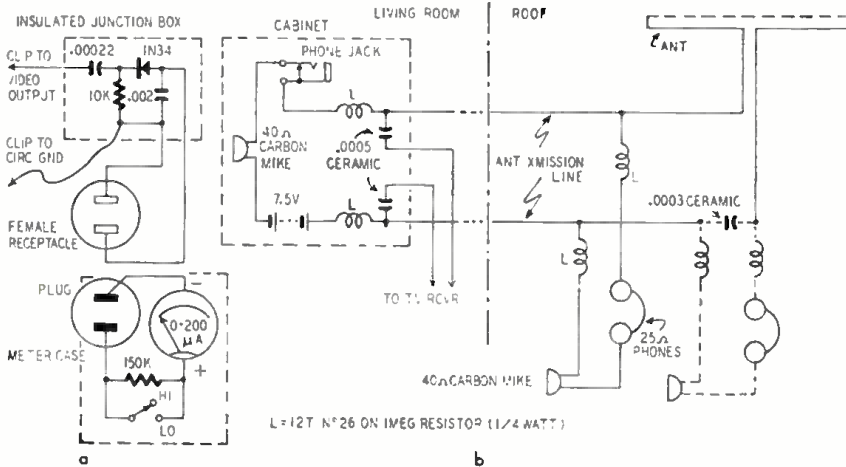
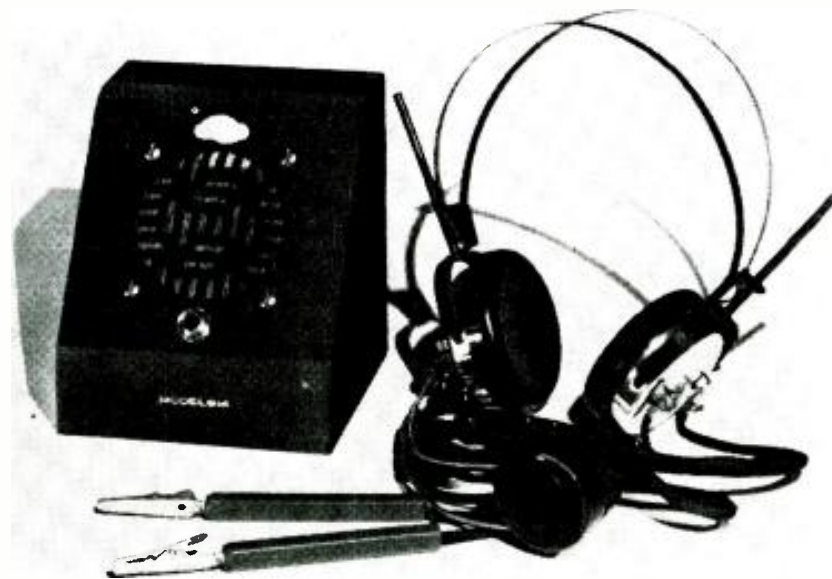

Fig. 1-a—Video voltmeter checks antenna position. b—Interphone uses antenna lead.



Case at left contains battery and microphone. Headset and other mike are used on the roof.



# it's ALLIED for hallicrafters!



**NEW**

## Hallicrafters S-72 All-Wave Portable Radio

Enjoy powerful all-wave reception wherever you go—with this superb new universal portable. The S-72 covers 540-1600 kc, 1500-4400 kc, 4.3-13 mc, and 12-31 mc. Receives standard broadcast programs, foreign and domestic short wave broadcasts, aircraft, police and Amateur stations. Has two built-in antennas—loop for standard broadcast and 27" whip for short wave. Automatic Noise Limiter; sensitivity control; AVC; BFO; main and fine tuning controls; tone control; phone jack; provision for attaching external antenna. Brown leatherette-covered plywood cabinet, 14" wide, 12 1/4" high, 7 1/4" deep. For 105-125 volts DC, or 60 cycle AC, or self-contained batteries. Complete with tubes, less batteries. Shpg. wt., 16 lbs.

97-505. Hallicrafters S-72 All-Wave Portable. **NET..... \$79<sup>95</sup>**  
 80-584. A-B Battery Pack for above. **NET..... \$3.85**

*Available on Easy Payment Terms*

**Reduced Price**

## hallicrafters S-38 the Super-Value All-Wave Receiver

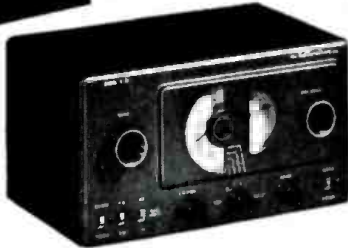

The all-star, all-wave value that amazes even the experts. Covers 4 full wave bands, continuous range from 540 kc to 32 mc. Features: full electrical bandspread; Noise Limiter; Band Selector; BFO pitch; Voice-Code switch; Speaker-headphones switch; Standby-receive switch; latest PM speaker; In handsome furniture-steel cabinet; 12x7x8". Complete with all tubes. For 105-125 volts, 25-60 cycles AC, or 105-125 volts DC. Shipping weight, 15 lbs.

97-565. Model S-38 Receiver. *Only*..... **\$39<sup>95</sup>**

**TV at New Low Cost!**

## hallicrafters T-64 TV Chassis

Complete with  
10" Picture Tube  
**ONLY**

**\$179<sup>50</sup>**

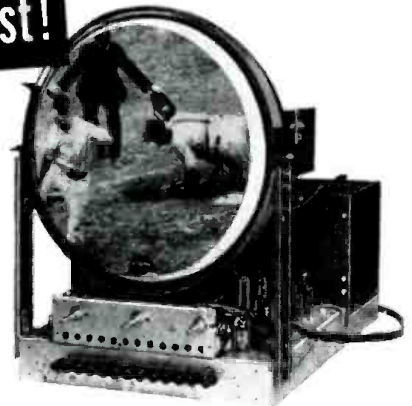

Tops for custom installations at low cost—a complete direct-view chassis for 10 or 12-inch tubes. With new Dual-Focus switch—10" tube gives you choice of big 64 sq. in. telescopic view for dramatic closeups, or large 56 sq. in. full-range view. Either way, you get a sharp picture, with fine stability and superb contrast. Features: 12 channel push-button tuning; RF amplifier; 3 IF amplifiers; 2 video amplifiers; improved sync circuits; AGC; static-free FM audio system. Complete with power supply, speaker, picture tube and 15 tubes, plus 3 rectifiers. For 105-125 volts, 50-60 cycles AC. Shpg. wt., 60 lbs.

Hallicrafters T-64 Television Chassis, complete with 10" picture tube. *Only*..... **\$179<sup>50</sup>**

Hallicrafters T-64 Television Chassis, complete with 12" picture tube. *Only*..... **\$199<sup>50</sup>**

*Available on Easy Payment Terms*

### ALLIED STOCKS ALL HALLICRAFTERS MODELS

Hallicrafters SX-42 (less speaker)	\$275.00
Hallicrafters SX-62 (less speaker)	269.50
Hallicrafters SX-43 (less speaker)	159.50
Hallicrafters S-51 (complete)	149.50
Hallicrafters S-53 (complete)	69.95
Hallicrafters HT-17 Transmitter	39.50
Hallicrafters HT-18 Oscillator	110.00

All Prices Net F.O.B. Chicago



## **FREE** Radio's Leading Buying Guide

Used by thousands of expert radio men. Get every buying advantage at ALLIED: widest selections—money-saving prices—speedy, expert shipment—personal attention—complete satisfaction on every order. Send today for your latest ALLIED Catalog.

# ALLIED RADIO

ALLIED RADIO CORP., Dept. 2-G-9  
833 W. Jackson Blvd., Chicago 7, Illinois

**FREE CATALOG**

- Send FREE ALLIED Catalog
- Enter order for Hallicrafters Model..... Enclosed \$.....
- Full Payment
- Part Payment (Bal. C.O.D.)
- Send ALLIED Easy Payment details and order blank.

Name.....

Address.....

City..... Zone..... State.....

# Designing Class-AB2 Modulators



Typical tubes used for class-AB2 modulators.

Essential design information for a class-AB2 modulator is here in convenient tabular form

By RUFUS P. TURNER, K6A1

**I**N AMATEUR radiophone design, the class-AB2 amplifier often finds use as an amplitude modulator. Almost always employing tetrode or pentode tubes, this type of modulator furnishes relatively high audio power output with less than 1 watt of grid driving power required in most cases. The class-AB2 power output, in several instances, is higher than class-B output at the same plate voltage.

Tube manufacturers have recommended certain tubes especially for class-AB2 audio service. These tubes are listed, together with their class-AB2 operating data, in the tables accompanying this article. These tables will give the modulator designer a picture of the situation and should make selecting tubes easy. With this information within reach, it will not be necessary to thumb through tube manuals in search of class-AB2 ratings for the desired output.

AUDIO POWER OUTPUT	TUBE TYPES
13W	2A5, 6F6 (6F6-G), 42
18	45
22	HY6V6-GTX
30	HY60, HY69
36	1619
47	6L6 (6L6-G)
54	2E26, 815
72	1624
75	HY6L6GX
80	RK-39, HY61, RK-807
97	HY1269
120	807, 1625
520	4-125A (4D21)

Table 1 lists the various tubes available for class-AB2 power outputs from 13 to 520 watts. Higher power outputs have not been listed because of the legal 1-kilowatt power-input limit on amateur final amplifiers. The designer may use this table to determine which, if any, tubes are available for his desired power output. Table 2 lists numerically according to tube-type num-

ber the important class-AB2 operating characteristics of these tubes.

Where two or more class-AB2 power-output levels are obtainable with a given tube, we have listed the operating characteristics corresponding to the higher power output, since this value will be of chief amateur interest.

## Class-AB2 operating hints

The class-AB2 stage must be connected in push-pull. This means that the tubes listed in Tables 1 and 2 must be used in pairs. The single exception is type 815, which itself is a dual tube. A diagram of a modulator using the 815 push-pull beam power amplifier is reproduced here from the *RCI Guide for Transmitting Tubes*.

Each design procedure applicable to push pull stages in general applies to the class-AB2 amplifier. Tubes, for example, should be matched in characteristics as nearly as practicable; non-inductive parasitic resistors (50 or 100 ohms each) should be connected in series with the control grids; and well-designed input and output transformers must be employed.

While cathode-resistor bias may be employed in a class-AB2 modulator, larger power output will be obtained with *fixed* bias. The latter is obtained from batteries; from a well-filtered, voltage-regulated a.c. power supply having low output resistance; or from an appropriate "above-ground" tap on the plate-supply voltage divider.

Input resistance, that resistance between control grid and ground in the class-AB2 stage, must be kept as low as possible, usually not more than a few hundred ohms. An *input transformer* must be employed. Phase inverters and straight resistance-capacitance coupling are not practical for class-AB2 inputs. Special class-AB2 input transformers with low-resistance secondary windings are available for input coupling and cost little more than standard inter-stage audio transformers.

If there were any considerable resistance in the grid circuit, the modulator would distort badly and would not develop peak power. The number 2 in "AB2" indicates that the grids draw current during a portion of the input voltage cycle. If grid current,

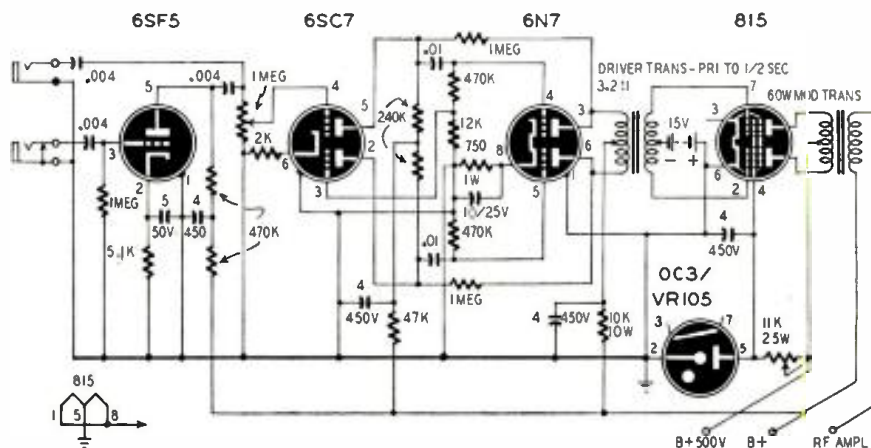

This 815 class-AB2 modulator and speech amplifier is capable of delivering about 50 watts.

RADIO-ELECTRONICS for

TABLE 2. CLASS AB2 OPERATING CHARACTERISTICS  
(Values are for 2 tubes except in the case of type 815 which is a dual tube.)

Tube Type	Filament Volts	D. C. Grid Volts	D. C. Plate Volts	D. C. Screen Volts	Max. Sig. Plate Current (ma.)	Load Resistance P to P (Ohms)	Max. Sig. Driving Power (Watts)	Max. Sig. Power Output (Watts)
2A5 <sup>2</sup>	2.5	-38	350	Screen connected to plate	92	6000	Peak a. f. grid to grid voltage 123	13
2E26	6.3	-15	500	125	150	8000	0.36	54
4-125A 4D21	5.0	-51	3000	350	260	27,700	2.5 peak	520
6F6 <sup>2</sup> 6F6-G	6.3	-38	350	Screen connected to plate	92	6000	Peak a. f. grid to grid voltage 123	13
6L6 6L6-G	6.3	-22.5 <sup>1</sup>	300	270	205	3800	0.27 peak	47
HY6L6G	6.3	-25 <sup>1</sup>	500	300	230	4,550	0.60	75
HY6V6GTN	6.3	-22.5 <sup>1</sup>	300	300	120	5000	0.40	22
RK39	6.3	-30 <sup>1</sup>	600	300	200	6660	0.40	80
42 <sup>2</sup>	6.3	-38 <sup>1</sup>	350	Screen connected to plate	92	6000	Peak a. f. grid to grid voltage 123	13
45	2.5	-68 <sup>1</sup>	275	---	138	3200	0.656	18
HY60	6.3	-22.5 <sup>1</sup>	400	225	120	6000	3.0	30
HY61	6.3	-30 <sup>1</sup>	600	300	200	6660	0.40	80
HY69	6.3	-25 <sup>1</sup>	300	300	150	4000	0.25	30
807	6.3	-32 <sup>1</sup>	750	300	240	6950	0.20	120
RK807	6.3	-30 <sup>1</sup>	600	300	200	6600	0.40	80
815 <sup>2</sup>	6.3 12.6	-15 <sup>1</sup>	500	125	150	8000	0.36	54
HY1209	12.6	-25 <sup>1</sup>	500	300	200	5000	0.70	97
1619	2.5	-16.5 <sup>1</sup>	400	300	150	6000	0.40 peak	36
1624	2.5	-25 <sup>1</sup>	600	300	180	7500	1.2 peak	72
1625	12.6	-32 <sup>1</sup>	750	300	240	6950	0.20	120

FOOTNOTES:

- <sup>1</sup> Fixed bias from d. c. supply. Do not use cathode resistor.
- <sup>2</sup> Triode-connected. Screen and plate terminals of tube socket connected together.
- <sup>3</sup> Dual tube. Both tube sections in same envelope.

flowing to ground, passed through a high resistance, a negative voltage drop would be created between grid and ground. Since this would vary directly as the input voltage during any portion of the wave, the tube would effectively be biased more and more as the signal reached its peak. The in-step bias increase would greatly reduce the tube's amplification and the plate-current waveform would be a flattened and distorted version of the input. Never use an ordinary audio "interstage" transformer.

Under excitation (full signal conditions), the class-AB2 plate current swings from a relatively low no-signal value up to a comparatively high value. The plate-voltage supply accordingly must have good regulation in order to prevent plate-voltage swings. The power supply should be capable of delivering somewhat more current than the maximum-signal plate current listed in Table 2. A choke-input type of filter is recommended.

In most class-AB2 stages, audio power output is appreciably affected by d.c. screen voltage changes. This is particularly true when beam-power tubes are used. The screen voltage accordingly must be regulated. Regulation is simple when gaseous VR-type voltage-regulator tubes are used. The

screen voltage must be obtained from a separate d.c. supply or from an appropriate tap on the plate-supply voltage divider—never through a series dropping resistor.

Class-AB2 audio-frequency driving-power requirements are modest. In most cases, less than 1 watt of driving power is recommended, as will be seen from Table 2. Grid current flows in the class-AB2 stage during a small part of the excitation cycle; hence the driver stage must be capable of supplying a small amount of power. Push-pull triodes (or triode-connected pentodes) should be used in the driver stage.

When beam-power tubes are employed in the class-AB2 modulator, it will be advisable to include in the circuit degenerative feedback to reduce the inherent distortion due to these tubes. This inverse feedback, in order to be most effective, should not be confined to the output stage; instead the feedback loop must extend from the class-AB2 output to one of the preceding voltage amplifier stages. Several satisfactory feedback circuits are to be found in the various radio handbooks and in previous issues of this magazine. The 815 is not included in the feedback loop in the RCA circuit, but there is some feedback between the plates of the 6N7 driver and the 6SC7 phase inverter.

A. N. L. AND SQUELCH CIRCUIT

A simple automatic noise limiter and squelch circuit suitable for use in communications and shortwave receivers was used in a single-channel v.h.f. receiver described in *Electrical Communication*. The noise limiter was designed to suppress ignition noise, static, and so on without distorting the a.f. signal. The squelch circuit quiets the receiver when no signal is being received.

When the squelch is off and a signal is being received, the plate of V1-a is more positive than that of V1-b because its grid is connected to a more negative point on the detector load resistors. Under this condition, diodes V2-a and V2-b conduct. The audio signal has a continuous path to the a.f. output terminals through C1, R2, and V2-a. When a peaked noise pulse reaches the receiver, it has no effect on the bias of V1-a because of the time constant of R1-C2; but the grid of V1-b goes negative, and its plate voltage rises above that of V1-a. This action causes the diodes to block and open the a.f. signal path.

This a.n.l. circuit is fast-acting because the noise pulse makes the plate of V2-a negative at the same instant that the cathode of V2-b goes positive. C3 holds its charge while the diodes are cut off, thus smoothing out the

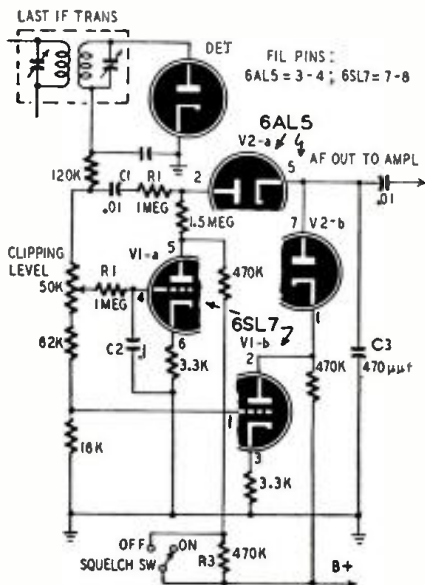

limiter operation. When the diodes are conducting, C3 follows the signal envelope. Potentiometer R2 permits the circuit to be set to block at any modulation level between 60 and 100%.

When no signal is coming in and the squelch switch is open, a 470,000-ohm resistor R3 is added to the plate load of V1-a. This makes the plate of this tube less positive than that of V1-b, and the diodes are cut off. When a signal of predetermined strength is received, the plate of V1-a goes more positive because its grid is biased higher than V1-b. The diodes conduct and permit the signal to pass through to the a.f. amplifiers. The level of the squelch is controlled by the receiver's r.f. gain or sensitivity control.

**GET INTO THE  
TELEVISION  
BUSINESS  
NOW  
WITH THE NEW  
TRANSVISION  
DEALER  
PLAN**

It brings you a sure-fire means of doing a BIG and PROFITABLE business in Television Kits, Sets, Service, and Parts.

**Just a few of the many PRACTICAL ADVANTAGES:—**

- You get an *exclusive territory* on a franchise basis.
- You get a listing in local *newspaper advertising*.
- No tie-in deals or forced purchases. No inventory problem.
- You will receive *complete information* on servicing of any and all Television Sets.
- You will receive the benefit of *free engineering advice and instruction*, plus help on all TV problems.
- A *small capital, plus ambition and foresight*—that's all you need to get ahead in television with the *Transvision Dealer Plan*.

**GET THE FACTS NOW!  
FILL OUT AND MAIL THIS  
COUPON NOW!**

Transvision, Inc., New Rochelle, N. Y.  
( ) Rush all the information on your Special new Dealer Plan.

REF: 7  
Name .....  
Address .....  
City & State .....

# A Versatile Grid-Dip Oscillator

By  
**R. L. PARMENTER,  
W1JXF**

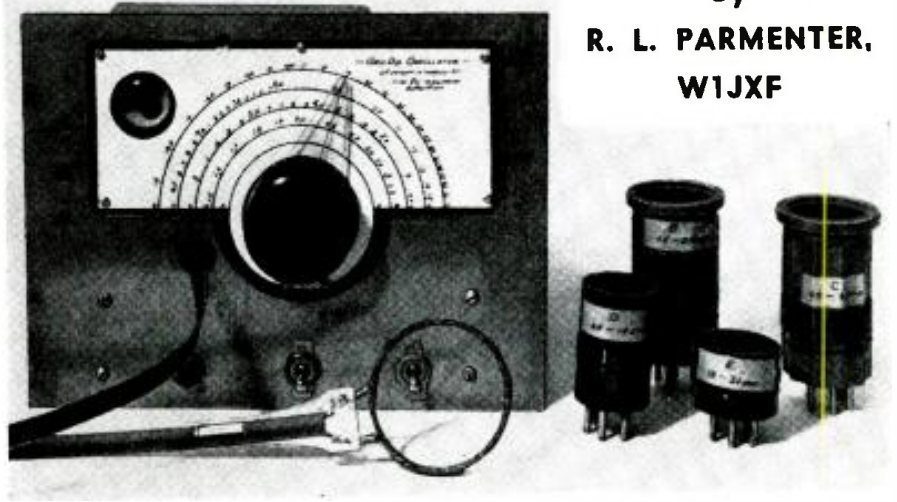

Front view of the a.c.-d.c. grid-dip oscillator. Pickup coil is below right corner of panel.

THE grid-dip oscillator has real advantages over the common, garden-variety wavemeter, and its cost can be low. Its accuracy may be high, and it can measure capacitance and inductance, as well as serving as a phone monitor when the need arises.

The oscillator circuit is the familiar Hartley, utilizing a 6C4. (A 6J5 could be substituted.) Economy dictated the use of an electron-ray tube instead of a milliammeter for the indicator. By using a 1629 (the 12-volt equivalent of the 6E5), we were able to employ the series-string idea for filament heating.

Because the current requirements are very low, the filter circuit may consist of a resistor and a dual-section electrolytic capacitor.

If power is taken from an oscillating circuit, there is a change in grid current. In this instrument the grid-current flows through the grid-leak resistor that provides bias voltage for the 1629. Any change in oscillator grid current changes the shadow on the 1629

screen because the varying voltage across the resistor is applied to the 1629 grid. The 1629 draws a minute current and presents virtually no load to the oscillator.

Plug-in coils are used for different frequency ranges. The circuit to be checked may be either directly coupled to the coil or remotely coupled by use of the link. The pickup coil is made of three turns of bell wire, held together with Scotch tape, and connected to the tuned circuit of the oscillator by a convenient length of 300-ohm ribbon line. Possibly 150- or 75-ohm line would be even better. The link coil on the oscillator end consists of three turns wound on the bottom (ground) end of each plug-in coil and spaced 1/8 inch from the main winding.

- Coil-winding data:
- 1.5-3.4 mc: 63 t. No. 26 enamel on 1 1/2-inch-diameter form. Tap at 2 t.
  - 2.9-6.6 mc: 24 t. No. 26 enamel on 1 1/2-inch-diameter form. Tap at 1 t.
  - 6.5-14.5 mc: 12 t. No. 26 enamel on

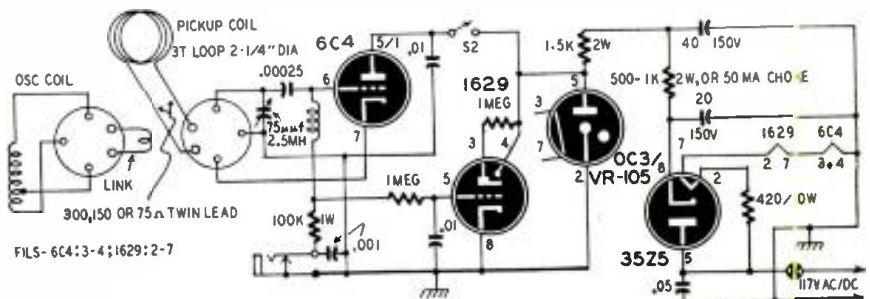

Schematic of oscillator. Note that jack frame is connected to one side of 110-volt line.

RADIO-ELECTRONICS for



# Linear Resistance Bridge

*An accurate, easily calibrated instrument*

By I. QUEEN



The bridge (left) is shown with its selenium-rectifier power supply.

THE conventional ohmmeter has serious weaknesses. For several reasons the accuracy is not all that could be desired. Each scale includes a range from zero to infinity. This cramps the calibrations, especially at the ends. Near mid-scale the readings are more reliable, but even here the meter alone may be in error by 4%. Finally, the ohmmeter scale length is usually less than 3 inches, giving rather poor readability.

A bridge measures resistance more accurately and is not affected by aging batteries or inaccurate meters. When equipped with a large dial, it is easy to read. A common circuit is shown in Fig. 1. A single potentiometer forms two arms of the bridge. As one resistance is increased, the other is reduced. This produces a nonlinear calibration similar to that of the ordinary ohmmeter. Again each scale includes the entire range of values from zero to infinity, and the readings are badly cramped, especially at the two ends. It is very difficult to estimate or interpolate between the markings on such a scale. To calibrate this circuit a whole flock of known resistors or a decade box must be used.

The bridge which appears in Fig. 2 offers several improvements, especially for home construction. In this linear-scale instrument with uniform calibration markings, the potentiometer forms

only one arm of the bridge and the dial readings are proportional to resistance in the arm. Any conventional dial may be used. In addition, error due to the potentiometer winding itself does not affect bridge accuracy as much as it does in the circuit of Fig. 1.

Calibration of the linear bridge is a cinch! After the dial and potentiometer are chosen, the calibration is completed by merely screwing the knob to its shaft. If desired, one or two points may be checked with known resistors.

Design of the linear-scale bridge is not difficult. The potentiometer is an important part of the circuit and should be a precision job, with a large-diameter winding and many turns. The ordinary volume-control type is definitely *not recommended*. The potentiometer used here is made by DeJur-Amsco. It is a 2,000-ohm unit, 2 $\frac{3}{4}$  inches in diameter, with the winding covering a 295-degree arc. A linear taper must be used.

The dial plate is an ICA job, marked 0-100, 2 $\frac{3}{4}$  inches in diameter. It gives a total scale length of over 7 inches and covers an arc of 325 degrees. This exceeds the potentiometer arc by 10% so it is necessary to add a fixed resistor in this bridge arm. This resistor must be 10% of the total potentiometer resistance, which comes out to 200 ohms. It is shown in Fig. 2.

The knob is tightened on the potentiometer shaft to point to 100 when the

potentiometer resistance is maximum. At zero resistance the knob then points to about 9, giving more than a complete decade (10-to-1) range.

The same design applies if other dials or potentiometers are chosen. First calculate the percentage by which the dial arc exceeds the potentiometer-winding arc. The added fixed resistor must equal this percentage value of the total potentiometer resistance. Then the knob is tightened to point to 100 when the entire potentiometer resistance is in the circuit. That's all there is to it.

The bridge (see photographs) is built in a box 3 x 4 x 5 inches. Its power supply (Fig. 3) measures 4 x 4 x 2 inches and is available separately for other purposes.

The ratio arm has three positions. These give dial multiplications of 10, 100, and 1,000, as shown on the diagram. Therefore a very wide range is available with a single standard. For example, with the 10,000-ohm internal standard resistor, measurements can be made from 100 to 100,000 ohms.

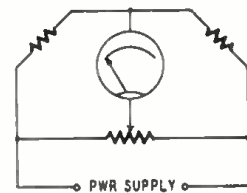

Fig. 1—Two arms vary in the standard bridge.

To measure resistance within this range, throw the standards switch to R. This connects in the internal resistor. The unknown is placed across the RX terminals. With the range switch thrown to the 22,000-ohm resistor, the bridge can measure from 100-1,000 ohms. The reading is direct except for the decimal point. For example, if balance occurs at 57.5 on the dial, the correct reading is 10 times that, or 575 ohms.

With the range switch in its middle position, the range is from 1,000 to 10,000 ohms. A 57.5 reading would mean 5,750 ohms, for example, on this range. On the high range (range switch connected to the 220-ohm resistor) the



The Sensational Model 70

# H. F. PROBE

Uses the new Sylvania IN34 Germanium Crystal Diode which combined with a Resistance-Capacity network provides a frequency range of:  
**300 CYCLES TO 100 MEGACYCLES**

**SPECIFICATIONS**  
**THE MODEL 70 AS A SIGNAL TRACER**

- Locate sources of hum.
- Locate intermitants.
- Locate cause of distortion.
- Make qualitative measurement of Signal.

**THE MODEL 70 CONVERTS YOUR V.O.M. TO A SENSITIVE, NEGATIVE PEAK-READING HIGH FREQUENCY VOLTMETER**

- Measure gain and loss in all circuits including T.V.
- Measure Q of coils and condensers.
- Check Capacity and Impedance.
- Test efficiency of oscillator circuits.
- Measure peak Voltages of sweep and triggering circuits of T.V. sets.
- Measure band-width of T.V. and F.M. sets without complicated test equipment.
- Align T.V. and F.M. sets.
- Measure frequency by using the probe with coil and condenser.

**\$3<sup>95</sup>**

complete including all instructions

**THE NEW MODEL 670**

## SUPER METER



**SUPER METER. A Combination VOLT - OHM - MILLIAMMETER plus CAPACITY REACTANCE, INDUCTANCE and DECIBEL MEASUREMENTS.**

**D.C. VOLTS:** 0 to 7.5 15 75 150 750 1500 7500  
**A.C. VOLTS:** 0 to 15 30 150 300 1500 3000  
**VOLTS:** 0 to 15/30 150 300 1500 3000  
**D.C. CURRENT:** 0 to 1.5/15 150 ma.; 0 to 1.5 Amps.  
**RESISTANCE:** 0 to 500 100,000 ohms, 0 to 10 Megohms  
**CAPACITY:** .001 to .2 Mfd., .1 to 1 Mfd. (Quality test for electrolytics.)  
**REACTANCE:** 200 to 27,000 Ohms; 13,000 Ohms to 3 Megohms  
**INDUCTANCE:** 1.75 to 70 Hentles; 35 to 8,000 Hentles  
**DECIBELS:** -10 to +18, +10 to +38, +30 to +58

The model 670 comes housed in a rugged, crackle-finished steel cabinet complete with test leads and operating instructions. Size 5 1/2" x 7 1/2" x 3". **\$28<sup>40</sup>** NET

**THE NEW MODEL 247**

## TUBE TESTER



Check octals, loctals, bantam Jr. peanuts, television miniatures, magic eye, hearing aids, thyracons, the new type H.F. miniatures, etc.

- Features:**
- A newly designed element selector switch reduces the possibility of obsolescence to an absolute minimum.
  - When checking Diode, Triode and Pentode sections of multi-purpose tubes, sections can be tested individually. A special isolating circuit allows each section to be tested as if it were in a separate envelope.
  - The Model 247 provides a super-sensitive method of checking for shorts and leakages up to 5 Megohms between any and all of the terminals
  - One of the most important improvements we believe is the fact that the 4-position fast-action snap switches are all numbered in exact accordance with the standard R.M.A. numbering system. Thus, if the element terminating in pin No. 7 of a tube is under test, button No. 7 is used for that test.

Model 247 comes complete with new speed-read chart. Comes housed in handsome hand-rubbed oak cabinet sloped for bench use. A slit-on portable hinged cover is included for outside use. Size: 10 1/4" x 8 3/4" x 5 1/4". **\$29<sup>90</sup>** NET

**20% DEPOSIT REQUIRED ON ALL C.O.D. ORDERS**

**MONEY BACK GUARANTEE**—We believe units offered for sale by mail order should be sold only on a "Money-Back-If-Not-Satisfied" basis. We carefully check the design, calibration and value of all items advertised by us and unhesitatingly offer all merchandise subject to a return for credit or refund. You, the customer, are the sole judge as to value of the item or items you have purchased.

**The New Model 770 — An Accurate Pocket-Size**

## VOLT-OHM MILLIAMMETER

(Sensitivity: 1000 ohms per volt)



**Features:**  
Compact-measures 3 1/4" x 5 1/2" x 2 1/4". Uses latest design 2% accurate 1 Mil. D'Arsonval type meter. Same zero adjustment holds for both resistance ranges. It is not necessary to readjust when switching from one resistance range to another. This is an important time-saving feature never before included in a V.O.M. in this price range. Housed in round-cornered, molded case. Beautiful black etched panel. Depressed letters filled with permanent white. Insures long-life even with constant use.

**Specifications:** 6 A.C. VOLTAGE RANGES: 0-15 30 150 300 1500 3000 volts.  
6 D.C. VOLTAGE RANGES: 0-7 1/2/15/75/150 750 1500 volts.  
4 D.C. CURRENT RANGES: 0-1 1/2/15/150 Ma. 0-15 Amps.  
2 RESISTANCE RANGES: 0-500 Ohms, 0-1 Megohm

The Model 770 comes complete with self-contained batteries, test leads and all operating instructions. **\$13<sup>90</sup>** NET

**The Model 88 — A COMBINATION**

## SIGNAL GENERATOR AND SIGNAL TRACER

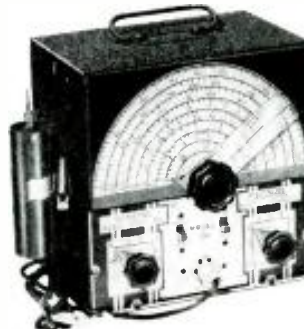

**Signal Generator Specifications:**  
\*Frequency Range: 150 Kilocycles to 50 Megacycles. \*The R.F. Signal Frequency is kept completely constant at all output levels. \*Modulation is accomplished by Grid-blocking action which is equally effective for alignment of amplitude and frequency modulation as well as for television receivers. \*R.F. obtainable separately or modulated by the Audio Frequency.

**Signal Tracer Specifications:**  
Uses the new Sylvania IN34 Germanium crystal diode which combined with a resistance-capacity network provides a frequency range of 300 cycles to 50 Megacycles. **\$28<sup>85</sup>** NET

The Model 88 comes complete with all test leads and operating instructions. ONLY

**GENERAL ELECTRONIC DISTRIBUTING CO.** Dept. RG-7, 98 PARK PLACE NEW YORK 7, N. Y.

# NEW TELEKITS

## NOW \$59.50

Jobbers: Write for Price Information

**NEW TELEKITS**  
 10-B \$82.99  
 7-B \$59.50



Sparkling new Telekit 10-B has 52-inch screen. Brand new compact lay-out has video tube mounted on chassis. Big illustrated easy-to-follow instruction book guides you step by step through easy assembly. No special knowledge of television is required. All you need is a soldering iron, pliers, and screw driver. Telekit 10-B, \$82.99. Tube kit, including 10BP4 and all other tubes, \$55.80. 10-B Telekit cabinet \$24.50. Telekit Guarantee includes free factory service.

Write for catalog listing 10-B and 7-B Telekits. New 7-B Telekit for 7-inch tube, \$59.50. Tube kit, including 7JP4, \$41.58. 7-B cabinet, \$24.50.



Note simple clean lay-out for easy assembly of new Telekit 10-B. Features 2 sound I. F. stages, a new pre-built, pre-aligned tuner that includes a stage of R. F. for distance reception. Easy-to-adjust horizontal lock circuits. Beautiful new model cabinets for 7-B and 10-B are heavily constructed of hand rubbed walnut.

**13 CHANNEL TUNER**  
 \$19.95



**NEW 13 CHANNEL TUNER** is a small compact unit with stage of R.F. Tunes all TV and FM channels. Made to conform with Telekit or any other TV set having video I.F. of 25.75 Mc. Complete with tubes, pre-wired, pre-aligned; only three connections to make. See your jobber, or write to us for information. Your cost, \$19.95.

Write for catalog of Telekit antennas, boosters, television kits, tuners, television parts and tubes.

**TELEKIT**  
 ELECTRO-TECHNICAL INDUSTRIES  
 1432 NORTH BROAD STREET PHILADELPHIA 7, PA.

bridge measures from 10,000 to 100,000 ohms. Here a 57.5 reading would actually mean 57,500 ohms, a multiplication by 1,000.

Resistors less than 100 ohms are measured by noting the difference when they are added in series with another resistor. For example, a 150-ohm resistor is measured on the low range as 150 ohms. Suppose now that an unknown is added in series with this resistor and that the reading goes up to 175. Then the unknown resistor is 175—150 or 25 ohms.

For resistors higher than 100,000 ohms, the standards switch is thrown to X (external). Again the unknown is

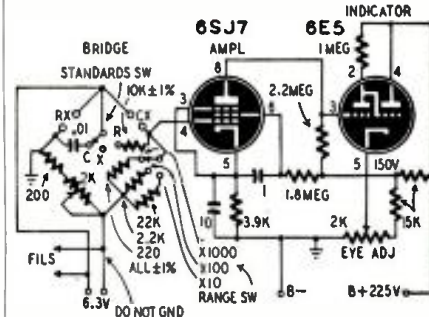

Fig. 2—This bridge is simple but effective.

connected across the RX terminals, and the standard is placed across the other pair (CX terminals). The answer is now calculated from

$$RX = \frac{\text{range} \times \text{standard} \times \text{dial}}{10,000}$$

When the range switch is thrown to the  $\times 100$  position, the unknown may always be read as a percentage of the standard. As an example, assume balance is reached with the ratio switch on 100, the dial on 89.5, and a standard of 1 megohm. By either calculation, the answer is 895,000 ohms, or 89.5% of 1 megohm.

Balance is indicated on a 6E5 electron-ray tube which is preceded by a 6SJ7 amplifier. First the eye is adjusted to show a narrow angle. As balance is approached, this angle increases until it is about 90 degrees. When the adjustment is correct, the sensitivity is very high. For example, when balance occurs at 90, the eye shows a distinct unbalance at  $90\frac{1}{2}$  and unbalances again at  $89\frac{1}{2}$ .

The resistors used in the bridge may be the metallized type or wire-wound. The latter is preferred. In any case they should be as accurate as possible and noninductive. The bridge made here gives results accurate to about one-half dial division at any part of the dial, when compared with a good laboratory bridge. Near the upper end of the dial this accuracy is better than 1%!

For measuring capacitance, the procedure is similar to the above. Throw the standards switch to C and connect the unknown across CX. Dial readings are in  $\mu\text{f}$  instead of ohms, and are direct-reading as before. The range is from 100 to 100,000  $\mu\text{f}$ . An external capacitor standard may be used by throwing the standards switch to X, and connecting the standard across the RX terminals.

Capacitors do not give as sharp a balance, but there is ample sensitivity. It takes about two or three divisions to show a definite unbalance as against one-half division or less on resistors. For greater sensitivity, use a 1,000-cycle oscillator instead of the power frequency or increase the 6 volts to about 20.

Several 6.3-volt transformers were tried here, and it was found that some introduced an error in measuring capacitance. In some cases the dial reading was always two or three divisions too high, and when the transformer secondary was reversed, the reading was the same number of divisions too low. This error, where it existed, was always a constant number of divisions anywhere on the dial and on every range setting, making it easy to apply a correction factor in order to obtain a correct result.

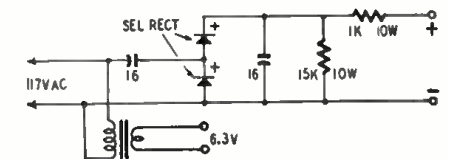
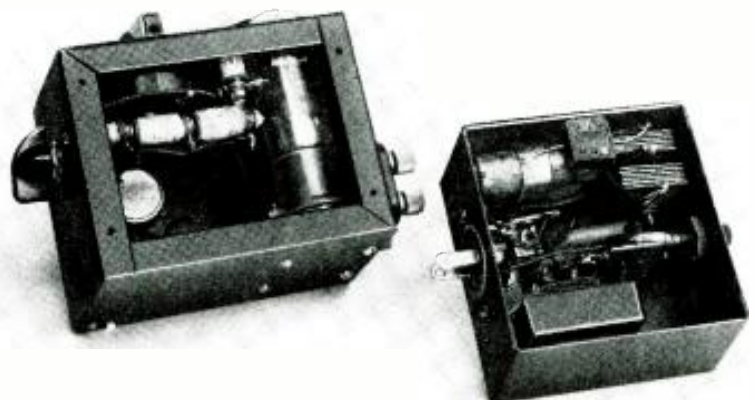

Fig. 3—The power supply can have many uses.

For inductance measurement, a 1,000-cycle oscillator is preferable for the bridge power supply. Use the same test terminals RX as for resistance measurement.



Under-views of the bridge and power-supply chassis show the compactness of the construction.



The New Model TV-20—A Combination

# 20,000 OHMS PER VOLT MULTI-METER AND TELEVISION KILOVOLTMETER



The Model TV-20 was designed to provide all the multi-meter measurement requirements of A.M., F.M. and Television. Unlike other recent models, which are actually standard V.O.M.'s converted to test the new Television Voltages, the Model TV-20 is a completely new unit. It provides the sensitivity, ranges and accessories which are needed to service F.M. and Television in addition to A.M. Radio. The High Voltage Probe, for example, with a range of 50,000 volts and designed to withstand 100,000 volts, is an integral part of the instrument with a special compartment for housing it when not in use.

## SPECIFICATIONS

**8 D.C. VOLTAGE RANGES:** (At 20,000 ohms per Volt)  
0-2.5/10/50/100/250/500/1,000/50,000 Volts

**7 A.C. VOLTAGE RANGES:** (At 1,000 ohms per Volt)  
0-2.5/10/50/100/250/500/1,000 Volts

**5 D.C. CURRENT RANGES:** 0-5/50/500 Milliampers  
0-50 Microampers 0-5 Amperes

### 4 RESISTANCE RANGES:

0-2,000/20,000 ohms 0-2/20 Megohms

**7 D.B. RANGES:** (All D.B. ranges based on  
0Db=1 Mv. into a 600 ohm line)

-4 to +10 db +22 to +36 db +36 to +50 db

+8 to +22 db +28 to +42 db +42 to +56 db

+48 to +62 db

**7 OUTPUT VOLTAGE RANGES:** 0 to 2.5/10/50/  
100/250/500/1,000 Volts

### ADDED FEATURE

The Model TV-20 includes an Ultra High Frequency Voltmeter Probe. A Silicon V.H.F. Diode together with a resistance capacity network provides a frequency range up to 1,000 MEGACYCLES. When plugged into the Model TV-20, the V. H. Probe converts the unit into a Negative Peak-Reading H.F. Voltmeter which will measure gain and loss in all circuits including F.M. and T.V.; check capacity and impedance; test efficiency of all oscillator circuits; measure band-width of F.M. and T.V.; etc.

The Model TV-20 operates on self-contained batteries. Comes housed in beautiful hand-rubbed oak cabinet complete with portable cover, Built-In High Voltage Probe, H. F. Probe, Test Leads and all operating instructions. Measures 4½" x 10¼" x 11½". Shipping Weight 10 lbs.

Net price

20% DEPOSIT REQUIRED ON ALL C.O.D. ORDERS

### MONEY BACK GUARANTEE

—We believe units offered for sale by mail order should be sold only on a "Money-Back-If-Not-Satisfied" basis. We carefully check on the design, calibration and value of all items advertised by us and unhesitatingly offer all merchandise subject to a return for credit or refund. You, the customer, are the sole judge as to value of the item or items you have purchased.

# \$39<sup>95</sup>

## GENERAL ELECTRONIC DISTRIBUTING CO.

Dept. RC-7, 98 Park Place  
New York 7, N. Y.

# European Report

By Major Ralph W. Hallows

RADIO-ELECTRONICS LONDON CORRESPONDENT

...Help end  
spark plug  
**INTERFERENCE**



Spark Plugs are miniature broadcasting stations, send signals that interfere with radio reception, distort television. The New Auto-Lite "Resistor" Spark Plug reduces this interference.\*



Recommend **NEW**  
**AUTO-LITE**  
*Resistor*  
**SPARK PLUG**

Here's How It Works to End Interference

The "Resistor" acts to dampen the spark plug radio signal to an acceptable level\* while still delivering the full high voltage discharge required to ignite the fuel.

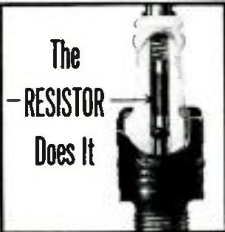

Auto-Lite Ignition Engineers, working with leading automotive manufacturers, have developed the new Auto-Lite "Resistor" Spark Plug with this built-in resistor that reduces spark plug interference.\* Remember, the "Resistor" also helps deliver smoother idling, improved economy, longer electrode life. Dealers are being supplied as rapidly as possible. Write for Booklet M-1186 for full information.

THE ELECTRIC AUTO-LITE COMPANY  
Toronto, Ontario Toledo 1, Ohio

\*Under 35mv/m from 540 kc. to 150 mc. at 50 ft.



**S**OMETHING really new in amplifying tubes has now reached the advanced experimental stage of development here. Readers don't need to be reminded of the need that is so urgently felt in both your country and mine for tubes that will operate efficiently as wideband amplifiers at frequencies of 40 mc and above. Unless and until they come along, we are not likely to achieve the very-high-definition television that is the goal of present-day research. The new planar-electrode tubes under development by the Marconi-Osram Valve Co. strike out on an entirely new line in design and construction. So far only triode types have been produced; but as these combine an amplification factor of 40 with a mutual conductance of 8 ma per volt (8,000  $\mu$ mhos) and exceedingly small input and output capacitances, they represent both a big step forward in design.

The characteristics of the experimental triode E1714 are:

Heater potential	..... 6.3 volts
Heater current	..... 0.5 amps
Plate potential	..... 250 volts
Amplification factor	.... 40
Mutual conductance	.... 8 ma/v
Plate current at 150 volts	10 ma
$C_{pk}$	..... 2.9 $\mu$ mf
Total $C_p$	..... 3.8 $\mu$ mf
$C_{ca}$	..... 0.9 $\mu$ mf
Total $C_o$	..... 2.0 $\mu$ mf

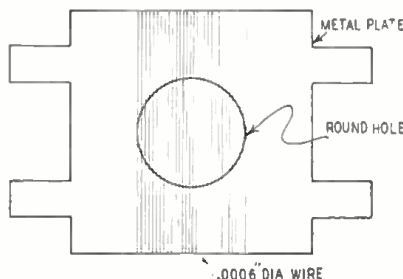

Features of the new planar-electrode tubes: grid aperture (left) and electrode placement.

The high mutual conductance means a good signal-to-noise ratio, one of the most important features of a satisfactory v.h.f. amplifying tube. To obtain this, together with a small transit time, the following basic requirements must be met: (1) the cathode must be of small area, (2) the cathode-grid spacing must be close, and (3) the current density must be high.

The Marconi-Osram research staff has broken away entirely from the cylindrical electrode systems employed in acorn and other v.h.f. tubes. Their method is to use flat electrodes; hence the term *planar*. Fig. 1 shows the construction of the grid. Very fine wires (0.6 mil in diameter) are closely spaced across a circular aperture in a flat metal plate.

Inside the bulb the electrodes are mounted horizontally on a slotted mica bridge, as shown in Fig. 2. The spacing between cathode and grid is only .003 inch. Both anode and cathode are cylindrical in form, only the operating surfaces of each being close to one another. Stray capacitances are thus brought down to a minimum. It is stated that these new triodes operate very satisfactorily in 45-mc amplifiers with a bandwidth of 12-15 mc.

(Planar electrodes have been used in American disk-seal u.h.f. tubes for some time.—*Editor*)

## Tv frequencies

Britain has five channels in the 40-68-mc television band, and the way in which these are to be used has just been announced. The London station transmits both vision sidebands symmetrically and it is not proposed to alter this, since some single-sideband televisions in use are designed to handle the upper sidebands and some the lower. However, there would not be room for five sound and five vision channels in the band if other stations operated in the same way. For that reason all new stations will be asymmetric. Both sidebands will be radiated up to 750 kc without attenuation; but for vision frequencies above 750 kc the upper sideband will be heavily attenuated. The lower sideband will extend to 2.75 mc.

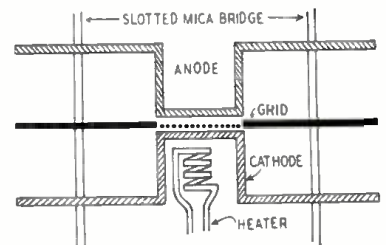

making the total vision passband  $0.75 + 2.75 = 3.5$  mc. The channels are arranged in the following way:

Channel No.	Sound (mc)	Vision (mc)
1 (London)	41.5	45
2	48.25	51.75
3	53.25	56.75
4 (Birmingham)	58.25	61.75
5	63.25	66.75

**Seven-grid tube**

I wish I had the space to tell you about all the wonderful things shown at the Physical Society's exhibition in London. Here are one or two of them. First of all the monode, which is *not* a transmission line showing no nodes, but a tube with nine electrodes. Nine? Yes! Cathode, anode, and no less than seven grids! Two of these are control grids, one is a suppressor, and all the rest do shielding jobs. The important point about the tube is that it won't pass current unless both control grids are simultaneously above a certain minimum potential. Now perhaps you begin to see a ray of daylight; the tube is designed to serve as a combined detector and limiter in FM receivers. One control grid is connected to the primary and the other to the secondary of the i.f. transformer; hence, both receive the FM signal and the frequency modulation is converted into phase modulation. In the anode circuit, pulses of current are produced with a duration governed by the phase modulation. We thus have what amounts to pulse-width modulation. Apply that to an integrator circuit, and the result is amplitude modulation. This may seem rather a long way round, but it works. It does detect, and it does limit satisfactorily. And this single tube does even more, for its output is sufficient to be applied directly to the grid of the output tube.

**How salt is sea water?**

You might not think offhand that a tuned r.f. circuit is a very handy means of measuring the degree of salinity of sea water. One of the Admiralty Research Station's exhibits showed, however, that it is just the thing to use—if you know how. What they do is introduce some of the water to be measured into a container in the circuit. Measurement of the alteration in Q that takes place gives the required answer.

Nor, perhaps, might you think at first blush that an ultrasonic generator would be much help if you wanted to tackle the most difficult of all soldering jobs—soldering aluminum. The trouble with this metal is that a clean surface can't be obtained by ordinary methods. Scrape it and it oxidizes instantly, before any of the usual fluxes can get at it. The oxide film prevents solder from "wetting" the metal. And there you are—or, rather, there you aren't! That's where the ultrasonic transducer comes in. Apply it to the aluminum to be soldered, and the rest is easy, as the Mullard Company demonstrated. The agitation breaks up the film of oxide, allowing the solder to wet the surface of the metal.

JULY, 1949

## ARE YOU RECTIFIER-WISE?

### WIN A VALUABLE PRIZE

**With your Circuit Designs Using Federal's  
Miniature Selenium Rectifiers**





Here is your opportunity to convert your circuit ingenuity into a useful and valuable prize. Federal, the originator of the Miniature Selenium Rectifier, is interested in your ideas on the use of this revolutionary circuit element.

A multitude of circuits have been built around the outstanding characteristics of Federal's complete line of Miniature Selenium Rectifiers—audio amplifiers, home radios, television receivers, 'ham' transmitters, FM adapters, phonograph amplifiers and many other electrical and electronic circuits. They all capitalize on the long life, high current capacity, instantaneous starting and great efficiency of these rectifiers. This compact, lightweight television power supply is typical.

These are but a few applications. The uses of these Miniature Rectifiers are almost unlimited. Get your idea down on paper and send it in today. It may be a prize winner!

#### CONTEST DETAILS

- All entries must be original circuits.
- All entries become the property of Federal Telephone and Radio Corporation.
- Federal engineers will judge entries on basis of novel and useful applications and select winning circuits.
- Five winners will be selected from the entries received during each month of the contest. A grand prize will be awarded to the outstanding entry of the contest.
- All entries must be received by the contest final closing date—July 31, 1949. Mail your entry to Contest Box A.
- Winners will be announced.

#### FIVE MONTHLY PRIZES AND A GRAND PRIZE



The five monthly winners will each receive, FREE, a Federal FTR-1342-AS Selenium Rectifier Power Supply Battery Charger. This compact unit, with its 6-volt, 6-ampere DC output, has many uses in home and shop. It comes equipped with a handy under-dash mounting socket for automobile battery charging.



The grand prize, a Federal FTR-3246-BS Radio Service Power Supply, is invaluable as a source of heavy duty, filtered DC power. Its 6-volt, 10-ampere DC output will handle auto radio testing and many other test and permanent power requirements. List price \$74.50.

**MAIL YOUR ENTRY TO: MINIATURE RECTIFIER CONTEST**  
*Federal Telephone and Radio Corporation*  
SELENIUM INTELIN DIV. • 900 PASSAIC AVENUE • EAST NEWARK, NEW JERSEY

## GEIGER COUNTERS

**HAMS! BE FIRST AGAIN! BUILD YOUR OWN!**  
Find radium, trace water mains, prospect, check local contamination, assay ores.

**SENSATIONAL BETA COUNTER:**  
30 MG CM<sup>2</sup> WALLS

<input type="checkbox"/> Send Beta counter	\$7.50
<input type="checkbox"/> Send complete parts kit and diagram	\$48.50
<input type="checkbox"/> Send assembled 5.5 pound portable	\$90.00
<input type="checkbox"/> Send 110VAC quantitative lab. model	\$150.00
<input type="checkbox"/> Send detailed information <input type="checkbox"/> Check <input type="checkbox"/> COD	

AEC Bulletins available

### COSMIC COUNTERS

112 Cornell Ave. Swarthmore, Pa.



### FITTINGS for your BEAM ANTENNA

Speed the building of a neat, fully adjustable, all aluminum job.

Type HASL aluminum bracket attaches half inch tubing to 1/4" center tube, 4 for **\$3.75**

Ask for circular showing fittings for TV, FM 2, 10 and 20 meter beams.

**D. H. HARRELL COMPANY**  
315 Fourth Street Logansport, Indiana

### Radio eqt. for sale.

1—Hickok 288X signal generator, A.M. F. M.	\$110.00
1—Hickok 507 scope	\$115.00
Rider's manuals 29 thru 311, Each	\$12.00

Everything in brand new condition

**DEALERS RADIO**  
2009 Roanoke St. W. Hyattsville, Md.

## S-T-R-E-T-C-H

YOUR DOLLARS  
WITH THIS BIG  
180 PAGE  
**FREE**  
CATALOG



**TELEVISION, ELECTRONIC PARTS, HIGH-FIDELITY RADIO, HAM GEAR, PUBLIC ADDRESS EQUIPMENT, PARTS AND WORKSHOP TOOLS**

Write today for the 1949 Lafayette-Concord catalog. A penny postcard will do the trick. You'll find pages and pages of the finest equipment at new, low prices. Use the catalog to order everything you need and save both time and money. You'll like shopping from this mammoth bargain guide.

Write for your copy today. It's free!

## LAFAYETTE-CONCORD

World's largest radio supply organization

LAFAYETTE-CONCORD,  
Dept. JG-9  
100 Sixth Avenue, New York 13  
901 West Jackson Blvd., Chicago 7

Please rush free catalog No. 89

Name .....

Address .....

City.....Zone.....State .....

**FREE!**

**CUT ALIGNMENT TIME IN HALF!**  
ON ALL FM AND TV TESTING JOBS

**FERRET'S NEW 720 SWEEP GENERATOR**



**"PAYS FOR ITSELF IN TIME SAVED"**  
say Successful Users

Push button control. Standby button. More sweep width. Coverage on fundamentals 0-260 MC on eight bands; 50 KC-20 MC on all bands. Marker frequency 19 to 40 MC. Entirely electronic—no vibrators or speakers.

Don't buy any equipment until you SEE FERRET'S full line of FM-TV Test Instruments and COMPARE FERRET quality and prices.

All FERRET Equipment is fully guaranteed  
Ask your distributor for demonstration—or write for information.

**ENTIRELY ELECTRONIC**  
The only Sweep Generator employing an electronic sweep in the reasonably priced class!

**Ferret EQUIPMENT**

America's Most Advanced FM-TV Test Equipment

COASTWISE ELECTRONICS CO. • 130 N. Beaudry Ave. • Los Angeles 12, Calif.

**Be a "Forty-Niner" in '49**

**THE "FORTY-NINER" GEIGER COUNTER**

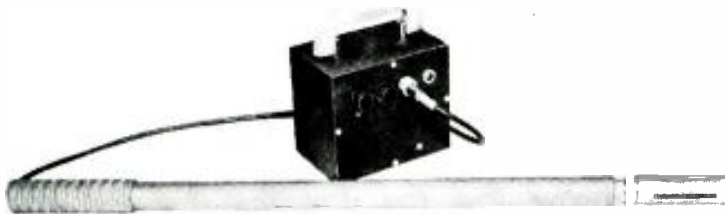

- Lightweight uranium detector.
- Detects beta and gamma rays.
- Equipped with 36 inch search probe.
- Contains two 67½ volt Minimax batteries in the well-known type of relaxation oscillator supply.

Weight 4½ lbs. complete; size 4"x5"x6". Beautifully finished case with handle. Price \$89.50. Complete with four tubes, including Geiger tube, batteries, search probe and ear-phone.

**THE FORTY-NINER CO.**

5245 Grand River, Detroit 8, Mich.

**Check these Prices!**

**SELENIUM RECTIFIERS**  
115 VOLTS



For Radio & Television Application

fully guaranteed	lots of 10, each	lots of 100, each
75 M.A.	.56	.50
100 M.A.	.64	.56
150 M.A.	.72	.64
200 M.A.	.89	.78
250 M.A.	1.16	.88

**OPAD-GREEN COMPANY**

71 Warren St., N. Y. 7, N. Y. BEEKMAN 3-7385-6

**Get Started in Radio**



**10 "HOW-TO-DO-IT" BOOKS**

Get a solid foundation in radio by means of these 10c timely text books. Each clearly written, profusely illustrated, contains over 15,000 words. You'll be amazed at the wealth of information packed into these handy books. Excellent for reference—ideal for technical library. Your money back if not satisfied.

**5 BOOKS for 50c**

**10 BOOKS for \$1.00**

**Sent to You Postpaid**

- |  |                                     |
|--|-------------------------------------|
| No. 1—How To Make Four Doerle Short Wave Sets                      | No. 6—How To Have Fun With Radio    |
| No. 2—How To Make The Most Popular All-Wave 1 and 2 Tube Receivers | No. 7—How To Read Radio Diagrams    |
| No. 3—Alternating Current for Beginners                            | No. 8—Radio for Beginners           |
| No. 4—All About Aerials  | No. 9—Simple Electrical Experiments |
| No. 5—Beginners' Radio Dic   | No. 10—Television                   |

Remit by check or money order—register letter if you send cash or stamps.

**RADIO PUBLICATIONS**

23M West B'way. New York (7)

**NOVEL SPEAKER PLACEMENTS**



Kolster-Brandes arrangement diffuses treble.

The two unusual-looking phonographs pictured are products of European manufacturers. The Kolster-Brandes (England) Model CRP20 shown above has a speaker built on a shelf, facing downward. A metal conical flare is so placed below it that the high frequencies are reflected from the bottom and rear of the cabinet into the room. The maker states that the highs are diffused over a large portion of the room, rather than being beamed out directly in front of the speaker as is the case with ordinary cabinets.

The lower photo shows the Maraja, made by Officine Radionda (Italy). Representing a new (and somewhat



This Italian set has a very novel appearance.

startling to American eyes) style, the turntable and amplifier are built into the table-top, while the speaker is mounted facing down in the center support structure.

Both models are also offered with radio receivers.

RADIO-ELECTRONICS for

## 3-SPEED DISC PLAYER

Newcomb Audio Products Co.  
Hollywood, Calif.

This player will handle all types of records now in use for reproduction of program material—7-, 10-, 12- and 16-inch discs, at 33 1/3, 45- and 78 r.p.m. Two pickups are used for the 12-inch and standard grooves. The amplifier has push-pull 6V6 output tubes with feedback, giving 10 watts of audio. A 12-inch PM speaker is mounted in the case lid. Bass-boost and treble tone controls are provided.



## RESONANCE INDICATOR

McMurdo Silver Co., Inc.  
Hartford, Conn.

Model 915 is a metal case containing a meter and a few small components, but no tubes. When the output of a signal generator is connected to the instrument and the probe coil connected to the meter is brought in or a circuit tuned to the generator frequency, the meter dips. Three probe coils are provided, covering 100 kc to 300 mc. The unit is used in the same manner as a grid dip meter.



## RADIATION METER

Nucleonic Corp. of America  
Brooklyn, N. Y.

Model RM-1 radiation meter is a portable survey instrument (see article on uranium prospecting in this issue).



High voltage—obtained from 67 1/2-volt batteries—is variable from 400 to 1500 to permit use of end window or cylindrical G-M tubes. A meter covers three count ranges, 5,000, 50,000, and 500,000 per minute. Earphones are supplied.

## 7-INCH DISC CHANGER

Webster-Chicago Corp.,  
Chicago, Ill.

The Duo-Seven is a record changer with a new philosophy. Designed for 7-inch discs only, it will play both Victor and Columbia products (33 1/3 and 45 r.p.m.). The size of the unit is similar to that of RCA's 45 r.p.m. changer; music to music change cycle occupies about 3 seconds depending on the number of dead grooves in the discs. Complete players with amplifiers and

speakers will be offered as well as changer cabinet assemblies to be connected to external rod or amplifiers.

## SIGNAL GENERATOR KIT

Rodio Kits, Inc.,  
New York, N. Y.

Model SG2 signal generator covers 150 kc to 32 mc on fundamentals and is



useful on harmonics up to about 100 mc. A 400-cycle modulation tone may be switched in. The kit is supplied with blueprints and step-by-step instructions.

## NEW MICROPHONES

Electro-Voice, Inc.,  
Buchanan, Mich.

Mercury microphones are available as crystals or dynamics. Frequency response extends from 50,000 cycles. Output level is -48 db for the crystal (Model 911) and -53 for the dynamic (Model 611). The case is pressure-cast and finished in satin chromium. The dynamic is available in high and low impedances.



## 16-INCH GLASS TUBE

Zetka Television Tubes, Inc.,  
Clifton, N. J.

The first available 16 inch glass television tube is now being produced. The tube has a flat face and an ion trap. It is 1 inch shorter than the 15 inch glass tube, and 2 inches shorter than the 16-inch glass-and-metal tube.

## FM-AM SIG GENERATOR

Sylvania Electric Products, Inc.,  
New York, N. Y.

The new FM-AM signal generator, type 216, provides accurate, high-level signals from 90 kc to 120 mc for aligning receivers. Amplitude modulation is available on frequencies up to 60 mc. An output meter is provided. FM sweeps of 350 kc in each direction of 60 cycles or 75 kc at 400 cycles may be had up to 120 mc. A 15-kc sweep is obtainable up to 61 mc. Accuracy of calibration is 0.5%.



# AMPHENOL ANTENNAS

## for every FM or TV Requirement

An efficient, high-gain antenna is imperative for TV reception, and Amphenol leads with the finest attainable. Highly trained and highly skilled Amphenol engineers have produced the most effective high and low band antennas and are continually making improvement as new ideas are developed. Constructed of aluminum tubing and aluminum alloy castings, Amphenol antennas have high forward gain combined with high front-to-back and front-to-side ratios, insuring maximum pickup and lasting enjoyment to the user.

**TV**

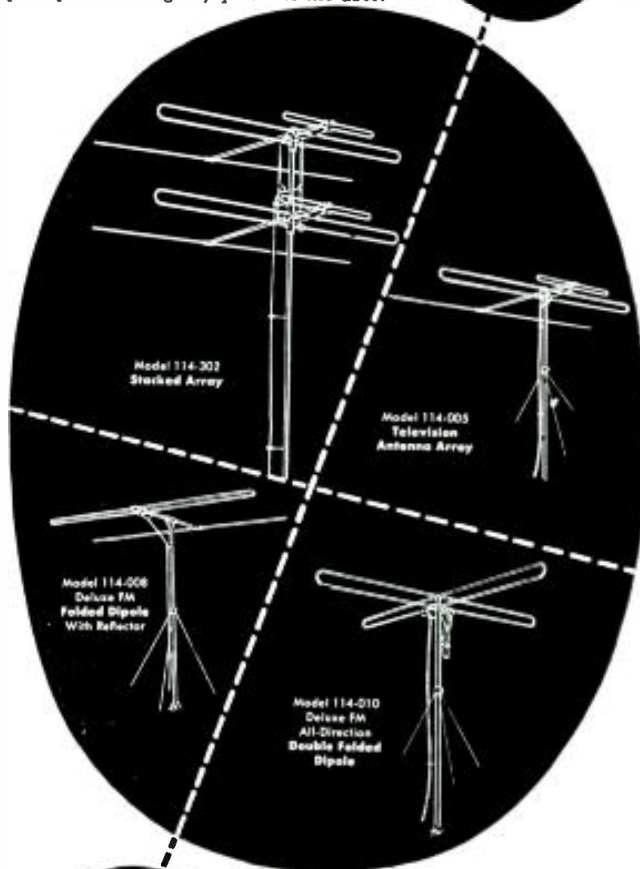

**FM**

Specifically engineered for finest FM performance, Amphenol FM antennas provide interference-free and general long distance reception which is unmatched in the FM antenna field. For rural, suburban or close-in installations, Amphenol FM antennas combine efficient operation with clean-cut, attractive design . . . antennas are entirely constructed of rust-proof aluminum. For consistent, top-quality service, Amphenol FM antennas are chosen again and again.

**AMPHENOL**

AMERICAN PHENOLIC CORPORATION

1830 SOUTH 54TH AVENUE  
CHICAGO 50, ILLINOIS

**NOW! BUILD 15 RADIOS \$14.75**  
COMPLETE KIT ONLY

**Absolutely No Knowledge of Radio Necessary. You Need No Additional Parts. The PROGRESSIVE RADIO KIT is the Only Complete Kit. Operates on 110-120 Volts AC/DC**

Contains everything you need, instruction book, metal chassis, tubes, condensers, resistors and all other necessary radio parts. The 36-page instruction book written by expert radio instructors and engineers teaches you to build radios in a professional manner. The circuits are designed to provide excellent performance. Altogether, fifteen circuits are constructed, including: 11 receivers, 1 audio amplifier and 3 transmitters. **SPECIAL OFFER—Electrical and Radio Tester sent absolutely FREE with each Progressive Radio Kit. Plus FREE Membership in the Progressive Radio Club. Entitles you to free expert advice and consultation service with licensed radio technicians. ORDER YOUR KIT NOW!**

**VACUUM TUBE VOLTMETER KIT**  
A professional piece of test equipment you need for FM and TV. Attractive steel case. FREE! Book on Advanced Servicing Techniques. **\$23.95**

**5" OSCILLOSCOPE KIT AM-FM TELEVISION**  
an absolute "must" for today's radio-man. Input Impedance: 1 Meg. and 50 Mmfd. Tubes—2-8J7, 2-5Y3, 1-8M3. 1-5B7P. FREE! Book on Cathode Ray Oscilloscope. **\$39.95**

**VOLT-OHM-MILLIAMMETER KIT**  
simple to construct, inexpensive but accurate. FREE! Book on Elementary Radio Servicing. **\$14.95**

**SIGNAL TRACER KIT**  
an invaluable aid in trouble-shooting. FREE! Book on Radio Test Instruments. **\$21.95**

**7"-10" TELEVISION KITS**  
Factory built and aligned 13 channel Tuner—13 Tube Kit. Complete set of tubes, including Cathode Ray Tube. **\$59.50**  
Factory built and aligned 13 channel Tuner, 10" Kit, less tubes. Complete set of tubes, including Cathode Ray Tube. **\$41.58**  
Factory built and aligned 13 channel Tuner, 10" Kit, less tubes. Complete set of tubes, including Cathode Ray Tube. **\$82.99**  
Cabinet for 7" or 10" **\$55.80**  
FREE! Television Servicing Notes **\$24.50**

**PROGRESSIVE AMPLIFIER KIT**  
High Fidelity Humless Amplifier complete with five tubes and ten selenium rectifiers. FREE! Book on Amplifiers. **\$16.00**

**TV SWEEP GENERATOR KIT \$28.95**  
150 Kc.-34 Mc., Four-tube Kit.

**SIGNAL GENERATOR KIT \$18.95**  
150 Kc.-34 Mc., Four-tube Kit.

**RF SIGNAL TRACER PROBE KIT \$5.50**  
20 cycle—200 Mc.—1N34 Xtal.

**ECONOMY AMPLIFIER KIT \$5.95**  
Simple to build, complete with five tubes. FREE! Book on Amplifiers.

**5 TUBE AC-DC SUPERHET KIT \$14.25**  
Complete with tubes and cabinet. FREE! Book on Building Receivers.

**6 TUBE AC-DC 2-BAND SUPERHET KIT \$17.45**  
Complete with tubes and cabinet. FREE! Book on Amateur Radio Building.

**7 TUBE AC-DC FM RECEIVER KIT \$29.95**  
Complete with tubes and cabinet. FREE! Television and FM Servicing Notes.

**4 TUBE SUPERHET PORTABLE KIT \$12.95**  
Complete with tubes and cabinet; less batteries. FREE! Book on Unusual Radio Circuits.

**AUTOMATIC BIKE RADIO**  
Can be mounted on a bicycle, or carried as a personal portable radio. Supplied with all bicycle mounting hardware and telescopic antenna. Antenna features "feather" less batteries. **\$17.47**

**AUTOMATIC CAR RADIO**  
6 tubes stereo. Three gang condenser. Fits all cars—easy installation—mounting brackets included. List Price \$39.95. **NOW ONLY \$27.97**  
Also 5 Tube Superhet Only **\$25.97**

Product 2% if full payment accompanies order. C.O.D. orders accepted in U.S.A. Write for further information concerning the above merchandise. Send for our FREE catalog.

**PROGRESSIVE ELECTRONICS CO.**  
Dept. RE-27 497 Union Avenue  
Brooklyn 27, New York

**A 60-WATT PA AMPLIFIER**

Described in *T.S.F. Pour Tous* (Paris), this public address amplifier has an average power output of 45 watts and delivers up to 60 watts on peaks. The power amplifier, a pair of 6L6's operating in class AB2 with fixed bias, is driven by a triode-connected 6F6. The speech-amplifier section consists of a 6N7 amplifier-mixer and a 6C5 voltage amplifier. Two power supplies are used. One delivers 300 volts at 60 ma to the plates of the 6N7, 6C5, and 6F6, and develops 25 volts bias for the 6L6's. The other supply delivers 400 volts at 250 ma to the plates and screens of the power-amplifier tubes.

The amplifier will work with a high-output microphone, but a preamplifier will probably be required with some PA

microphones. It is advisable to build the amplifier on one chassis and the power supplies on another to lessen the chances of hum pickup.

**MATERIAL FOR AMPLIFIERS**

**Resistors:** 1—650, 1—1,200, 2—4,700, 1—10,000, 1—20,000, 1—30,000, 2—470,000 ohms, 1/2 watt; 2—100 ohms, 1 watt; 1—400 ohms, 10 watts; 1—5,000, 1—20,000 ohms, 20 watts; 1—50,000, 2—500,000 ohms, audio-taper potentiometers.

**Capacitors:** 1—250 muf, mica; 3—.03, 5—.05 uf, 450 volts, paper; 4—20 uf, 50 volts, 2—8, 2—16 uf, 450 volts, electrolytic; 1—8 uf, 600 volts, paper or electrolytic.

**Transformers:** 1—power, 700 volts c.t., 60 ma, 6.3 volts at 2 amps, 5 volts at 2 amps; 1—power, 800 volts c.t., 250 ma, 6.3 volts at 3 amps, 5 volts at 3 amps; 1—output, 60 watts, 3,800 ohms plate-to-plate, multitap secondary; 1—driver, ratio of primary to 1/2 secondary 5:1, to match triode 6F6 to class AB2 6L6's. **Chokes:** 1—13 h, 65 ma; 1—8 h, 250 ma; 1—9 h, 50 ma, or standard a.c.-d.c. type.

**Miscellaneous:** 6—octal, 1—4-prong sockets; 1—s.p.s.t. toggle switch; 2—chassis; tie points, terminal strips, and assorted hardware.

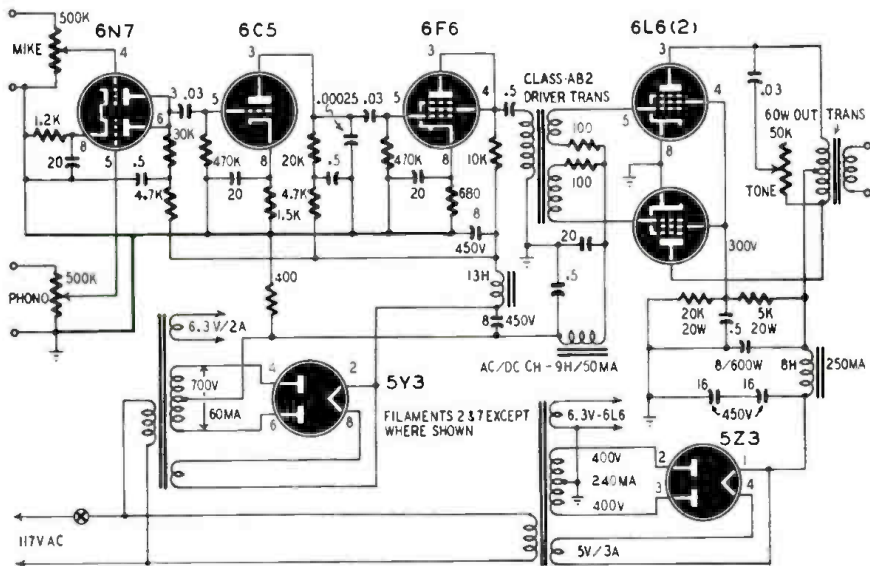

**BOOSTER AMPLIFIER**

Small radio sets are often used in workshops, garages, stores and other places where the noise level is high, making it impossible for anyone to hear the set unless they are very close to it. This booster amplifier, described in *T.S.F. Pour Tous* (Radio for All), Paris, France, can be connected across the output of the receiver to amplify the signal to about 10 watts and to feed it into a conveniently located auxiliary speaker.

The amplifier consists of a pair of push-pull, class-AB1 6V6's operated

with fixed bias. This bias is developed by a 6H6 in a novel circuit described in the April, 1949, issue of *Radio-Electronics*. A 51-ohm resistor in the cathode return of each 6V6 limits the plate and screen currents if the fixed bias fails.

The amplifier tubes are fed from a transformer designed to match a voice coil to push-pull grids. If a transformer of this type is not readily available, one designed to match a low-impedance microphone or pickup to push-pull grids can be used.

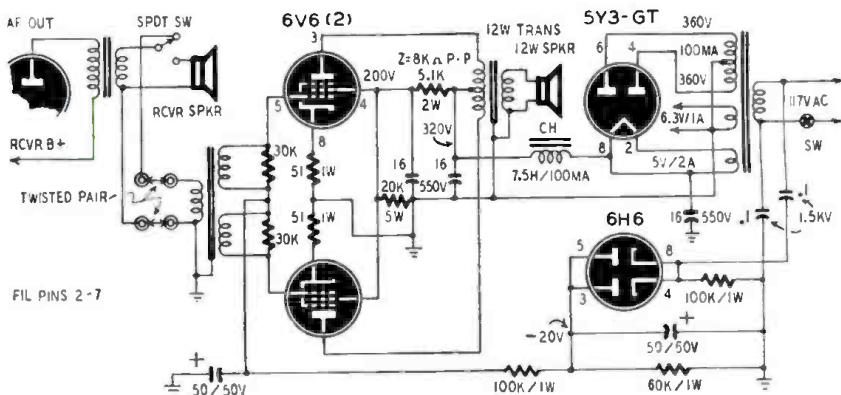

**PE-157 POWER SUPPLY**—Incomplete unit, but a "GOLD MINE" of relays, switches, jacks, selenium rect., etc. Hinged lid portable metal case (6"x8"x12"), crackle finish. P.L.'s 173a Tech. Manual. Shpg. wt. 20 lbs. ALL FOR ONLY **2.49**

**RADIO HARDWARE TREASURE**—A FULL POUND of Screws, Nuts, Washers, Lugs, etc. ALL IN HANDY SELF SEALING HINGED LID METAL CAN. Shpg. wt. 2 lbs. **49c**

**ANTENNA MAST SECTIONS**—M8-49, 50, 51, 53 or 54—ea. 39c; 5 for \$1.00. Shpg. wt. 2 lbs. ea.

**ALNICO MAGNETS**—NEW "EXPERIMENTAL KIT" of 14 assorted powerful Bar, C, U, Block Circular, etc. types **1.98**

**RM-4 RECORDING MOTOR (G.L.)**—115v. duty 110v. AC. Silent operating for WIRE TAPE or DISC RECORDING. FANS, DISPLAYS, etc. 3 1/2" x 4 1/2" x 2 1/2". Less turntable, mtg. plate & reduction drive wheel. SHDS. wt. 1/2 lbs. **4.95**  
YEAR'S BEST BUY AT

**WIRE RECORD-PLAYBACK HEAD**. Standard type. Precision built. TRIPLE COIL (second play-back case). 3 pin plug-in type. Molded bakelite housing (1 1/2" x 1 1/2" x 1 1/2"). accurately ground for max. fidelity. For replacement or new applications **6.95**

**WIRE HEAD MTG. SOCKET**. Polarized; shielded. .35

**HEARING AID AMPLIFIER ASSEMBLY**. Schenker vacuum tube type. MAKE A REAL VEST POCKET RADIO, adding mtg. frame, sec. & speaker or phone. Ready-wired miniature components include: 2 controls, output trans., dble. choke, switch, resistors, condensers, etc. COMPLETE WITH SCHEMATIC FOR BUILDING 2 or 3 TUBE SET!! Overall: 1 1/2" x 2 1/2" x 3 1/2". Weighs only 3 1/2 ozs. **2.49**

**HIGH FIDELITY CRYSTAL MICROPHONES!!** Made for world famous hearing aid mfr. Sensitive hi-impedance diaphragm type. Small size (1 1/4" O.D.). 1/2" deep. Ideal for REGULAR LABEL or CONTACT MIKE. Rubber shock-mtd. frame. Less housing. Lightweight aluminum housing. **98c** 15c

**110V. AC RELAY (W-L)** 8 P.S.T., norm. open, 20A contacts, 3 1/4" x 1 3/4" x 1 1/2". 3/8" bakelite base. SPECIAL!! **1.25**

Min. order \$2.00. 20% Deposit Req. on all C.O.D.'s. Please add sufficient postage—excess refunded.

**LEOTONE RADIO CO.** 67 Dey Street, New York 7, N. Y.

**EMC R. F. SIGNAL GENERATOR**



**MODEL 500 \$29.75**  
Model 500K (kit form) \$18.75

**READ THESE OUTSTANDING QUALITY FEATURES . . .**

- Employs electrostatically shielded transformer for 115V 60 cycle operation.
- ALL coils not in use are automatically shorted out.
- Provision for external modulation.
- Attractive 3 color panel.
- Covers range from 150KC to over 30 megacycles on fundamentals—over 100 megacycles on harmonics.
- 400 cycle internal modulation available.

Write for free catalog B-7

**EMC ELECTRONIC MEASUREMENTS CORP.** 423 Broome St., N. Y. 13, N. Y.

**MATCHING LOUDSPEAKERS**

Two novel methods of eliminating output transformers on amplifiers driving a number of speakers were described in *T.S.F. Pour Tous* (Paris). Fig. 1 shows how line-to-voice-coil transformers are connected so that the sum of their primary impedances equals the recommended plate load for the amplifier tube. The primary impedance of each transformer should equal the load impedance of the tube divided by the number of speakers if the power is to be distributed equally. For unequal distribution of power, the transformers may have different impedances. The power distribution varies directly as the impedance of the transformer.

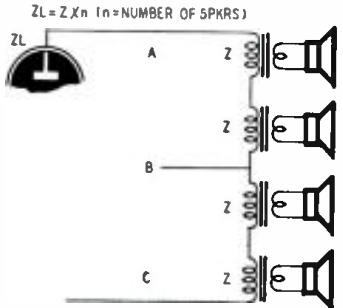

Fig. 1—Connections for four series speakers.

For single-ended amplifiers, connect C to B-plus and A to the plate of the tube. Connect B-plus to B and the tubes to A and C for push-pull amplifiers. Be sure that the impedances and d.c. resistances are equal on both sides of B.

Fig. 2 shows how high-impedance output transformers can be connected in parallel so the resultant impedance equals the plate-load impedance of the

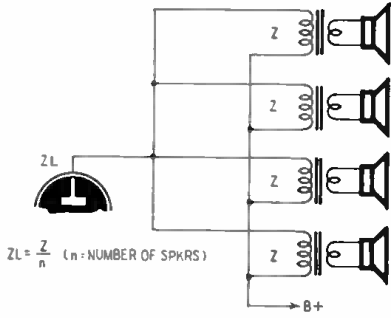

Fig. 2—Parallel arrangement matches output.

tube. In this case, the impedance of each transformer should equal the product of the plate-load impedance and the number of speakers. Different transformers can be used provided the resultant impedance approximates the load impedance for the amplifier tube.

**TEST LEAD REPAIR**

Sometimes a test lead breaks off the prod. To fix it, I file a slot in the thick part of the metal prod, pass the wire down the insulated handle and through the slot, then fill the slot with solder. After the excess solder is filed off and the surface of the prod smoothed with steel wool, the unit looks like new.  
VICTOR NEWTON, Jasper, Ohio



**Chassis**

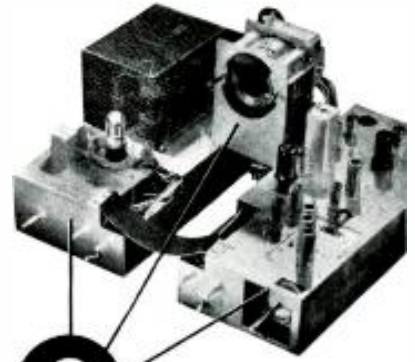

**3**

**UNIT DESIGN**

**FITS ANY CABINET**

The most versatile television chassis yet designed! Three basic units — power supply chassis, RF chassis and deflection yoke assembly — may be placed side by side, one above the other, etc., to conform to any cabinet. Simply plug in the cable connectors. Each unit is soundly engineered and built to famous National standards of performance.

1. Operates 10" or 12" picture tube.
2. Tunes all 12 channels.
3. Wired, pre-tuned and tested — not a kit.
4. RF stage employs tuned grid and plate for maximum gain and optimum band width.
5. Unique 36 mc IF minimizes interference.
6. Fine tuning control covers range of 2-3 mc. for maximum tuning accuracy.
7. Improved intercarrier sound.
8. Magnetic deflection and "fly-back" high voltage supply.
9. 72-ohm unbalanced and 300-ohm balanced inputs.
10. Supplied with two six-inch PM speakers.

**\$149.50**

(less picture tube)



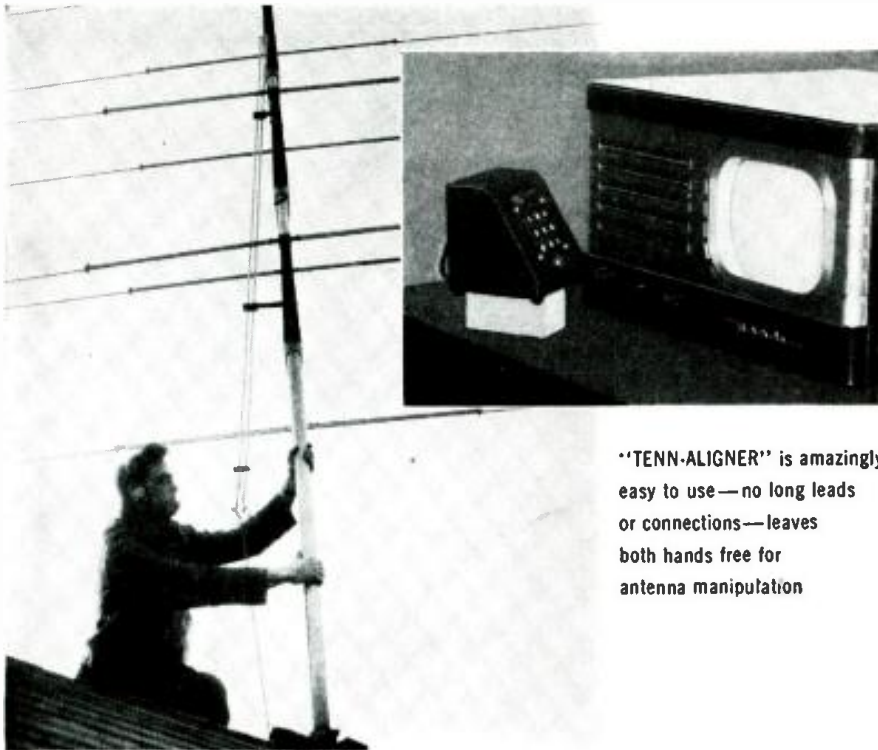

"TENN-ALIGNER" is amazingly easy to use — no long leads or connections — leaves both hands free for antenna manipulation

## One man TV installation now easy, quick, positive

THE NEW McMURDO SILVER "TENN-ALIGNER" works on the audio or video carrier, and makes it possible for one man to quickly and surely match and orientate even the most complicated antenna systems on all TV channels.

Simply place the cabinet pick-up unit near the receiver. Connect the antenna lead-in to the back plate terminals. Run a short piece of the same transmission line from the cabinet to the antenna terminals of the set. Switch the receiver to the desired channel, and tune in the test-tone, video carrier or music/speech being transmitted. No separate line is required between the set and roof positions, as the transmission line itself serves both as antenna lead-in, and dual communication link.

Clip the special headset across the transmission line connection at the antenna to actually hear the re-transmitted signal. This "upstairs" unit has been designed to allow full freedom of the hands at all times. Extra trips between roof and set are now unnecessary. Since the measurement is aural, the ratio of received signal to noise may be easily observed, and no misleading effects can exist.

See this amazing "TENN-ALIGNER" at your favorite jobber today. Model 914 complete for one man operation is only \$23.95 net.

Special lip mike and extra head set for two-way communication \$11.00 net.



When more than one man is on the installation the extra set of headphones plugs into the "downstairs" cabinet for two-way communications without the necessity of a separate transmission line.

Look to McMURDO SILVER for the NEWEST in TV Service Equipment

Send for Catalog  
See these and other  
McMurdo Silver  
LCETI instruments at  
your favorite jobber.

OVER 37 YEARS OF RADIO ENGINEERING ACHIEVEMENT

*McMurdo Silver Co., Inc.*  
EXECUTIVE OFFICES: 1240 MAIN ST., HARTFORD 3, CONN.  
FACTORY OFFICE: 1249 MAIN ST., HARTFORD 3, CONN.

### TWO-CHANNEL MIXER

? Please print a circuit of a miniature preamplifier-mixer for two channels. I want to use this unit between two microphones and the input terminal of my amplifier. Please include a volume control for each channel so I can use the control on the amplifier for the master gain control. Only moderate gain being required, triodes will probably work nicely.—G.D.D., Los Angeles, Calif.

A. Here is a twin-channel mixer that will supply additional gain to your amplifier. The controls should not be advanced to the point where the amplifier is overloaded. The unit can be con-

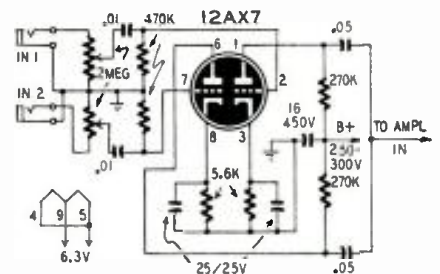

structed in a small shield can and mounted on the amplifier chassis or at the end of a flexible cable. The output lead should be shielded. Plate and heater voltages can be taken from the amplifier power supply.

Tube characteristics are not critical; other twin-triodes may be used.

### BROADCAST-STATION INTERFERENCE

? I live near a powerful broadcasting station and its signals blanket the shortwave bands of my BC-348. Is there any way that I can cure this interference?—G.B.F., Timmonsville, S. C.

A. The BC-348 is a well-shielded receiver; therefore the signals are probably coming in on your antenna. A pair of wavetraps mounted close to the antenna terminals of the set should eliminate the trouble. The diagram shows series- and parallel-tuned wavetraps. The coils may be standard antenna or r.f. coils tuned with 400- $\mu$ f padders. L1 and L3 are the windings normally connected to a grid, and L2 is a primary winding of the coil.

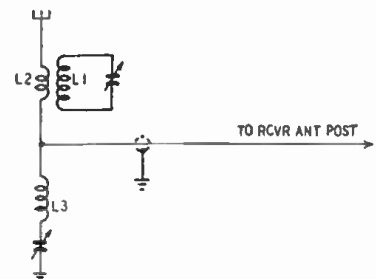

You may find that you are receiving a harmonic of the broadcast station. In this case, each trap should be tuned to the harmonic. Broadcast coils can be pruned to cover the shortwave bands.

RADIO-ELECTRONICS for



If the interference is the result of intermodulation—the signal is heard only on other carriers—the trouble may be caused by a bad tube in the r.f. stage of the set. Try a new tube before installing traps.

**AMPLIFIER DATA**

I have a diagram of a 15-watt a.f. amplifier using push-pull 2A3's, 6SN7 phase inverter, and two 6SJ7 speech amplifiers. The B-plus lead is marked 300 volts.

1. How much current must my filament transformer deliver?
2. How much current is drawn from the B-supply?
3. Please show pin connections for the tubes used in this amplifier.
4. What are the specifications for the output transformer?

Please answer these questions or tell me where to find the answers.—R.W., New York, N. Y.

A. Trying to construct a receiver, amplifier, or any other electronic device is a waste of time and effort if you don't have a tube manual. Answers to all your questions will be found in almost any tube manual.

1. Any filament winding feeding parallel filaments or heaters should be rated to carry the sum of the currents drawn by the tubes. Each 6SJ7 draws 0.3 ampere and the 6SN7 draws 0.6 ampere, making a total of 1.2 amperes. It is advisable to use a transformer with a 2-ampere, 6.3 volt winding if one is available. Each 2A3 draws 2.5 amperes at 2.5 volts; therefore, the transformer or winding for these tubes should be rated at 5 amperes or more. Because these tubes have directly heated cathodes, the filament winding should be center-tapped.

2. With 300 volts on their plates, 2A3's will draw as much as 147 ma. Maximum current for each 6SJ7 is about 4 ma, and 20 ma for the 6SN7. The power supply should be capable of delivering at least 175 ma at 362 volts, assuming that the fixed bias is developed across a resistor in the negative leg of the high-voltage power supply. If the bias is from a separate supply, then a 300-volt supply will do.

3. Tube-base diagrams and other technical information will be found in tube manuals, many of which retail for less than 50 cents.

4. The output transformer should be rated at 15 watts or more, and its windings should match a 3,000-ohm plate-to-plate load to the voice coil of your speaker. A universal output transformer will permit you to match your amplifier to almost any combination of speakers and lines.

A tube manual is to any man who does more with radio than twiddle dials what a Bible is to a minister. To be without one is to tie your hands behind you. Every bit of the information printed above was obtained by the simple expedient of opening a tube manual to the pages labeled with the numbers of the tubes in question and copying, without change, the information found there. Try it!

**CLEAR THE ROOFTOPS FOR...**

*Another Vertrod First!*

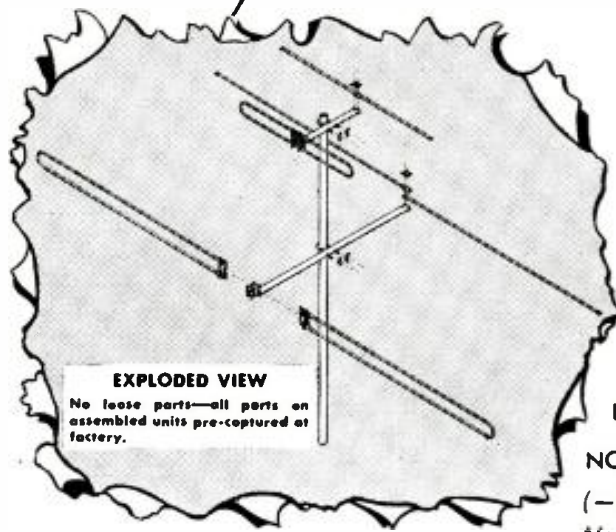

**EXPLODED VIEW**  
No loose parts—all parts on assembled units pre-captured at factory.

**SENSATIONAL "4'n 1" TV ANTENNA**

1. folded dipole
2. straight dipole
3. 72 ohm line
4. 300 ohm line

**ASSEMBLES IN RECORD TIME—**

**NO TOOLS REQUIRED!**

*(— that's right!*

*Not even a screwdriver!)*

**ALL IN ONE—SETS UP AS REQUIRED BY SIMPLE ADJUSTMENT OF JUMPER LINKS**

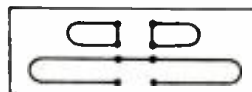

HF straight dipole  
LF folded dipole



HF and LF folded dipole

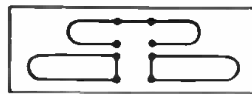

HF folded dipole  
LF straight dipole

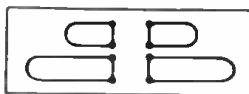

HF and LF straight dipole

- Plated steel lock-seam 1" dia. tubing. Models available with 5 and 10 foot masts. (Furnished with two mounting clamps.)
- All tubular elements of hard tempered aluminum.
- Bakelite insulators which are non-hygroscopic.
- No loose parts— all parts on assembled units pre captured at the factory.

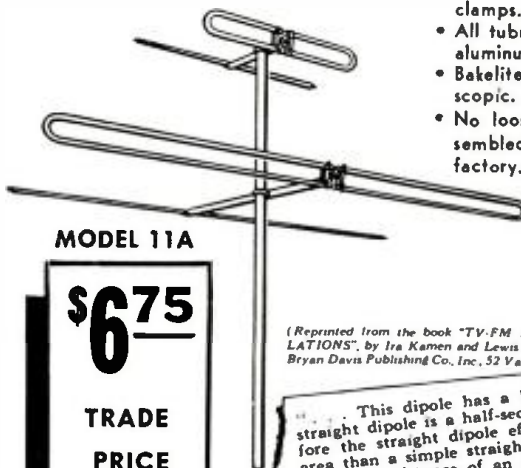

**MODEL 11A**

**\$6<sup>75</sup>**  
**TRADE PRICE**

**FROM CARTON TO ROOFTOP IT TAKES LESS TIME TO INSTALL A VERTROD "4 'n 1"**

(Reprinted from the book "TV-FM ANTENNA INSTALLATIONS", by Ira Kamen and Lewis Winner. Published by Bryan Davis Publishing Co., Inc., 52 Vanderbilt Ave., N. Y. C.)

This dipole has a broad-band characteristic since each straight dipole is a half-section of the folded dipole, and therefore the straight dipole effectively has a larger cross-sectional area than a simple straight tubular rod. It is a theoretical fact that the resistance of an antenna element increases more rapidly than its inductance as its cross-sectional area increases, and since Antenna Q = Inductance/Resistance it is apparent that a dipole made up of two half-sections of a folded dipole will have a relatively low Q characteristic and therefore a broad-band response.

MANUFACTURED BY



For information, contact your distributor or write direct.

**DISTRIBUTORS:** Exclusive franchises available in some territories. Write for details.

**11 PARK PLACE • NEW YORK 7, NEW YORK**

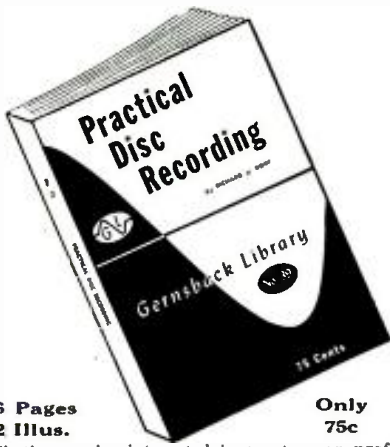

96 Pages  
82 Illus.

Only  
75c

Whether you're interested in amateur or professional recording, you'll find PRACTICAL DISC RECORDING by Richard H. Dorf invaluable. It not only tells you how to make successful records, but in addition each important recording component is given a full chapter, explaining its purpose, and what features to look for when buying. Without waste of words, it gets right down to business on the first page. It tells you what you need to make good records and how to do it by using any type equipment—from the simplest to the most expensive—depending on your purpose and pocketbook. You will find all the practical phases of recording covered as well as the underlying principles.

Here are other fine books which will give you valuable information:

**No. 29—HANDY KINKS and SHORT CUTS.** A carefully edited compilation of time savers. Kinks on Antennas—Power Supplies—Test Equipment—Servicing in the Shop—Phonographs and Amplifiers—Coils and Transformers. 50c.

**No. 30—UNUSUAL PATENTED CIRCUITS.** 1944-46. A gold mine of unusual circuits, many a result of wartime research. Control Circuits—Detectors and Amplifiers—Power Supplies—Miscellaneous Circuits—Foreign Circuits. 50c.

**No. 31—RADIO QUESTIONS AND ANSWERS.** Answers to most frequently asked questions. Clear circuit diagrams. Amplifiers—Receivers—Transmitters—Meters and Test Equipment—Interphones—Power Supplies—Phonograph Amplifiers—P. A. Systems. 50c.

**No. 32—ADVANCED SERVICE TECHNIQUE.** Visual Alignment—Tracking Problems—Negative Feedback—Tone Control Circuits—Adding Microphones to Sets—Matching Loudspeakers—Remote Juke Boxes—Servicing Record Changers—Hum Elimination—FM Servicing. 50c.

**No. 33—AMPLIFIER BUILDER'S GUIDE.** How to build amplifiers with power outputs ranging from 8 to 30 watts. Detailed design information on: Push-Pull—Phase Inversion—Bass and Treble Boosters—Volume Expanders—Resistance Coupling—Internal Feedback. 50c.

**No. 34—RADIO-ELECTRONIC CIRCUITS.** An extensive collection of circuit diagrams, with brief, to-the-point descriptions of each, including: Intercom Systems—Power Supplies—Balancing Circuits—V. T. Voltmeters—Amplifiers—Receivers—Phono Amplifiers—Short Wave Adaptors—Electronic Relays. 50c.

**No. 35—AMATEUR RADIO BUILDER'S GUIDE.** How to Build: A 2 Meter Set—Miniature Communications Receivers—Transmitters—A Pre-selector—A Rotary Beam Aerial—Power Supplies—and other ham gear. 50c.

**No. 36—RADIO TEST INSTRUMENTS.** Building: Signal Tracers—Capacity Meters—Portable and Bench Multi-checker—Signal Generators—Tube Checkers—Electronic Voltmeters—and many others. 50c.

**No. 37—ELEMENTARY RADIO SERVICING.** How to get started: Planning the Service Shop—Equipping the Shop—Systematic Circuit Checks—Signal Tracing Methods—Servicing the Midset—Soldering—Servicing Volume Controls—How to Service Speakers. 50c.

**No. 38—HOW TO BUILD RADIO RECEIVERS.** This book contains a sufficient variety of sets to appeal to every radio fan. Includes: Short-Wave, Broadcast, Portable, A. C. Operated, Miniature and Standard Receivers. Complete coil-winding data is furnished. 50c.

**No. 39—THE CATHODE-RAY OSCILLOSCOPE.** Gives a complete understanding of the working principles behind oscilloscope operation, and how to use the instrument effectively. Six complete chapters include information on the cathode ray tube, aligning TV, AM and FM sets, audio measurements, ham transmitter measurements and many other important subjects. 75c. See your radio parts jobber today or write direct to **RADCRAFT PUBLICATIONS, INC.** Dept. 79, 25 West Broadway, New York 7, N. Y.

**DIVERSITY A. G. C. SYSTEM**

Patent No. 2,459,259

Charles Percy Beanland, Chelmsford, England  
(assigned to Radio Corp. of America)

Diversity radio reception helps eliminate fading and interference. Several antennas are set up at different points to feed separate receivers, and the outputs are combined to form one signal. Some receivers may pick up little or no voltage, due to fading, but the signal remains audible because of pickup by the others.

A single a.g.c. system is preferable in order to maintain a constant level. Due to filtering required by each receiver, however, the time constant would be very large. This results in sluggish a.g.c. action.

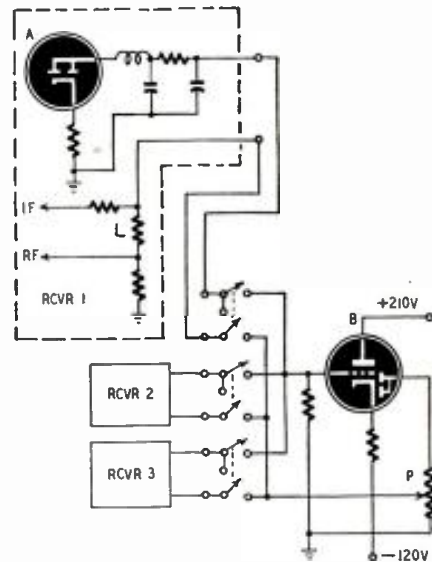

With this invention a single a.g.c. adjusts the total gain of all receivers. The figure shows three receivers, two of them in block form. A is the a.g.c. tube and L the load. When the three switches are in their down position, tube B is connected in the circuit and controls the gain of all receivers.

The voltage at the grid of tube B is due to the receiver developing the strongest signal. It causes a negative bias which reduces plate current and causes the cathode to become negative. Therefore, the diodes conduct. The negative potential at P is fed back through each double-pole switch to each a.g.c. load L. With this method, the receivers which pick up little signal are made less sensitive. This decreases the possibility of picking up noise and interference.

If desired, the three switches may be left in the up position. Tube B is disconnected from the remainder of the circuit and each pair of leads is shorted. In this case each receiver is controlled by its own a.g.c. system.

**VIDEO AMPLIFIER**

Patent No. 2,458,849

Russell J. Grambsch, Marshfield, Wis.

A video amplifier must faithfully reproduce abrupt as well as gradual changes in voltage. Long-time-constant, R-C circuits must be avoided. In this circuit direct coupling is used between stages, thus eliminating the usual coupling capacitance. The effect of the cathode R-C circuit is eliminated by an unusual feedback connection between the grid and plate of the second tube B.

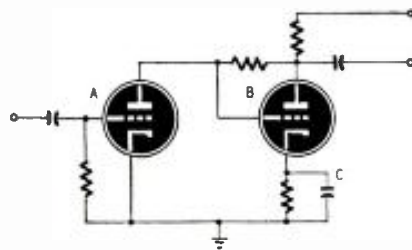

**OPPORTUNITY AD-LETS**

Advertisements in this section cost 25c a word for each insertion. Name, address and initials must be included at the above rate. Cash should accompany all classified advertisements unless placed by an accredited advertising agency. No advertisement for less than ten words accepted. Ten percent discount six issues, twenty percent for twelve issues. Objectable or misleading advertisements not accepted. Advertisements for August, 1949, issue, must reach us not later than June 21, 1949.  
**Radio-Electronics, 25 W. Broadway, New York 7, N. Y.**

**LANCASTER, ALLVINE & ROMMEL, 436 BROWN Building, Washington 5, D.C.** Registered Patent Attorneys. Practice before United States Patent Office. Validity and Infringement Investigations and Opinions. Booklet and form "Evidence of Concealment" forwarded upon request.

**AMATEUR RADIO LICENSES. COMPLETE THEORY** preparation for passing amateur radio examination. Home study and resident courses. American Radio Institute, 101 West 63rd St., New York City. See our ad on Page 78.

**TELEVISION, RADIO, TUBES, PARTS. SEND FOR** free bargain list. Hallmark, 592A Communipaw, Jersey City, New Jersey.

**WE REPAIR ALL TYPES OF ELECTRICAL INSTRUMENTS.** tube clerks and analyzers. Hazleton Instrument Co. (Electric Meter Laboratory), 140 Liberty Street, New York, N. Y. Telephone—Barelay 7-4239.

**21 VOLT AIRCRAFT BATTERIES. NEW 11 AMP. AT** 5 hr. rate. Dry charged \$14.70 ea. less 25% in lots of four. No C.O.D.'s please. Security Parachute Co., Oakland Airport, Oakland, Calif.

**BARGAINS: NEW and RECONDITIONED** Hallcrafters, National Collins, Hammarlund, Meisner, RME, other receivers, tuners, television receivers, transmitters, etc. Wholesale prices. Terms—Shipped on trial. Liberal trade-in allowance. Write: Henry Radio, Butler, Missouri and 1121n West Olympic, Los Angeles, California.

**HERMAN LEWIS GORDON, REGISTERED PATENT** Attorney, Patent Investigations and Opinions, Warner Building, Washington, D.C.

**12B8 & 25B8 TUBES. ADAPTER UNIT USING 2** miniature tubes (6AT6 & 6HA6 for 12B8, and 12AT6 & 12AB6 for 25B8). Takes less space than original tube—nothing else to buy—just plug in & it works. Money-back guarantee. 12B8 or 25B8 unit complete: \$2.49 each. In units for \$22.50. Send 25% deposit, balance C.O.D. Write for free parts catalog. COMMERCIAL RADIO, 36 Brattle St., Boston, Mass.

**ALUMINUM TUBING, ETC. BEAMS FOR AMATEURS.** TV, FM. Write for lists. Willard Radloff, Fostoria, Ohio

**27 Years experience radio repairing. Streamlined System.** No calculations. No formulas. Total price \$2.00 no-charge if C.O.D. Moneyback guarantee. Bass Radio, 11615 Grand river, Detroit 27, Mich.

**ELEMENT ONE REVISION COMPLETE. ELEMENT** Five and six, newly released questions only with answers for Radiotelegraph exams: \$1.00. A. A. McKenzie, 243 Polbar Ave., Hackensack, New Jersey.

**MAGAZINES (BACK DATES) FOREIGN, DOMESTIC** arts, Books, booklets, subscriptions, pin-ups, etc. Catalog, Inc. (retruded), Circone's, 863 First Ave., New York 17, N. Y.

**BARGAIN HUNTING: RADIO SERVICEMEN WRITE.** Sensational catalog. Henshaw Radio Supply, 3819 Troost, Kansas City 3, Missouri.

**RADIOMEN, SERVICEMEN, BEGINNERS—MAKE** more money, easily, quickly, \$250 weekly possible. We show you how. Information free. Merit Products, 216-321, 132nd Avenue, Springfield Gardens 13, New York.

**TELEPHONE DIALS. USED. AUTOMATIC ELECTRIC** AK-11 \$3.25. N-E Type-1 Rebuilt \$2.25. Readjusted \$1.25. All dials postpaid in U.S. Kissel Electric Products, 431-C Sherman, Gallon, Ohio.

**ONAN POWER PLANTS. 2500 WATTS. 120 V. 60** C.P.S. NEW, \$250. Kentucky Radio Kit Company, Box 35, C.T. Branch, Louisville 13, Ky.



WE ARE  
LOOKING  
FOR TUBES!

WHAT HAVE YOU GOT?

Interested in small or large quantities of all types of Transmitting, Industrial, and Receiving Tubes.

Send your list to:  
**MOHAWK ELECTRONICS CO.**  
160 GREENWICH ST., NEW YORK 6, N. Y.

RADIO-ELECTRONICS for

When a negative pulse appears at A, it is amplified. It appears at B as a positive pulse. C becomes charged, with the cathode side positive. C cannot discharge at once; therefore, the bias on the second tube remains.

With the circuit shown, the increased bias produces less plate current. Therefore, the plate voltage rises and causes the grid potential to rise also. This cancels out the negative bias due to the charged capacitance C, and conditions the amplifier for succeeding pulses.

**PHASE MODULATION**

Patent No. 2,459,557

George L. Usselman, Port Jefferson, N. Y.  
(assigned to Radio Corp. of America)

In this simplified PM system, two tubes are used in a modified Pierce oscillator circuit. Resonant circuit T is in series with the crystal, so it affects the frequency. Changes in the L or C components of this circuit cause slight variations in frequency, with negligible AM.

The plate circuit of one tube is tapped across the coil. The other is tapped across the capacitance. The screen grids are differentially modulated so that one plate resistance increases as the other decreases.

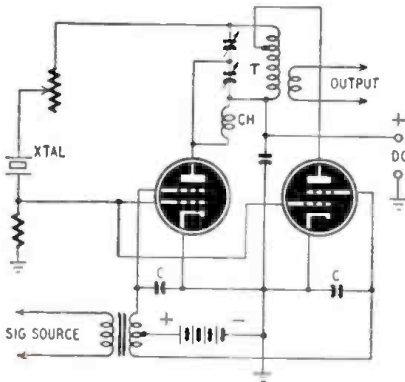

A partial shorting of the coil by the plate impedance reduces the effective L of the circuit. On the other hand, a partial shorting of the capacitance increases the effective C. Since the tubes are modulated differentially, L and C are decreased or increased together, and the circuit is tuned first in one direction and then the other.

Capacitors C bypass r.f. voltage but are small enough to have negligible effect at speech frequencies.



**25 WATT  
P.P. 6L6 HI GAIN  
AMPLIFIER KIT**

A wonderful buy! Make up an amplifier worth \$50 to you. Powerful enough for auditoriums seating 1500 people. Separately controlled Mike & Phono inputs. All parts, incl. drilled chassis, hardware, solder, circuit diagram, etc.

Lean tubes. Ship. wt. 12 lbs.

**PRICES NET F.O.B. OUR PLANT.**

**Universal/general corp.**  
365J Conal St., N. Y. 13; Walker 5-9642

**500 FORMULAS TO SUCCESS**

Many million dollar firms started with a single formula, for which they paid a big price. Here you have 500—no less—tried and tested formulas, recipes and processes for making things... all at the ridiculously low price of 25c.

Here is your opportunity to start a business with but a few dollars capital and with undreamed of profits in prospect. You can also use these formulas in your own home to cut household expenses to the bone. Or you can put them to use in your workshop to cut costs as much as 100%.

Quit paying out many dollars in profits to manufacturers, wholesalers and dealers, when you can make the same thing yourself for a few cents. It's so easy when you follow our simple instructions.

**66 PAGES, 47,000 WORDS IN TEXT**

Send for "500 FORMULAS AND RECIPES" today. Enclose 25c, that's all! You won't be asked for another cent now or later. Sold on a money-back guarantee.

**NATIONAL PLANS COMPANY**  
1968R Broadway, New York 23, N. Y.

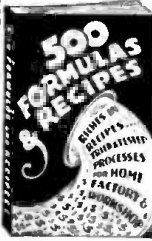

# DUAL RESPONSE

*Instantly Gives You High Fidelity or Rising Characteristic... as you want it!*

IT'S IN THE *Cardax*

.. the Only High Level Cardioid Crystal Microphone with All these Features!

- ★ EXCLUSIVE E-V DUAL FREQUENCY RESPONSE  
Convenient screw control provides:
  1. Smooth, Wide Range Response for High Fidelity Sound Pick-up.
  2. Wide Range with Rising Characteristic for extra crispness of speech or emphasis of high frequencies.
- ★ HIGH OUTPUT LEVEL
- ★ E V MECHANOPHASE\* CARDIOID  
Overcomes background noise, reverberation, feedback. Extends front pick-up range. Solves troublesome problems.
- ★ ENCLOSED METAL-SEAL CRYSTAL  
Greater Protection against Moisture
- ★ BUILT-IN "ON-OFF" SWITCH
- ★ HIGHEST PURITY PRESSURE CAST CASE
- ★ DURABLE SATIN CHROMIUM FINISH
- ★ TILTABLE HEAD. 5/8"-27 THREAD
- ★ BUILT-IN CABLE CONNECTOR

*Favorite of thousands for its quality, its performance, its value!*

**CARDAX Model 950. List Price... \$39.50**  
**CARDAX Model 950A. Made to match Collins 32V-1. Built-in control switch. MC-3 connector on free end of cable. List Price... \$42.50**

Send for Full Facts Today  
NO FINER CHOICE THAN

## Electro-Voice

**ELECTRO-VOICE, INC., BUCHANAN, MICH.**  
EXPORT: 13 East 40th St., New York 16, U. S. A.  
Cables: Arlab



E-V Pat. Pend. Licensed under Brush Patents.

WHERE TO BUY IT . . .

WHOLESALE RADIO

of Baltimore

In Kit Form! High Precision Vacuum Tube VOLTMETER

"EICO" Model 221 K \$23.95



15 different ranges, AC and DC ranges: 0 5/10/100/500 1000 volts. Electronic ohmmeter ranges from 2 ohms to 1000 megohms in 5 steps. Includes zero center for T.V. discriminator alignment. DC input impedance: 25 megohms. Double triode balanced bridge circuit assures stable performance. Steel case with etched panel, 110-130 V. a.c. 50-60 cycles. Size 9 1/2" x 6" x 5".

5" SCOPE In Kit Form. Model 400-K .....\$39.95

G.E. GERMANIUM DIODE IN48

- Welded Contact • Self Healing • Molded Plastic Case

Eliminates hum. 10,000 hrs. average life. Shown below in actual size. Write today for complete specifications. Now Only \$1.15



WHEELER Sound-Powered TELEPHONE HANDSET

No Batteries - No Power Supply Needed



Satisfactory operation up to 25 miles with #16 twisted wire; up to 19 miles with #19 twisted. High fidelity speech transmission. Perfect for stores, shops, homes, and installers of radio and television antennas. Order model SPT-102. \$8.75 each

\$17.50 per set of two.

Brand New, 2,000 Ohm "Utah" HEADPHONES

Type H.S. 16 A 2000 Ohms impedance. Canvas web handband. Long, standard type cord.

\$1.95



P.M. REPLACEMENT SPEAKERS

AT OUR LOW PRICES



SPECIAL 2" x 3" P.M. .79c ALNICO V 4" P.M. \$1.59 5" P.M. \$1.59 6" P.M. \$1.95

BEST 10" SPEAKER BUY \$3.29 2.15 oz. ALNICO "V"

0-300 MILLIAMETER

Brand new. Standard 2 1/2" round meter in aluminum case with cable and P1.55 plug. \$1.95

Sam's "Photofact TELEVISION COURSE"

Covers every phase of television. Gives you the ground work you must know to become a successful T.V. service technician. Over 200 pages. \$3.00

Converts Electric Drill Into Powerful Hammer

"POW'R-HAM'R" \$9.50

A highly efficient adaptor tool for drilling into cement, stone, or brick for installations. Complete with two holders. Price is net less drill and bit.

1/4" Bit .....\$0.60 1/2" Bit .....\$1.53

WRITE DEPT. QR-81 TODAY FOR OUR FREE MONTHLY "FYI" BULLETIN Phone MULberry 2134

WHOLESALE RADIO PARTS CO., Inc. 311 W. Baltimore St. BALTIMORE 1, MD.

SOUND-POWERED TELEPHONE

The sound-powered telephones used by the Armed Forces during the war were specially made to be very efficient, but anyone can rig up a sound-powered telephone system with two pairs of ordinary, good-quality, high-impedance headsets. Results are excellent up to 500 feet.

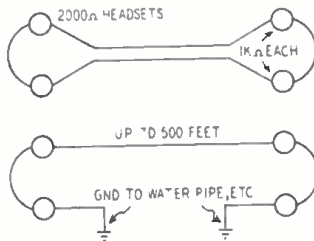

Each set of phones should have at least 2,000 ohms impedance. Simply connect them together, either with two-conductor cable or by using a single conductor plus a good ground on each end. If one set of phones is spoken into, the sound will be heard in the other pair.

WILLIAM E. JOHNSON, Detroit, Mich.

INSULATING TOOL HANDLES

I accidentally discovered that vinylite or Genflex plastic tubing swells when wet with G-C service solvent. When the solvent evaporates, the tubing returns to its original shape and size. I use this characteristic in insulating the handles of some of my tools.

Immerse a piece of 1/4- or 3/16-inch tubing in solvent for a few minutes; then remove it and slip it over the handles of your pliers, wire cutters, or other tools. When the solvent evaporates, the tubing shrinks, making a smooth professional-type insulation for the tool. Smaller tubing can be used on screwdrivers.

F. CASTREE, Rockford, Ill.

(At least one manufacturer makes tubing especially for this purpose, applied in exactly this manner.—Editor)

LP PICKUPS FOR OLD SETS

Some old receivers using plate detectors do not have sufficient gain in the a.f. section to provide sufficient output from LP pickups. Such sets will provide enough gain if the detector circuit is modified as shown in the dia-

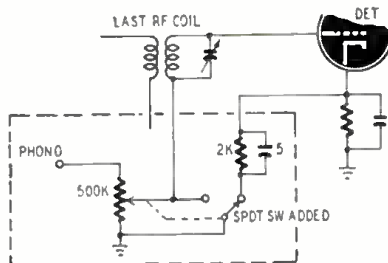

gram. The components enclosed in broken lines can be added to the circuit with very little trouble.

J. G. DODD, Chicago, Ill.

You Can't Match these MID-AMERICA Values!

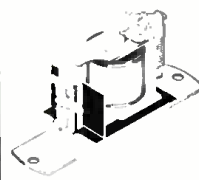
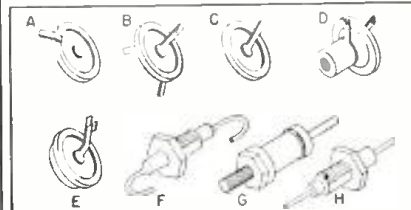

Plate Load RELAY

1000 ohm coil, SPST normally open contacts. EXTRA sensitive and used for many applications. 1 1/2" high, 1 1/4" wide, on 1 1/2" mt. pins. MA 1903 ..... \$1.19

Silver Mica Button Condensers



\$7.50 per 100 (all one type)

Table listing various capacitor models and values: MA-2536 (4) 20 muf, MA-2501 (10) 50 muf, MA-3531 (2) 55 muf, MA-3503 (A) 75 muf, MA-3532 (10) 75 muf, MA-3504 (A) 200 muf, MA-3539 (15) 250 muf, MA-3505 (C) 300 muf, MA-3509 (A) 500 muf, MA-3506 (B) 500 muf, MA-3510 (C) 500 muf, MA-3502 (D) 500 muf, MA-3507 (E) 500 muf, MA-3518 (A) 2000 muf

#18 2-conductor Wire & Drum

Used for running 110-volt AC lines, extension stock, etc. Full 17 1/2 feet of highest quality wire with tough, weather-resistant insulation. Complete with handy drum for spooling wire for storage. Limited quantities ..... \$2.39

BRAND NEW METERS

Dejor Model 310 meter for all ammeter and test applications. 10 ma. DC basic movement. 3 1/2" diameter. 2 3/4" body, 1 1/2" deep. Stock on these while they last. MA-2036 ..... \$1.95 each



Iron Core FM and AM IF TRANSFORMERS

Highly efficient for best construction and replacement. III IF adjustable iron cores provide high selectivity and gain. Only 2 1/2" x 1 1/2" square; spade lug mounting. MA-2296 10.7 Mc IF Transformer 49c ea. MA-2039 155 Kc IF Transformer 35c ea.

INTERCOM TRANSFORMER SET

One transformer to match voice coil to grid, another to 50L6 and similar output tubes. Both of these fine units PLIF's a momentary LPDT spring return push-button switch for less than value of one transformer alone! These are small, snap-mounting transformers. ONLY 98c FOR ALL THREE UNITS!

GRILLE CLOTH

Never before at our low price! Highest quality, golden tone grille cloth, styled to harmonize with all cabinet designs. Generates 50" width. \$1.79 per yard

This Month's Specials!

Table listing special offers: T-17 Microphone and plug; used; good 79c, 25 mil. min. size RF choke; 100 MA DU 19c, 25 mil. butterfly condenser 32c, 50 mf butterfly condenser 32c, Mercury switch; flexible 18" leads 29c, Brand new RC-306 Jack Box 19c, SPDT Slide Switch; black bakelite knob 15c

ORDER FROM THIS AD!

Send 25% deposit with order. Pay balance plus postage on delivery. Get your name on Mid-America's select mailing list and get first crack at latest, greatest values in radio parts, electronic equipment, tubes, etc. Send orders to Desk RC-79. Minimum order \$2.50.

MID-AMERICA CO. Inc.

STORE 2412 S. Michigan Ave. Chicago 16, Ill. WAREHOUSE 2307 S. Archer Ave. Chicago 16, Ill.

**HANDY SOLDERING TOOL**

When rewiring or repairing an electrical circuit, we frequently find that the holes in soldering lugs and socket terminals are filled with solder. Normal procedure for removing the solder is to apply heat and probe around the hole with an awl, piece of wire, or practically anything else that happens to be handy. In too many instances, the in-



strument selected is not long enough or is not shaped correctly for the job at hand. The little tool shown was developed especially for removing excess solder, but it is also very handy for removing wires that are wrapped tightly around a terminal or lug.

This tool was made from a 6-inch length of 3/8-inch steel rod ground or filed to a sharp point on each end. The points begin to taper about 1 inch from the ends. One end of the rod is bent until its tip is at a right angle to the length of the tool.

BEN GROSSMAN,  
New York, N. Y.

**MODIFYING T-17'S**

Surplus T-17 microphones will reproduce speech more clearly if additional small holes are drilled in the cap covering the diaphragm. Be sure to remove the cover before drilling it to avoid damaging the diaphragm. Further improvement can be made by carefully removing the cloth protective cover from the diaphragm and removing the capacitor connected across the mike on the rear.

L. E. KLINGBERG,  
Inglewood, Calif.

(Talking across the face of the mike rather than right into it will improve speech quality, too, and subdue the sounds of breathing usually heard when a close-talking mike is used.—Editor)

**\$3.00 FOR CARTOON IDEAS**

RADIO-ELECTRONICS prints radio cartoons every month. Readers are invited to contribute humorous radio ideas which can be used in cartoon form. It is not necessary that you draw a sketch, unless you wish.

**ALL THESE TUBES ARE NEW—  
UNBRANDED—FULLY GUARANTEED**

IR5	354	6BA6	<b>29¢</b> each
IT4	6AH6	12AU6	
IU4	6AU6	35W4	

**WHITE BLANK TUBE CARTONS**

100—SMALL PEANUT, 1"x1"x2 1/8"	\$.75
100—LARGE PEANUT, 1"x1"x2 3/4"	.85
100—GT TYPE, 1 1/4"x1 1/4"x3 3/8"	.95
100—SMALL G, 1 1/2"x1 1/2"x4 1/2"	1.25
100—LARGE G, 2"x2"x5"	1.45

**BROOKS RADIO DIST. CORP.**  
80 VESEY ST., DEPT. A, NEW YORK 7, N. Y.

JULY, 1949

Quality **TRANSVISION** Precision  
Engineered **TELEVISION INSTRUMENTS** Manufactured

**EQUIPMENT AND COMPONENTS**

For Better TV Performance and Lower Installation Costs

**Eliminate the Variables in Television Installation with  
the Transvision FIELD STRENGTH METER**

**Improves Installations! ! Saves 1/2 the Work! !**

Has numerous features and advantages, including—(1) Measures actual picture signal strength . . . (2) Permits actual picture signal measurements without the use of a complete television set.



(3) Antenna orientation can be done exactly . . . (4) Measures losses or gain of various antenna and lead-in combinations . . . (5) Useful for checking receiver re-radiation (local oscillator) . . . (6) 12 CHANNEL SELECTOR . . . (7) Amplitudes of interfering signals can be checked . . . (8) Weighs only 5 lbs. . . . (9) Individually calibrated . . . (10) Housed in attractive metal carrying case . . . (11) Initial cost of this unit is covered after only 3 or 4 installations . . . (12) Operates on 110V, 60 Cycles, AC.

Model FSM-1, complete with tubes Net \$79.50

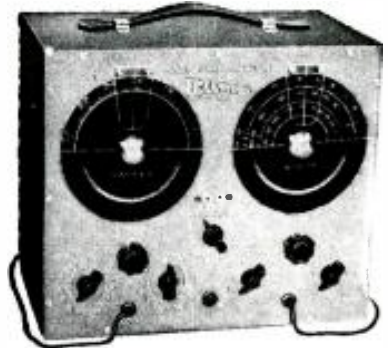

**TRANSVISION  
TELEVISION and FM  
SWEEP SIGNAL GENERATOR**

Complete frequency coverage from 0-227 MC with no band switching . . . Sweep width from 0-12 MC completely variable. . . Accurately calibrated built-in marker generator.

Model SG Net \$79.50

**TRANSVISION ALL-CHANNEL  
TELEVISION BOOSTER  
CONTINUOUS TUNING**



Model B-1 . . . List \$32.50

**TRANSVISION IS NOW  
EXCLUSIVE DISTRIBUTOR OF  
DU MONT TV/FM  
INPUTUNER**

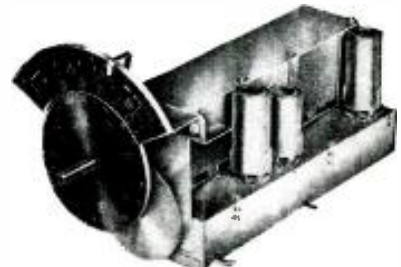

Model IT-1, with tubes . . . List \$59.95

All Transvision Prices are fair traded; subject to change without notice. Prices 5% higher west of the Mississippi.

**TRANSVISION, INC. Dept. RE. NEW ROCHELLE, N.Y.**

Please ship the following Transvision Products THROUGH YOUR NEAREST LOCAL OUTLET

RE-7

I am enclosing 10% DEPOSIT in the amount of \_\_\_\_\_ balance C.O.D.  
( ) I want to get into the Television Business. SEND ME DETAILS OF YOUR DEALER PLAN.

Name \_\_\_\_\_ City and Zone \_\_\_\_\_

(please print)

Address \_\_\_\_\_ State \_\_\_\_\_

## TELEVISION PARTS!!

Our new catalog lists hundreds of new television items; sets, parts and accessories at unbelievably low prices. Write today—it's free!

### TELEVISION TRANSFORMER

Pri. 115 Volts 60 Cycles Sec. 2500 Volts @ 2 ma.: 6.3 Volts @ .6A.: 2.5 Volts @ 1.75A  
Small size—brand new **PRICE \$3.85**

### MODEL NFRD—RADIO NOISE FILTER

**if it doesn't work, send it back!!**

We absolutely guarantee that our Model NFRD will eliminate all line noises when properly connected to radios, television sets, short wave sets, motors, electric shavers, refrigerators, vibrators, oil burners, transmitters, and all other sources of interference. This unit will carry up to 12 amperes or 1¼ KW of power and may be used right at the source of interference or at the radio.

Small size only 3"x1½"x7½". **\$1.95**  
Very low price only **EACH**

### Pre-Aligned TELEVISION KIT

Similar to Famous RCA 630TS and 830TS Circuits. Complete 12 Channel Tuning. 30 RCA Tubes, including rectifiers and Video. New, improved daylight viewing.

Built-in power for picture tubes, up to 16 inches. PM speaker with Choke (Better tone and volume—no hum). Special mounting bracket for 16" tube available. Simplified step-by-step instructions. 6 Full scale lithographed blueprints. All hardware and wire supplied. Exceptional Long Range reception. All components mounted to chassis.

**\$168.50**

less PICTURE TUBE

—TV cabinet to match ..... \$42.50  
—Bracket to mount 12" tube ..... .75  
—Bracket to mount 15" or 16" tube ..... 3.00

### DUAL SPEED A.C.-D.C. PORTABLE RECORD PLAYERS

Manufactured for U.S. Government. Used, but fully reconditioned. Dual-speed type. 33½ and 78 r.p.m. with fully adjustable speed control. Will operate on 110 v. A.C. or D.C. Cabinets are solidly constructed for portable use and are leatherette covered. Complete with dynamic speaker, built-in pickup, and amplifier. Ready to play. Price ridiculously low, at only **\$16.95**

### INTERCOMMUNICATION SYSTEM

A low priced system for executives, professionals or home use. Consists of a master station and one remote. Simple to operate, simple installation. Neat, rugged, beautifully finished wood cabiner, will fit anywhere. Complete with tubes—ready to operate. Ideal for use as Radio Baby Nurse. **Price \$10.95**

### SPECIAL! SPECIAL!

Mammoth assortment of radio and electronic parts, not less than TEN POUNDS of such items as transformers, chokes, condensers, resistors, switches, coils, wire, hardware, etc. A superbuy for experimenters, servicemen, and amateurs for only **\$1.25**

Satisfaction guaranteed on all merchandise.  
All prices F.O.B. New York City  
WRITE FOR FREE CATALOGUE T7

**RADIO DEALERS SUPPLY CO.**

154 Greenwich St. New York 6, N. Y.

## PROBE SHOOTS AROUND CORNERS

After wearing out my temper trying to touch with standard test probes various parts in a jammed-full receiver chassis, I removed the phonograph needles from the probes and substituted 2-inch lengths of No. 16 enameled wire. The ends, scraped clean, will contact any component in the receiver when the wire is bent to the correct shape. Where high voltages are present, the same scheme can be used, but the wire should be covered with spaghetti.

G. P. BRUNTON,  
Kingston, Ont.

## SPEAKER CONE REPAIRS

To repair a tear in a speaker cone, apply a small amount of household cement to the edges of the tear, bring the torn edges together carefully, then apply a cigarette paper over the tear on the back of the cone. When the cement has dried, the paper may be torn off, thus leaving a neat repair. Because this method adds a minimum of extra material to the cone, the fidelity of the speaker is not affected appreciably.

K. R. KNOWTON,  
Toronto, Ont.

## SCOPE TEST LEAD

A 36-inch length of co-axial antenna lead-in of the type used on automobile radios has four advantages as an oscilloscope test lead: (1) The shield prevents the hot lead from picking up stray a.c. and unwanted signals. (2) It is a low-capacitance cable, thus reducing losses when testing FM and TV circuits. (3) Some cables are fitted with phone tips that fit the jacks in combination alligator clips, thus providing a temporary connection that leaves the hands free for making adjustments on the circuit under test. (4) The 36-inch leads are just the right length for most ordinary servicing needs.

NORMAN H. KENT,  
Moose Jaw, Sask.

## TESTING VOLTAGE DIVIDERS

When checking a power supply which has a tapped bleeder, it is not necessary to check the voltage on all the taps. This is possible because the voltage drop at any tap on the bleeder is determined by the current drawn by the load through the various taps and by the bleeder current. This method is not a sure-fire check for resistors with adjustable taps since one or more of the taps not tested may be out of adjustment.

CHARLES ERWIN COHN,  
Chicago, Ill.

(This method of checking will not work in all cases. If one section of the bleeder—the bottom end, for example—is much smaller than the whole, then it is possible for the small section to short without altering the other values more than 5 or 10%. Errors of this magnitude are usually discounted in radio servicing.—Editor)



## SERVICE Television AND RADIO WITH THIS MODERN SERVICE UNIT

TELEVISION and FM radio present unlimited opportunity for service PROFIT . . . Your profits and service require the best equipment . . . SER-V-LUX.

\*Custom built instruments available for all types of service . . . unit can be supplied with blank panel. Write for bulletin D



**SERVELUX**  
MANUFACTURING CO.  
39th and Buchanan Aves.  
GRAND RAPIDS, MICH.

## WAR SURPLUS BARGAINS

### GIGANTIC MAIL SALE!

- ELECTRONICS
- RADIO
- ELECTRICAL APPARATUS

Sale ends midnight July 31st

Amazing values. Opportunity for home experimenters, laboratories, schools, etc., to get fine new, or new condition guaranteed equipment at fraction of original cost. We pay freight or postage. Typical items are listed below.

	Sale Price
• 3000-watt, 115-volt, 60-c Power Plants	\$299.50
• Wheatstone Bridges (0 to 11, 110 ohms.)	59.50
• Weston Air Port Photo-Light Control Units	29.90
• Weston Model 689-1F Industrial Ohmmeter and case	12.90
• W.E. Desk or Wall C.B. Telephones and ringer (complete)	4.99
• RCA (5", 3" and 2") Cathode Ray Tubes	3.55
• RCA Light, burglar alarm kit. Consists of rectifier, photo cell, thyatron, relay, sockets, etc.	4.43
• Drill press 31" polishing—grinding shaft and stone	1.29
• Burglar Alarm Units—Protect home and business	6.99
• High Pressure Steel Bottles (1800 lb.)	5.69
• Chromalux Heating Elements (24" — 800-W)	2.19
• Selsyn Motors—Cost Gov't. \$90—110 V —60-C. Pair	4.99
• DeLuxe, Outstanding Electrical-Radio Home Lab Kit—80 pieces	6.77
• Carbon Pile Regulator. Dozens of uses	.99
• Miniature Multi-Station Telephone. Secret Line. A four star value. Pair	7.89

Order from ad or send card for bargain laboratory, experimenter and amateur catalog. Satisfaction guaranteed. Our reference—National Bank of Commerce.

**LECO ENGINEERING CO.**

BOX 908 RE-5 LINCOLN, NEBRASKA

RADIO-ELECTRONICS for

WITH THE ASSOCIATIONS

THE annual meeting of the Empire State Federation of Electronic Technicians Associations (ESFETA) was held in Binghamton, N. Y., on April 24. Delegates from Rochester, Endicott, Corning, Ithaca, Binghamton, Poughkeepsie, New York City, and Long Island (East Williston) were present. There were also many visitors, chiefly from Rochester and Binghamton, though at least one—Richard Devaney, of the Philadelphia Radio Servicemen's Association—came from another state.

Two draft constitutions were discussed, and the Constitutional Committee was instructed to combine their best points and present the result to a future meeting of the Federation.

New officers elected for 1949 are: Max Leibowitz (Associated Radio-Television Servicemen of New York City), president; Margaret Snyder (Radio Technicians Guild, Rochester), vice-president; Wayne Shaw (Radio Servicemen's Association of Binghamton), secretary; Ben de Young (Central New York Radio Technicians Guild), treasurer; and A. J. Blakely (Corning Radio Television Servicemen's Association), Sergeant-at-Arms. Mr. Shaw and Mr. Young were re-elected to posts they had held since the organization of the Federation last year. T. Lawrence Raymo, 1948 president of the Federation, was renominated for the office, but declined.

A tentative program of educational meetings was read by Sam Marshall, program director of the Federation. It would provide for a series of 12 meetings in each of three areas (north, central, and south) into which the state would be divided for the purpose of the meetings. The program was accepted and liaison committees elected to expedite it.

The Radio-Television Servicemen's Association of Corning, N. Y., has held several informal meetings, A. J. Blakely told the annual meeting of ESFETA. It is at present engaged in drawing up a set of by-laws as a help to formal organization.

A. J. Blakely and Warren Fribley were elected delegates to the ESFETA meeting and were instructed to submit the organization's name as an applicant for membership in the State Federation.

The Long Island Chapter of the old Radio Servicemen's Association of America, reorganized after a long period of inactivity, sent John A. Wheaton as representative to the annual meeting of ESFETA. It was agreed to base further activity on the report from that meeting, and to hold further meetings on the last Wednesday of every month.

The Endicott (New York) Radio and Television Association reports that 17 of the 18 radio technicians in the area have joined the organization. President is Richard Wheat, and secretary is Richard Newcomb. Meetings are being held on the second and fourth Wednesdays of every month. Kenneth Brennerman and Dick Newcomb are the delegates to ESFETA.

(Continued on following page)

# 4 ALL-METAL KITS

meet every service need

Streamline your shop and sharpen your service with these attractive IRC All-Metal Kits and Cabinets.

New All-Metal Resist-O-Kit is the latest addition to IRC's family of popular METAL kits. Small, flat size makes it ideal for service calls. Choice of 2 assortments—45 half watt, or 30 one watt resistors in popular ranges.

IRC Resist-O-Cabinets are again available in heavy-gauge metal. Large and sturdy, these All-Metal cabinets are supplied in 3 assortments—83 one watt, 100 half watt, or a combination assortment of 92 half, one and two watt insulated resistors and new close tolerance PRECISTORS—all carefully selected ranges. Four "non-spill" drawers and 28 compartments.

All-Metal IRC Volume Control Cabinet is a long time favorite in modern service shops. Stock of 18 Interchangeable Fixed Shaft Controls plus switches and special shafts handles over 95% of all listings in the Industry Red Book. 20 compartments and 3 handy drawers.

For all of your daily resistor requirements (from 1/2 watts to heavy duty power wire wounds) IRC offers the All-Metal Basic Kit. Wide variety of selected values makes this your basic resistor stock. International Resistance Co., 401 N. Broad St., Phila. 8, Pa. In Canada: International Resistance Co., Ltd., Toronto, Licensee.



NEW RESIST-O-KIT

Flat, all-metal 1 1/4" x 3 3/8" x 6 5/8" 1/2 and 1 watt assortments.



ALL-METAL RESIST-O-CABINET

choice of 3 resistor assortments, 4 drawers, 28 compartments.



VOLUME CONTROL CABINET

all-metal, handles 95% of all listings in Industry Red Book.



ALL-METAL BASIC KIT

basic resistor stock, ideal for new service shops.

INTERNATIONAL RESISTANCE CO.

Wherever the Circuit Says ~~~



IRC ALL-METAL KITS ARE FURNISHED AT NO EXTRA CHARGE—YOU PAY ONLY THE REGULAR PRICE OF THE MERCHANDISE.

## HOW TO GET THE MOST

from only

# BASIC TEST EQUIPMENT

### Servicing by Signal Substitution

The Simple, Modern, Dynamic Speed approach to receiver alignment and adjustment problems, FM-AM-TV.

- Nothing complex to learn
- No extra equipment to purchase
- Universal — non-obsolete
- Employs only Basic Test Equipment

**S-S-S** tells HOW — in simple, direct language.

New 9th edition now off the press. 100 pages of valuable information.

Available from all leading radio parts and equipment distributors or directly from factory at only 40c per copy.

PRECISION APPARATUS COMPANY, Inc. • 92-27 Horace Harding Blvd., Elmhurst 4, N. Y.

# PRICES TALK at RADIO SUPPLY



## OZ 4's (No Limit)

Fresh RK and RCA. Standard commercial grade, not JAN's.

BUY 12 **58c**  
get 1 free EACH

EGG CRATE OF 100 **\$49.00**

## VIBRATORS

MALLORY universal standard 4 prong, non-synchronous. Can size 1 1/2" x 3 1/8".

**\$1.29**  
EACH

BUY 12 get 1 free

EGG CRATE **\$109.00**  
of 100



## AERIALS RADIART 363U1 (discontinued model) 3 section

63" top cowl, universal mount, 48" lead. Former list \$6.75.

**\$2.41**  
EACH

BUY 10 get 1 free

**\$215.00** per 100



## GENERATOR CONDENSERS



By one of the big 3

**15c** .5 mfd 200  
EACH VDC, 6" lead

BUY 12 get one free **\$12.00** per 100

## ORDER INSTRUCTIONS

Minimum order — \$2.00. 25% deposit with order required for all C.O.D. shipments. Be sure to include sufficient postage—excess will be refunded. Orders received without postage will be shipped express collect. All prices F.O.B. Detroit.



Demand This Seal of Quality

**DON'T WAIT — ORDER TODAY**

## GOVERNMENT SURPLUS! WORLD'S LOWEST PRICE

### PHOTO FLASH EQUIPMENT



COMES COMPLETE WITH 4 EDGERTON FLASH TUBES & REFLECTORS

EASY TO CONVERT INTO A 2-WAY PHOTO FLASH UNIT

OPERATES ON 110V. AC & 12V. BATTERY  
Brand new at a fraction of original cost. Contains finest component parts available. All necessary parts and complete instructions included. After conversion, works on 110V AC or 12V battery by a flick of a switch.

**\$68.**

Immediate delivery on all mail orders  
CINEX, INC., 165 W. 46th St., N. Y. 19, N. Y., Dept. AEZ

## R. S. E. 3 inch TELEVISION SCOPE

### Features:

- WIDE BAND VERTICAL RESPONSE
- FLAT TO 750kc
- DOWN 3db AT 1mc
- VOLTAGE GAIN OF 20 AT 5mc



AR-3

The R.S.E., AR-3 Scope has been built by Ross Armstrong to our rigid specifications. It's a complete unit that embodies standard horizontal amplifier and sweep circuits with normal sensitivity.

It's different because of the extreme vertical amplifier response. Check the featured specifications against others. For TV use wide band response if necessary.

The case is 8" high x 5" wide x 14" long, attractively finished in "hammered" opalescent blue enamel. Operates on standard 110 volts—60 cycles —40 watts. Tubes, 3BP1—6AC7 —6SJ7—6X5—5Y3—884. Instructions included. Complete specifications upon request. Satisfaction or your money back.

PRICE

**\$49.95**

F. O. B. DETROIT

## PUSHBACK WIRE



### BELOW MILL PRICES!

2,000,000 feet—tinned copper—all 1st class, double cotton serve, waxed finish.

Available solid or stranded

22 gauge (6 colors) per 1000 **\$3.98**

20 gauge (6 colors) per 1000 **\$4.98**

18 gauge (brown) per 1000 **\$6.49**

## RADIO SUPPLY & ENGINEERING CO., Inc.

85 SELDEN AVE. DETROIT 1, MICH.

## TELEVISION RECEIVER—\$1.00

Complete instructions for building your own television receiver. 16 pages—11"x17" of pictures, pictorial diagrams, clarified schematics. 17"x22" complete schematic diagram & chassis layout. Also booklet of alignment instructions, voltage & resistance tables and troubleshooting hints.—All for \$1.00.

CERTIFIED TELEVISION LABORATORIES  
Dept. C. 5507-13th Ave., Brooklyn 19, N. Y.

## WANTED

The following old E.I.Co. apparatus:  
E.I.Co. Fixed condenser (in wooden box, with 3 binding posts)  
E.I.Co. 17-Slide plate, variable condenser (with wooden frame)  
E.I.Co. Rotary potentiometer (in black molded case)  
E.I.Co. Plastic radio fixed condenser .0165 mf (with 2 binding posts)  
E.I.Co. double-slide tuner with black molded ends

All above were made between 1905 & 1910  
Please communicate with

H. GERNSBACK  
25 West Broadway, New York 7, N. Y.

First activity of the organization was a meeting at International Business Machines Co. on April 3 to hear a talk by C. W. Torsch of General Electric Co. Mr. Torsch discussed the effectiveness of television r.f. stages.

An FM clinic was held by the Green Bay Servicemen's Association, Green Bay, Wis., last April, reports secretary H. L. Haskins. The clinic was an all-day affair sponsored by two local FM stations, WJPG and WTAQ. Equipment was furnished by leading manufacturers and local parts distributors; alignment demonstrations were held. The Association, in existence for about three years, holds meetings on the first Tuesday of each month, with lectures given by visitors from manufacturers and service data publishers. Membership numbers 85, almost all of whom attend the meetings regularly.

A joint smoker was held on April 20 by the Lackawanna Radio Technicians Association (Pennsylvania) and a group of Luzerne technicians. Committeemen were Austin Renville, Myland Krupa, Wilbur Treet, and Marino Ruggiere of Luzerne and Ernest Ludwig, Merrill Greene, Ferdinand Yax, Howard Greene, and Leon J. Helk of the Lackawanna group. A program of entertainment was presented.

## Radio Thirty-five Years Ago In Gernsback Publications

### HUGO GERNSBACK

#### Founder

Modern Electrics .....	1908
Electrical Experimenter .....	1913
Radio News .....	1919
Science & Invention .....	1920
Television .....	1927
Radio-Craft .....	1929
Short-Wave Craft .....	1930
Television News .....	1931
Wireless Association of America .....	1908

Some of the larger libraries in the country still have copies of ELECTRICAL EXPERIMENTER on file for interested readers.

## JULY 1915 ELECTRICAL EXPERIMENTER

- How to Build a Photophone, by Homer Vanderbilt
- New Arc Radio Sets for Ships
- New Arc for Radio Telephony
- A Wireless Lecture Set
- The Microphonic Radio Amplifone
- New U. S. Radio Receiving Set
- New Wireless Code Teacher
- The Goldschmidt Tone Wheel Detector
- Blowing Up a Toy Boat by Wireless
- Vacation Wireless Receiving Set
- A Rotary Tuning Coil Slider
- The Potato Detector
- Mercury Turbine Interrupter
- Water Sending Condenser
- New Plotron Vacuum Tube

Television juke boxes were introduced by the Solutone Corp., Los Angeles. Made by Hallcrafters Co., Chicago, the device offers six minutes of television or AM programming or phonograph music for a nickel. Small coin boxes distributed about the restaurant or tavern allow patrons to choose one of 10 records, four AM stations or four TV stations.



**COMBINATION TUBE TESTER**  
SET TESTER and CONDENSER TESTER  
— MODEL 802NA —



Tube Tester has speedy leakage-short tests between all elements. Separate noise test for tubes that otherwise test "good." Large scale 4 1/2" meter protected against burn out by special meter fuse for both multimeter and tube tester. Complete unit also protected by separate fuse. Tests new and old types of tubes as well as ballast tubes.

**RANGES**

DC Voltmeter: 0-10-50-500-1000 at 1000 Ohms per Volt.  
AC Voltmeter: 0-10-50-500-1000.  
DC Milliammeter: 0-1-10-100-1000.  
DC Ammeter: 0-10 Amperes.  
Ohmmeter: 0-500-5000 ohms 0-0.1-1-10 Meg. Low center scale.  
DB Meter: -8 to +55 decibels in four ranges.  
Four range output meter: Same as AC volts.  
Model 802NA—supplied in handsome hardwood case, with special compartment for small tools, test leads (Included).  
Size: 12 3/4" x 12" x 5 1/4". Weight: 11 1/2 lbs.  
Complete with self-contained batteries, ready to operate.  
Dealer Net Price **59.50**

**RADIO CITY PRODUCTS CO., INC.**  
152 West 25th St. New York 1, N. Y.

**SAVE**  
at **RADIONIC** the  
House of Radio and Television Buys

- ▶ **MAGNAVOX SPEAKER 17" PM. 8**  
ohm voice coil. Will handle 15 watts. Rare value! **\$4.70**
- ▶ **MAGNAVOX SPEAKER 8" PM. 31 oh.**  
slug. 6-8 ohm voice coil. Remarkable fidelity. Genuine bargain! **\$3.15**
- ▶ **TRANSFORMER RCA model. 720 VCT**  
160 ma., 6.3 VCT or 4 amps 5 V or 3 amps. Shell type. Universal mounting. Shpg. wt.: 7 lbs. **\$2.95**
- ▶ **FILTER CHOKE 4.5 Hy. @ 200 ma.** Open frame mounting. RCA model. Companion piece to above transformer. **\$1.55**

**TUBES** Standard brands up to 80% off. Send for list. **TERMS:** 20% deposit with order, balance COD

**RADIONIC EQUIPMENT COMPANY**

Tribune Theater Entrance  
170L Nassau Street New York 7, N. Y.  
Worth 2-0421 :: Open daily 9 to 6--Saturday 9-5

**FREE! MAIL TODAY!**

GET YOUR COPY AT ONCE!  
of RADIONIC'S Bargain Catalogs, Radio & Television Sets—Parts—Accessories. Unbeatable Values!

RADIONIC EQUIPMENT CO., Dept. 107  
170N Nassau Street, New York 7, N. Y.

Please rush Free Copy of your latest Bargain Catalog of Radio and Television Sets, Parts, Tubes and Accessories.

NAME \_\_\_\_\_  
ADDRESS \_\_\_\_\_ STATE \_\_\_\_\_  
CITY \_\_\_\_\_

... FARNSWORTH GK140-44 CHASSIS

Intermittent reception and poor selectivity on FM are caused by poor ground connections between the FM front-end subassembly and the tuning capacitor, and between the tuning capacitor and chassis. Add at least three flexible bonding straps between the front of the capacitor and chassis and three more between the rear of the capacitor and the FM front-end subassembly. Replace the grounding braids on the drum rotor with heavier ones. Clean and increase tension on capacitor rotor wipers; tighten end bearings.

Complete realignment is necessary because many of these sets left the factory improperly aligned. If i.f. alignment screws stick, do not force them; they break easily. Loosen them with coil-dope thinner applied with a medicine dropper.

H. M. HARVEY,  
Westfield, N. J.

... WESTINGHOUSE H-202 and H-204

An error in the manufacturer's diagram of these models shows C12 and R17 in series between the AM antenna terminal and the top of L17. R17 should connect to the bottom of L17, rather than to the top of L17 as shown.

Westinghouse Service Information No. 1

... PHILCO 48-2500

High-voltage failure in this and other receivers using 1B3 rectifiers can often be traced to poorly soldered connections on the filament pins. These connections make contact when cold and open intermittently when hot. I solve this problem by filing a notch in the side of the filament pins of all 1B3's so the filament leads are exposed. I then apply a non-corrosive soldering paste and fill the holes with solder.

CLARENCE B. JONOS,  
Cleveland, Ohio

... ZENITH 6-S256

Severe distortion in this and similar models can be caused by a leaky capacitor at the output of the filter. If this capacitor is leaky, the current through it passes through the biasing resistors thus developing excess bias voltage on the audio tubes.

OSBORNE E. PORTER,  
W. Somerville, Mass.

... ZENITH TV CHASSIS 28F20

Receivers using chassis 28F20, 21, 22 produce a round picture by increasing the vertical size. This distorts the picture, particularly if the width control will not fill the whole screen when set at maximum—a common fault in these chassis. Connect a .05- to .15-uf capacitor across the width control. This allows plenty of control over the horizontal size. The width control can be advanced until the picture is linear, however, this will cut off its sides. This alteration improves the aspect ratio but does not compensate for the round mask.

JOHN W. TURNER,  
Newark, N. J.

**DON'T TURN THIS PAGE UNTIL YOU SEE THESE RED HOT SPECIALS! THEN COMPARE**

**HIGH FIDELITY**



**FM/AM CUSTOM CHASSIS**

12" long, 10 1/4" deep, 7" high  
Complete with 12" Speaker & Dipole 13 Tubes includes 2-6V6 PP for Power Output, driven by a balanced Phase Inverter circuit consisting of a pair of 6AT6's.—Phono Input & Selector Switch. FM Coverage 8.8 MC—108 MC. AM/540KC-1700 KC. Response: 50 to 10,000 cps (3db down). 105-125 Volts A.C. Underwriters Approved Reg. List \$169.00  
**\$64.50**  
Write for full Specs. ONLY Complete



**Here's a Real Summer Special 3-WAY PORTABLE**

**\$15.95**

NOT A KIT but a factory finished, Top Quality Product. Operates on 110-220 V. AC and 4 Batteries. 4 miniature auto plus selenium rectifier. 4" Alnico 5 Speaker. Uses 1-6, 12 V. and 1-11/2 V. Batteries. Total weight 6 1/2 lbs. Size: 10" x 4 1/2" x 4 1/2". Money back guarantee.

Kit of Batteries for above **\$1.95**

**Here's a SENSATIONAL BUY!**

**Lp 45 RPM & COLUMBIA ATTACHMENT**

Now play both these new records with this low priced, Dual speed attachment. 7 Gram Crystal Pickup complete with Permanent Needle. 110 Volts A.C. **\$14.95**



Lots of 3 **\$13.95**

**PORTABLE PHONOGRAPH KIT-COMplete \$11.95**



We were swamped last month when we ran this special—Best Buy Anywhere—complete, nothing else to buy. 2 Watt Amplifier—5" PM Speaker—Complete Instructions. Factory wired and tested.

**\$13.95**

Lots of 3 **\$12.95**

25% Deposit—Balance C.O.D.

**SALCO ELECTRONIC DIST.**

Box 96 Station W, Brooklyn 11, N. Y.

**New!** highest efficiency of any known D.C. power supply in the 3 to 9 volt range

**MODEL "B" D.C. POWER SUPPLY**



**Look at the Features!**

- New heavy duty selenium rectifiers.
- Eight power tap adjustments.
- 1 to 20 amperes at 6 volts continuous duty.
- Less than 3% A.C. ripple or hum.
- Damped volt and amperes (no wig-gling) Voltmeter 3% accuracy.
- Heavy duty tap switch.
- The RIGHT price.

**WRITE TODAY FOR COMPLETE DETAILS**

**ELECTRO PRODUCTS LABORATORIES, INC.**  
Pioneer Manufacturers of Battery Eliminators

549 W. Randolph St. Chicago 6, Ill.

... EMERSON Model 540A

Strong oscillations were traced to the i.f. amplifier. This set uses miniature tubes. The sockets have metal center inserts grounded through a brass strip to the socket mounting rivet. A short piece of stranded wire soldered between the center insert and ground cleared up the trouble.

RAYMOND H. LEESON,  
Auburn, N. Y.

... PHILCO 49-1075

Trouble in the sweep or sync circuits of this and similar models has, in several instances, been traced to broken leads on the .5- $\mu$ f, 200-volt capacitor between the plate of the 5V4-G damper tube and the horizontal deflection coils. Replace this capacitor with one of equal rating and heavier leads.

DON TSUBOI,  
Los Angeles, Calif.

HUM IN A.C.-D.C. SETS

When hum gets louder as the volume control is turned down, look for a shorted power amplifier tube. The short will not show up on a tester unless the tube is left in the tester long enough for the elements to expand.

PETER BEDROSIAN,  
Newburyport, Mass.

RCA 630TS etc.

When microphonics in the front end of the 630TS—and other sets with the same tuner—cannot be cured by replacing the 6J6's, the trouble may be caused by the 4.7- $\mu$ f capacitors that cross each other under the oscillator socket. Try cementing these capacitors together with a few drops of polystyrene cement.

EDWARD T. HATTRUP,  
South Gate, Calif.

... HALLICRAFTERS S-55, 56

Excessive warmup drift on FM, sufficient to cause the a.f.c. to lose control of a signal, can be cured easily.

Remove the FM oscillator mica trimmer built in the top of the front section of the ganged tuning capacitor. Replace with a ceramic trimmer (5-30  $\mu$ f) having an N750 negative temperature coefficient. Locate the new trimmer at the bottom of the gang capacitor (but above the chassis deck) adjacent to the 6J6. Re-check oscillator alignment on FM.

H. M. HARVEY,  
Westfield, N. J.

... OLD PORTABLE SETS

A number of the older battery portable receivers use A-batteries with binding posts. The filament leads were seldom polarized. If the batteries are inserted incorrectly, distortion will be noted at high volume levels. This happens because the A-batteries are also used for bias, and the positive bias causes distortion. Correct this trouble by reversing the battery connections.

JOSEPH FORTH,  
Washington, D. C.

**WHERE RADIOMEN MEET, EAT and SLEEP**

Visit the FAMOUS FIESTA LOUNGE Renowned for Fine Food



**HOTEL STRAND**

Atlantic City's Hotel of Distinction

The Ideal Hotel for Rest and Relaxation • Beautiful Rooms • Salt Water Baths • Glass enclosed Sun Porches • Open Sun Decks • Prop • Delightful Cuisine • Garage on premises. • Moderate Rate Schedule.

**OPEN ALL YEAR** Exclusive Pennsylvania Ave. and Boardwalk

**Be FIRST!**

with the **16" GLASS TUBE** by **ZETKA**

famous for Quality and Dependability

- ★ Long life
- ★ Flat face
- ★ Ion trap
- ★ 15" and 16" tubes available NOW!

write: **ZETKA TELEVISION TUBES, INC.**  
131 Getty Ave., Clifton, N. J. or phone: PASSaic 2-9095

James J. Sutherland has been appointed general manager of the Electronics Division of Sylvania Electric Products, Inc. Sutherland joined the Sylvania staff at Salem, Mass., in April 1941, as accounting supervisor; from 1944 until his appointment as comptroller of the Electronics Division at Boston in 1947, he served as assistant manager of internal auditing for the Sylvania corporation.



Richard B. Leng has been appointed comptroller of the Electronics Division of Sylvania Electric Products, Inc., it was announced by J. J. Sutherland, general manager of that division. He joined the staff of the director of manufacturing of Sylvania Electric in 1946 and in the following year became manager of production planning and purchasing at the Electronics Plant in Boston.



Everett Gilbert has been promoted to the position of vice-president for engineering at Radio Frequency Laboratories, Inc., Boonton, N. J. With RFL as special projects engineer since 1945, Gilbert was previously employed by General Electric Company as a member of a development group on the Manhattan Project. His accomplishments at RFL include the development of a new electronic metal detector for industrial processing lines. Gilbert graduated from the University of Colorado in 1942 with a B.S. degree in electrical engineering. He is 28 years old.



For The Best in Tape Recorders Look For The TWIN-TRAX\* Label

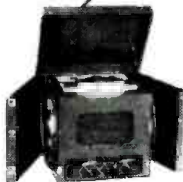

TWIN-TRAX 4-HOUR PLAY



TWIN-TRAX STANDARD



TWIN-TRAX PORTABLE

This label identifies the original and only TWIN-TRAX Recorder, manufactured exclusively by Amplifier Corp. of America. It is your assurance that the recorder bearing this label has the professional specifications that have made TWIN-TRAX the "choice of engineers everywhere."

TWIN-TRAX was the first commercially available two-channel tape recorder. Imitators have announced two-channel recorders with similar names and similar external appearances. But it's the performance that counts, not the appearance. And the performance of TWIN-TRAX recorders cannot be duplicated. Our leadership in the tape recording field has been undisputed since we designed the first magnetic recording amplifier in 1936.

Remember, imitative Twin-Track or Two-Track does not mean TWIN-TRAX, because TWIN-TRAX is the registered trade mark of the best in tape recorders, made exclusively by Amplifier Corp. of America. Send today for literature on the exclusive TWIN-TRAX line, and discover why TWIN-TRAX is the recorder engineers are buying.

\*Registered Trade Mark.

AMPLIFIER CORP. OF AMERICA

398-10 Broadway

New York 13, N. Y.

★★★ SPECIALS ★★★

For Your Mobile Rig!

49c

Threaded Coax Terminal HF/RF Insul. Sily. Pl. Coat. 1/2" dia. 100m. ATC ARH w/ Wabapf. 2500. Range For MOBILE ANT. - BRAND NEW PL25P for above. 35

FISHPOLE ANT.

49c

MS-10 & MS-50-M. HOLE OF DIPLOLE 7.4" White Many Uses. 11 of 1 w/ w. SET Tubes. News. 3 for \$1.29

ROTARY BEAM COUPLER RF Coupler, 360° Rotations. 1 Turn Coupling Link. Plastic Case Mount on Side. Price

\$2.95

AN 130 FLEXIBLE ANTENNA

Price \$1.75



Electrolytic and Paper Condensers

Table with columns: Fig., Mfd., Voltage, Mfrs., Size, Price. Lists various capacitor models and prices.

WRITE FOR LISTS OF MANY OTHERS

- Kit Lugs - Small Radio Type, 300 For \$1.00
Kit Lugs - Large Radio Type, 100 For \$1.00
Kit Trimmer Condensers - Was used as sample kit of various condenser Co. Some list for \$2.50 ea. 4.95
Special

FREE FREE FREE C.E.C. BARGAIN SHEETS OF ITEMS YOU NEED Write Today and Save

Buy with Confidence TRANSFORMERS AND CHOKES



- 115V 60 cy. INPUT (Equiv. Conservatively Rated)
FILAMENT TRANSFORMERS
5V/0A \$2.25; 2.5VCT 0.5A \$3.25

- PLATE TRANSFORMERS
P110-80VCT/40MA, 760VCT/500MA \$6.50
P99V/450MA, \$4.95; 70V/1A 2.25

- COMBINATION TRANSFORMERS
780V/400MA, 6.3/2, \$3.95; 825VCT/100MA, 5VCT/3A \$3.95

- FILTER CHOKES
27HY/55MA, \$1.00; 6HY/150MA \$1.50
Swing 15-20HY/150MA, \$3.25; 8.5HY/125MA \$1.65

WRITE FOR LISTS OF MANY OTHERS COMMUNICATIONS EQUIPMENT COMPANY

BAND PASS FILTER

#70173, Sharp band pass peaked at 700 cps. Bandwidth: 650 cycles at 20 db. Down from peak. High-to-high impedance. Can be plugged into phone output of receiver for good results. Cuts out QRM. New, with circuit diagram \$2.00



HiGain Dyn Mike Xfmr

LINE FILTERS
GE 100 Amp W/285 MFD 50V oil filled cond. 110 VAC. DC \$1.99

METER 4KV., O-1MA MOVE

FILTER DUAL 1 KW. Clean up your HIG & TVL. Easy to mount. Uses 4-6002 Condensers. w/dmg. and cond. Complete \$4.25

INTERPHONE CONTROL BOX

Permits transfer of H.S. from receiver. JK-34A, Toggle Sw. Lum. Tip. Pot. 50.000 Ohm Term. Strip. A Real Buy. Price \$98c

KITS

POWER SUPPLIES BASIC KITS

- Basic 3" and 5" TV Pwr. Supply contains Trans. 1080V/55MA, 6.3V/1.2A, 6.3V/1.2A, 2-1MFD 50V 200V, 2x2 Tube, Socket, 1-100000 ohm Resis. Price \$7.95
Basic 5" and 7" TV Power Supply contains Trans. 2500V/50MA, 2-1MFD 50V 200V, 2-7MFD 60WV Tube, Socket, 1-100000 ohm resis. Price \$9.95

TELEVISION COMPONENTS

- Transformer-300H/55MA, 720VCT/200MA, 6.4V/8.7A, 6.4V/8A, 5V/3A, 1.25V/3A, Full Power Packet for 5" and 7" Scope Supply, Special \$6.95
Transformer-1000V/55MA for 10" and 15" 4.49
Deflection Yoke for 5" to 12" Scope Tube, Fully Cased, Ray 20A \$4.49

WRITE FOR FLYER OF OTHER BUYS

# SUMMER SPECIALS:

**ANTENNA ROTATOR**—Ideal reversible motor for rotating all types of antennas at the top. Weights only 4 1/2 lbs. Size: 7 1/2" L. less shaft. Gear box and Mtg.: 4 1/2" x 3 1/2". Motor size: 5" L. x 2 1/2" D. Shaft size: 3/8" x 1 1/2" threaded. Operates from 24 V. DC, 2 amps. or 30 V.A.C. 4.5 RPM; governor can be adjusted for lowest RPM. Torque: 70 lbs. per inch. Price: **\$8.95** New. **TRANSFORMER** for above item **\$2.95**

**MP-22 MAST BASE** Mounting with spring action and mounting bracket insulated at top to receive modified MS-53 Mast Section listed below. Mast Base only: **\$2.95** **MAST SECTIONS:** For above MP-22, tubular steel, copper coated, painted—in 3 foot sections. Bottom section MS-53 can be used to make any length. MS-52-51-50-49 for taper. Screw-in type. Any section—Price **.50 each**

**TELESCOPING STEEL ANTENNA**—3 Sections 94" long. Telescoped 40". Size: 3/4" to 1/2". Price **\$1.50**

## TRANSFORMERS—110 VOLT 60 CYCLE PRIMARIES:

Sec. 24 Volt 2 amp.	\$2.25
Sec. 14-14 or 28 Volt 7 1/2 or 15 amp.	4.95
Sec. 12 Volt 1 amp.	1.50
Sec. 24 Volt 1 amp.	1.95
Sec. 24 Volt .5 amp.	1.50
Sec. 36 V.A.C. 2.5 amp.	2.95
Sec. 50 V.T.—60 MA 6.3 V. 5 amp., 5 V. 3 amp.	2.45
700 V.T.—60 MA 6.3 V. 4 amp., 5 V. 3 amp.	2.95
NNO V.T.—200 MA 6.3 V. 6 amp., 5 V. 3 amp.	4.75

## COMMAND TRANS. AND RECEIVER TRANSFORMERS—110 V.A.C. 60 CYCLE INPUT

Output: 600-0-600 V.A.C. at 250 MA. 12 V.A.C. at 3 amps.; 12 V.A.C. at 3 amps. & 5 V.A.C. at 3 amps. =RH-108 **\$6.90**  
Output: 250-0-250 V.A.C. at 60 MA. 21 V.A.C. at 6 amp. 6.3 V.A.C. at 6 amp. =RH-109 **\$3.00**

## MOTORS

6 or 12 Volt AC-DC Heavy Duty reversible Motor with 5/16" x 7/16" shaft. Price: New **\$2.95**  
**6 Volt AC-DC Motor**—Ideal for auto. fans, models, etc. Shaft: 1/4" x 7/8". (Tested) **\$1.50**  
**Model Motor**—12 Volt AC-DC 1/2" double end shaft Motor. Size: 2 1/2" L. x 2 1/2" W. x 1 1/2" H. Price: **\$1.50**  
**110 Volt 60 cycle**. Ball Bearing Motor. approx. 3500 RPM. 1/25 H.P. Shaft: 5/16" x 3/8". Motor size: 6 1/2" L. x 4" H. Converted type. Price: **\$2.95**  
**Hand Tool Motor**—12 Volt AC-DC—5600 RPM. 3/4" L. x 1 1/4" Dia. with splined shaft 1/2" D. x 1/4" L. Price: **\$2.95**  
**PHONO MOTOR** only. 110 V. 60 Cycle, for auto. changer **\$1.75**  
**110 Volt 60 cycle Motor**, 1750 RPM for fans or blowers. Size: 3" x 3". Shaft size: 3/16" x 1". Price: **\$2.95**  
Address Dept. RE • Prices—F.O.B., Lima, Ohio • 25% Deposit on C.O.D.'s • Minimum Order \$2.00

## SELSYN TRANSMITTER & INDICATOR SYSTEM

Ideal as radio beam position indicator for lighthouses, Teletelostat, or Commercial use. Complete with 5 inch 1-82 Indicator, Autosyn Trans., 12 Volt 60 cycle Transformer, and wiring instructions. Price **\$7.95** New. **PL-118 PLU: 1/1-82** **\$1.00**



**DYNAMOTOR**—Is your electric shaver in your car? Dynamotor will supply 110 Volt 100 MA from 6 VDC and will operate most types of AC-DC shavers. Normal operation 12 VDC input; 220 Volt 100 MA output **\$1.95**

## DYNAMOTORS:

INPUT:	OUTPUT:	SOCK No:	PRICE:
9 V. DC	450 V. 60 MA	D 9150	\$3.95
w/blower			
12 V. DC	220 V. 100 MA	D 402	3.95
12 V. DC	440 V. 200 MA	D 401	7.95
28 V. DC	F/SCR 522	PE 94	7.95
12/24 V. DC	F No. 19 MARK II	P 8 #3	9.50
13/26 V. DC	F/BC-645	P 8 101	2.95
12/24 V. DC	500 V. 50 MA	D 0515	2.95
28 V. DC	F/Comm. Re- celers	DM 32	1.95
11 V. DC	220 V. 100 MA	DM 20	3.95
12/24 V. DC	440 V. 200 MA— and 220 V. 100 MA	DM 20	9.95
28 V. DC	400 Cycle Inverter	D 104	9.95

**ZIGI SELSYN MOTORS**—Can be used as position indicator for antennas; 110 Volt 60 cycle, with instructions. Normally operates from 57.5 Volts 400 cycle. Price per Pair **\$3.00**  
**SELSYN #C-78248**—115 Volt AC 60 cycle. Size V 3 1/2" x 5 1/2". Can be used to turn small antennas or for position indicator systems. Price per Pair **\$5.95**  
**FT-237 MOUNTING** For BC-601 and 603's and for BC-684 and 683's. New **\$9.95**

## MISCELLANEOUS:

Coaxial Cable—125 OHM Cotton covered—50 Ft. **\$1.00**  
Coaxial Cable—72 OHM Rubber covered—8 Ft. **.50**  
Cable—4 Conductor. Rubber covered, shielded—50 Ft. **2.00**  
Wire—Heavy duty 2 Cond. Rubber covered #11 stranded—20 Ft. **1.00**  
Wire—2 Cond. Rubber covered Tires #16—per Ft. **.06**  
PL-8 Filter 1200 CPS **1.95**  
BC-1200 F Rec. 200-300 KC. DET. 6 tube set **6.95**  
TU-17 of 25 for BC-223 Price New **4.50**  
Cable for BC-223 w PL-50 each end **1.75**  
Cable for BC-375 w PL-61 each end **1.75**  
Cable for TR-84/65ET, 6F10, or 65F13 **2.95**  
Plugs for 1L-21 Tubes PL-112 or PL-108 **1.00**

## People

Floyd Makstein has been appointed television field engineer of Emerson Radio and Phonograph Corporation, New York. Mr. Makstein joined Emerson in January, 1945, upon release from the Armed Services and for several years



worked with the television engineering staff. He was then assigned to the company's subsidiary, Emerson Television Service Corporation, working in its development and organization.

Harry Estersohn has been appointed sales manager of the Jerrold Electronics Corp., Philadelphia, Pa. Mr. Estersohn was formerly sound sales engineer with the Lafayette-Concord Radio Corp. of New York City. After serving 4 years with the U.S. Navy as aviation radioman on antisubmarine duty, Mr. Estersohn came to Lafayette-Concord as copy chief in charge of the catalog department. He also has been associated with Newark Electric and Terminal Radio Corp. both of New York City. Mr. Estersohn is a graduate of the University of Miami.

Edward W. Butler has been appointed director of the Radio Division, Federal Telephone and Radio Corporation, Clifton, N. J., the company announced last month.



Mr. Butler was formerly the general manager of the Electronics Div., Sylvania Electric Prod., Inc.

Raymond S. Perry, formerly president of the Eicor Corporation, Chicago, and previously in charge of sales and engineering of several of the country's large industrial organizations, has been appointed general sales manager, Federal Telephone and Radio Corporation, Clifton, N. J., it was announced by Ellery W. Stone, president. Mr. Perry, a graduate of the Massachusetts Institute of Technology will direct all commercial activities of Federal, American manufacturing associate of the International Telephone and Telegraph Corporation.



Frank W. Guthrie has been appointed sales manager of the Rauland Corp. of Chicago, manufacturers of Visitron aluminumized television picture tubes, according to an announcement made by E. N. Rauland, president. Mr. Guthrie joined the Rauland Corp. in 1944, at which time he served as special assistant to Mr. Rauland in the co-ordination of government contract activities. He was later assigned the position of director of purchases, which he held until his recent appointment. He was formerly with Chevrolet.

# FAIR RADIO SALES 132 SOUTH MAIN ST. LIMA, OHIO

Low FACTORY-TO-YOU Prices

## New! MIDWEST TELEVISION

with BIG 75 Square inch SCREEN

- 12 1/2" PICTURE TUBE
- 12 TELEVISION CHANNELS
- PICTURE-HOLD CONTROL

**EASY TERMS**

Other Models Include: SYMPHONY GRAND AM-FM RADIO-TELEVISION-PHONOGRAPH with DUAL-SPEED RECORD PLAYER

also complete CHASSIS for Console Installation and Adapter Chassis and Console for use with 1947, 1948, 1949 Midwest Radio Models

**30 DAYS TRIAL**

Also Sensational NEW MIDWEST RADIOS with DUAL-SPEED Phonograph

MIDWEST RADIO & TELEVISION CORP. Dept. T-38B, 909 Broadway, Cincinnati, Ohio

Name \_\_\_\_\_

Address \_\_\_\_\_

City \_\_\_\_\_ Zone \_\_\_\_\_ State \_\_\_\_\_

Send for TELEVISION Folder, Prices and NEW 1948 MIDWEST RADIO Catalog

## Miller BUILDERS OF QUALITY RADIO INDUCTANCES SINCE 1924

### THE SENSATIONAL NEW MILLER BAND-PASS TRF TUNER USING A GERMANIUM DIODE DETECTOR



**HIGH FIDELITY**

- NO TUBES!
- NO POWER SUPPLY! • NO HUM!
- A SIMPLE 2 TUNED CIRCUIT NEGATIVE MUTUAL COUPLED BAND PASS TUNER
- EASY TO ASSEMBLE & WIRE!

In spite of its simplicity, low cost: #585 kit is not a toy.—It is a carefully designed High Fidelity Broadcast band tuner. Use it with your amplifier and speaker system for truly high quality reception.

The audio output of the tuner is proportional to the input signal and will vary from .05V to .5V for stations within a 20-25 mile radius when used with a good antenna of from 75 to 100 feet in length. A good antenna is absolutely essential to the proper operation of the #585 tuner.

The net price of the Miller #585 TRF tuner kit, including chassis, dial, and tuning condenser, is only \$11.40. The additional parts required make it possible to build the complete tuner at a net cost of less than \$15.00.

Order yours now—ask for the new MILLER—Cat. No. 585 Crystal Detector Tuner—Net \$11.40

SEE YOUR LOCAL RADIO PARTS SUPPLIER FOR THE MILLER #585 KIT AND OTHER MILLER PRODUCTS—INCLUDING THE COILS USED IN THE HIGH FIDELITY TUNER IN THIS ISSUE.

**MILLER QUALITY PRODUCTS**

**J. W. MILLER COMPANY**  
5917 S. MAIN ST. LOS ANGELES, CALIF.

**OUT-FIPSES FIPS**

Dear Editor:

I experimented with Mohammed U. Fips' magnetic enlarger (April issue, page 34) and found why it did not work. He could not project the electron stream to the enlarging screen because a vacuum was required in the intervening space.

I enclosed the space in a sheet-metal casing and applied a heavy coat of liquid rubber to all the seams to stop air leakage. I made a hole 2 1/4 inches in diameter to which I fitted my vacuum-cleaner hose.

When all was ready, I turned on the TV set and enlarger rectifier and then kicked the switch of the vacuum cleaner. As the air was drawn out of the casing, a picture appeared on the enlarging screen—first faint, then brilliant and beautifully defined.

Filled with triumph, I held a demonstration the next evening for several of my friends. Again I turned on the set, then pushed the vacuum-cleaner switch; the picture, faint at first, grew to full brilliancy. I blinked at what I saw—thought my eyes were playing tricks on me—then stared in horror, along with all my friends.

Right there on that 30 x 40-inch screen was a bevy of girls doing a classical dance. At times they seemed quite normal. But every few seconds their clothes became almost transparent. And sometimes there—well, there just weren't any clothes.

I didn't know what to do. I looked at my guests, then muttered, "Something must be wrong—no station is sending out a program that way." I switched to other channels, and each time the performer's clothes faded away.

"Well," I said, "I'll be doggoned if I can explain it . . . unless. . . . I think I've got it!

"In television"—I reasoned aloud as I went along—"there is a condition that permits you to see through an object. You must have noticed it on your sets—you can sometimes see a rope right through a wrestler or a venetian blind through a person standing in front of it. It's an out-of-phase condition called X-ray effect. I must have something out of phase."

Quickly I made a test. I reversed the vacuum cleaner's a.c. line plug. In came the program again, normal in every way—everyone fully dressed. To prove I had found the answer, I reversed the line plug again and—

"Hold it, everybody. This is a pinch!" I snapped my head up and standing over me was a big, burly policeman; guarding the door was another.

"So!" said the large-size boy in blue, taking a good look at the screen. "The report was true! We have a place for people who show indecent pictures."

Well, it looks like a nice day outside; the sun is streaming in through the bars. My only regret is that Mohammed Ulysses Fips, that half-baked pseudo-scientist, isn't in here with me.

Do you think I'll get out soon?  
VINCENT GALE,  
Springfield Gardens, N.Y.

# SPECIAL RADIO TUBE SALE!

## AM, FM, TV Tubes

**34 1/2¢ each**

1B3	1T4	7E6
6J6	1U4	10
6AG5	3A4	12A
6AK5	3Q4	12A8GT
6AL5	5U4G	12AT6
6AQ5	5V4	12BA6
6AV6	5Y3GT	12BE6
6BD6	6A3	12F5
6BG6G	6ABGT	12H6
6BH6	6AT6	12K7GT
6BJ6	6BA6	12SA7GT
6B8GT	6BE6	12SG7
6SN7GT	6C4	12SH7GT
6SS7	6C5GT	12SJ7GT
6T8	6F6GT	12SK7GT
6Z7G	6G6	12SN7GT
12AU7	6K6GT	12SQ7GT
12A7	6P5GT	12SR7
12AX7	6SA7GT	14X7
12BA7	6SD7GT	20
12SB	6SJ7GT	25L6GT
19T8	6SL7GT	25Z6GT
2C34	6SK7GT	32L7GT
2E24	6SQ7GT	35
4A6G	6U7GT	35B5
01A	6V6GT	35C5
1L4	6X4	35W4
1R5	6X5GT	24A
1S5	7B6	38
		1J6G

## KEN RADS

**49¢ ea.**

1A5GT	6F5	7A4
1P5GT	6F8G	7E7
1T5GT	6H6	7L7
1V	6J7	7T7
1C5GT	6K7G	12A7
2A5	6D6	12J5
2A7	6F5	12Q7
5X4	6S7	12SF7
6B8	6U7	12SG7
6C6	6T7G	2050
6D8	6W7G	2051
		24A

ALL AMERICAN 5 KIT—\$2.69  
RCA, Hyman, Tungsol, Sylvania  
50L6, 35Z5, 12SA7, 12SK7, 12SQ7. **\$2.69**

## Summer Specials!

**59¢ ea.**

1A5GT	1L5	12Z3
1L84	1Q5GT	43
1LC5	6S7	
1LH4	11Z6	

## Summer Specials!

**49¢ ea.**

0Z4	1N5GT	7G7
1A7GT	7A4	7H7
1G4GT	7A7	7J7
1H5GT	7F7	7N7

Minimum Order \$5.00. Add 5¢ per tube for orders of less than 100. Tubes may be assorted in mixed price categories. All ships F.O.B. Chicago. 25% deposit with order, balance C.O.D. ALL MERCHANDISE BRAND NEW and individually boxed. Foreign Inquiries Invited.

## CONCERT MASTER RADIO TUBE COMPANY 1802 WINNEMAC AVENUE CHICAGO 40, ILL.

# T. A. C. DOES IT First AGAIN!

All Major Components Already Mounted on Chassis

including pre-wired "VIVIDeo" I. F. strip (Pat. Pend.) and pre-wired front end. Only 13 tubes remain to be wired! No technical knowledge required!

NEW! SIMPLIFIED INSTRUCTIONS! COMPLETE SERVICE DATA! The most elaborately detailed instructions in television even a layman can follow.

CABINETS AND STANDS IN BLOND AND WALNUT AVAILABLE AT REASONABLE PRICES. WRITE FOR LITERATURE.

**FREE!..** Complete comprehensive Service Data on the T.A.C. exclusive "VIVIDeo" 13-tube Picture and Sound I.F. Strip (Pat. Pend.). Contains all information needed to thoroughly understand and service this unique high-gain I.F. Strip which features 5 1/2 stages of Cathode-Coupled Grounded-Grid Video I.F. amplification. For high gain, sensitivity, stability, "VIVIDeo" can't be beat! Write for FREE booklet SB-1 or ask your local jobber for it. Booklet SB-1 also included with each T.A.C. Direct-View Assembly.

### NEW LOW PRICES!

**T.A.C. STANDARD MODELS** 20 RCA tubes, plus RCA or DuMont C.R. tube, pre-wired "VIVIDeo" 13-tube Picture and Sound I.F. Strip with 5 1/2 stages of Picture Amplification, Pre-wired All-channel Front End with Fine Tuning, RCA 5X7 (or Heavy Duty PM) Speaker, Delivered complete with ALL MAJOR COMPONENTS MOUNTED. PLUS New Comprehensive 81 PER-SIMPLIFIED DATA for Wiring and Servicing.  
Model M101S—Complete (less C.R. Tube) **\$169.50** Dealer's Net\*  
Model F101S—Complete with 10" RCA C.R. Tube **\$203.50** Dealer's Net\*  
Model F121S—Complete with 12" DuMont C.R. Tube **\$231.25** Dealer's Net\*  
Model F151S—Complete with 15" DuMont C.R. Tube **\$314.50** Dealer's Net\*

**T.A.C. CHAMPION MODELS.** Identical extra-value features as above except Standard Tuner replaced by DuMont Tuner for Continuous Tuning of ALL FM RADIO AND TV CHANNELS.  
Model M101C—Complete (less C.R. Tube) **\$209.50** Dealer's Net\*  
Model F101C—Complete with 10" RCA C.R. Tube **\$243.75** Dealer's Net\*  
Model F121C—Complete with 12" DuMont C.R. Tube **\$271.40** Dealer's Net\*  
Model F151C—Complete with 15" DuMont C.R. Tube **\$357.35** Dealer's Net\*  
Model F201C—Complete with 20" DuMont C.R. Tube **\$566.75** Dealer's Net\*

ALL T. A. C. 15" and 20" Assemblies contain 20 RCA tubes, plus DuMont C.R. tube, RCA 12" Heavy Duty PM speaker, and all features mentioned above PLUS Pre-wired 1KV High Voltage Doubler Power Supply.

★ Write for Catalog on our Complete Line of TV Replacement Components! Prices subject to change without notice.

**540 BUSHWICK AVE., BROOKLYN 6, N. Y.**



Prices 5% Higher West of the Mississippi

Model P-520 . . . 520 Sq. In. Screen Projection Television Assembly. Wonderful LARGE PICTURE TELEVISION with a 20x26 In. screen. Dealer's Net\* . . . **\$769.50**

All components are of the finest quality and fully guaranteed under the Standard RMA Guarantee. All TAC Assemblies are guaranteed to operate when assembled according to instructions.

# RADIO SCHOOL DIRECTORY



Become an **ELECTRICAL ENGINEER!**

**MAJOR IN ELECTRONICS**



### B. S. DEGREE... IN 36 MONTHS

Make one of the most important decisions of your life—today! Capitalize on your electronic interests—decide to become an Electrical Engineer. Choose, also, to save a valuable year by earning your Bachelor of Science Degree here in 36 months of intensive study.

This 46-year-old, non-profit Technical Institute offers a world-famous course in Electrical Engineering with a major in Electronics. You follow an industry-guided program which is constantly attuned to current developments. It presents a solid background in the basic sciences . . . Chemistry, Physics, Mathematics, Economics and Electrical Engineering subjects . . . plus 19 technical specialty courses in Engineering Electronics, including four courses in Electronic Design.

Practical, military or academic training will be evaluated for advanced credit.

#### ELECTRONIC TECHNICIAN

At the end of the first year of study of the Electrical Engineering course, the student is qualified as an Electronic Technician.

#### RADIO-TELEVISION TECHNICIAN

To young men interested specifically in radio and television: Prepare here for a career in television—the field which business leaders predict will be among America's top ten industries by 1951. In 18 months you become a Radio-Television Technician, ready for positions in receiver and transmitting testing, servicing, sales, supervision and production.

Because of this school's concentric curriculum, the Bachelor of Science degree in Electrical Engineering (Electronics major) may be earned in 24 additional months.

• • •

A SPECIAL PREPARATORY PROGRAM is offered for men lacking high school diplomas.

TRAIN in modern, well-equipped laboratories, shops and classrooms. Faculty of 85 specialists—over 1500 students and 30,000 graduates.



FALL TERM OPENS OCT. 3

Electrical Engineering	36 months
Electronics Major	
Electronic Technician	12 months
Radio-Television Technician	18 months

## MILWAUKEE SCHOOL OF ENGINEERING

Founded 1903 by Oscar Werwath

Send Coupon for free 48-page Pictorial Bulletin "Your Career" and 110-page Catalog.

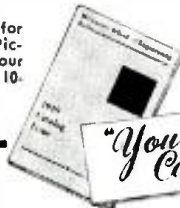

MILWAUKEE SCHOOL OF ENGINEERING  
Dept. RE-749, N. Broadway and E. State, Milwaukee, Wis.

Without obligation send me the Bulletin, "Your Career," and your catalog. I am interested in \_\_\_\_\_ course.

NAME \_\_\_\_\_ AGE \_\_\_\_\_  
ADDRESS \_\_\_\_\_  
CITY \_\_\_\_\_ STATE \_\_\_\_\_ ( ) Veteran of World War II



## RADIO COURSES

Preparatory Mathematics, Service, Broadcast, Television, Marine Operating, Aeronautical, Frequency Modulation, Radar.

C. asses now 4 m.m.; 101 th. fall term Oct. 1st  
Entrance 227. Sept. 19th

**Veterans. Literature.**

**COMMERCIAL RADIO INSTITUTE**  
(Founded 1920)  
38 West Bidale Street, Baltimore 1, Md.

## Make Your Career RADIO and TV

In no other industry does the future hold brighter financial promise and security than in AM and FM Radio, Television. These fields need and want men trained as announcers, script writers, disc jockeys, and radio technicians. It will pay you to investigate the Don Martin School of Radio Arts, established in 1937, complete day and night classes . . . the latest equipment . . . and a staff of 30 nationally known instructors. Over 97% of the combination men graduates are placed on jobs immediately through the free placement service. Approved for veterans.

FREE—Write for Free Booklet "Your Future in Radio."

**Don Martin School of Radio Arts**

1655 No. Chrooke, Hollywood, Calif. HUdson 23281

## TELEVISION NEW, INTERESTING TECHNICAL CAREER

As Television gains momentum, rapidly, constantly, it offers to properly-trained technicians careers with a future in Industry, Broadcasting or own Business.

Train at an Institute that pioneered in TELEVISION TRAINING since 1938.

Morning, Afternoon or Evening Sessions in laboratory and theoretical instruction, under guidance of experts, covering all phases of Radio, Frequency Modulation, Television, Licensed by N. Y. State. Free Placement Service. Approved for Veterans.

**ENROLL NOW FOR NEW CLASSES**  
Visit, Write or Phone

## RADIO-TELEVISION INSTITUTE

480 Lexington Ave., N. Y. 17 (46th St.)  
Plaza 3-4585 2 blocks from Grand Central



## JOBS IN TELEVISION

YOUNG MEN 16 TO 60

There is a Job Opening for Every Qualified Trained Television Technician

### WE CAN TRAIN YOU

Free Employment Service

Visit Our Modern Laboratories and Class Rooms

APPROVED UNDER G. I. BILL OF RIGHTS

### AMERICAN RADIO INSTITUTE

New York Buffalo, N. Y. Syracuse, N. Y.  
101 W. 63 St. 640 Main St. 131 Shonnard St.

"Teaching Radio Since 1935"

## RADIO ENGINEERING

FM—Television—Broadcast

Police Radio, Marine Radio, Radio Servicing, Aviation Radio and Ultra High mobile applications. Thorough training in all branches of Radio and Electronics. Modern laboratories and equipment. Old established school. Ample housing facilities. 7 acre campus. Small classes, enrollments limited. Our graduates are in demand. Write for catalog.

Approved for Veterans

**VALPARAISO TECHNICAL INSTITUTE**  
Dept. C VALPARAISO, INDIANA

## LEARN RADIO!

PREPARE FOR A GOOD JOB!  
COMMERCIAL OPERATOR (CODE)  
RADIO SERVICEMAN  
TELEVISION SERVICING  
BROADCAST ENGINEER

V.A. Furnishes Books and Tools

SEND FOR FREE LITERATURE

**BALTIMORE TECHNICAL INSTITUTE**  
1425 Eataw Place, Dept. C, Baltimore 17, Md.

### AUDIO ENGINEERING SCHOOL

A Practical Audio Engineering course in Sound Fundamentals: Disc, Film and Magnetic Recording; Transmission Measurements; Monitoring and Mixing. Laboratories contain Transmission Sets, Oscillators; Harmonic Analyzer, Distortion Sets, Intermodulation Analyzer, and other equipment. Recording Studio simulating Broadcast, Motion Pictures and Commercial Sound Recording. H. M. Tremaine, Pres., Director. Approved for Veterans and Foreign Visas.

**HOLLYWOOD SOUND INSTITUTE, Inc.**  
1040-E North Kenmore Hollywood 27, Calif.

**RCA RADIO and TELEVISION**  
 Thorough Training in All Technical Phases  
 APPROVED FOR VETERANS  
 DAYS-EVENING WEEKLY RATES  
**RCA GRADUATES ARE IN DEMAND**  
 For Free Catalog Write Dept. RC-45  
**RCA INSTITUTES, Inc.**  
 A Service of Radio Corporation of America  
 350 WEST 4TH STREET NEW YORK 14, N. Y.

**SHORT CUT** **CODE SPEED**  
 Be an Expert  
 Learn to be a Telegrapher or Radio Operator. Thousands of men needed. Immediately interesting work. Earn pay. Learn at home or wherever you are. Available easily with the famous Candler Code Speed System. Quality for amateur or commercial license. Book of particulars free.  
**CANDLER SYSTEM CO.**  
 Dept. 3-H, Box 928 Denver 1, Colo.

**ELECTRICAL TRAINING**  
 Intensive 32 weeks' residence course in fundamentals of industrial electrical engineering, including radio, electronics. Prepares for technician, engineering aides. Approved for veteran training. 56th year. Enter Sept. 6, Jan. 9. Catalog.  
**BLISS ELECTRICAL SCHOOL**  
 7547 TAKOMA AVENUE  
 WASHINGTON 12, D. C.

**RADIO ENGINEERING I**  
 DEGREE IN 27 MONTHS  
 Complete Radio Engineering Course. Bachelor of Science Degree. Courses also in Civil, Electrical, Mechanical, Chemical, Aeronautical Engineering; Business Administration, Accounting, Secretarial Science. Graduates successful. 66th year. Enter Jan., March, June, Sept. Write for catalog.  
**TRI-STATE COLLEGE** 2479 College Ave., ANGOLA INDIANA

**PEN-OSC-LITE**  
 Extremely convenient test oscillator for all radio servicing; alignment • Small as a pen • Self powered • Range from 700 cycles audio to over 600 megacycles u.h.f. • Output from zero to 125 v. • Low in cost • Used by Signal Corps • Write for information.  
**GENERAL TEST EQUIPMENT**  
 38 Argyle Ave. Buffalo 9, N. Y.

**LEARN Electricity OR Radio-Television**  
 IN THE GREAT SHOPS OF **COYNE**  
**TRAIN QUICKLY! OLDEST, BEST EQUIPPED SCHOOL OF ITS KIND IN U.S.**  
 2 Opportunity Fields  
 Come to the Great Shops of COYNE in Chicago during our 50th Anniversary Year. Get quick, practical training in RADIO-TELEVISION or ELECTRICITY. U.S. Dept. of Labor Approved. Entrance plan for non-veterans. **Mail Coupon Today for complete details.**  
**NOT "HOME-STUDY" COURSES!**  
 You learn on real, full-size equipment, not by mail. Finest staff of trained instructors to help you get ready quickly for a better job, a fine future.  
**FREE BOOKS** Clip coupon for big illustrated Coyne book on either ELECTRICITY or RADIO-TELEVISION. Both books sent FREE if you wish. No obligation; no salesman will call. Act NOW!  
 B. W. COOKE, Pres.  
**COYNE Electrical & Radio School, Dept. 89-81H**  
 500 S. Paulina Street, Chicago 12, Illinois  
 Send FREE BOOK and full details on:  
 ELECTRICITY  RADIO-TELEVISION  
 NAME.....  
 ADDRESS.....  
 CITY..... STATE.....

**TOO MUCH TELEVISION**  
*Dear Editor:*  
 I have been a radio repairman since 1930. During those years I have not missed buying many issues of your magazine. But the last four or five issues have been of little benefit to me. They have had far more articles about television than about radio. That might be all right for the fourth of the country that is served by television, but how about the other three-quarters? We are over 90 miles from any city of 50,000 or more. There is very little likelihood of our having a TV station within the next 10 years. And there are thousands of RADIO-ELECTRONICS readers in the same fix.

Recently I wrote to my nephew, who works in a repair shop in Philadelphia, a city with several television stations. He replied that his shop had repaired only seven video sets during 1948! This must average about one TV set to every thousand radio receivers, taking the nation as a whole.

Why use half to three-quarters of a good magazine to print articles covering so small a fraction of reader interest?

WILLIAM KRIDER,  
 Buster Springs, Kans.

**OUR REPLY**

The main reason for our greater attention to television is that it is a *new* subject, one about which the radioman has a great deal to learn. It is up to a progressive magazine to print articles on a subject like this, information not usually to be obtained from other sources.

But we have not gone overboard on television. Our January issue, for instance, contained a 5-page television section—only 5.2% of the total pages in the magazine. In February, television took up five pages—around 4.2%. And in April, again, five pages was the extent of the TV content. The March issue ran quite a bit more than the others, but you would expect a special television issue to do so.

The May issue has about 12 pages, roughly 12.5%. If you discount about half the pages in the magazine for advertising and so on (actually it's less), the May issue is the first in which we have approached the 25% figure you mention.

Your nephew apparently works in one of the repair shops that do not pay much attention to television. Some of the Philadelphia shops get practically all their income from TV installation and servicing—we know of a few that do not even accept sound receivers. There are, of course, others who stick pretty well to sound sets, and some run about half and half.

No one doubts that there is plenty of servicing to do on the million televisers in American homes—and that there will be twice as much during the next year. We feel that our television coverage should reflect this wide interest, so it is unlikely that we will reduce it much.—*Editor*

**WE SCOOP THE MARKET FOR RADIO TUBES!**

And offer them to you at a fraction of list price, here are JULY SPECIALS

1LD5	Sylvania	.37
1Q5	Kenrad	.59
1V	Kenrad	.49
2X2	Nat. Union	.49
5X4	Cunningham	.49
6ZY5	Cunningham	.49
6G6	Philco	.49
6H6	Kenrad	.39
6K6	Tungsol	.39
6V6	Crosley	.69
6R7	Kenrad	.49
7Y4	Sylvania	.39
12Z3	Cunningham	.59
12SG7	Western Elec.	.39
12SR7	Kenrad	.29
35W4	Hytron	.34
35Z5	Kenrad	.39
50L6	Kenrad	.55
43	Kenrad	.69
56	Philco	.39
76	Philco	.29
80	Westinghouse	.39
9002	R.C.A.	.29
K55B	Hytron	.29
VR105	R.C.A.	.59

IF YOU HAVE ANY EXCESS RADIO TUBES WE WILL BUY THEM FROM YOU. SEND LIST, CASH WAITING.

**BROOKS RADIO DIST. CORP.**  
 80 VESEY ST., DEPT. A, NEW YORK 7, N. Y.

**TECH-MASTER BUILDS FASTER!**  
 CIRCUIT ALIGNED COMPONENTS!  
 Proved the only satisfactory method for Quality Results  
**Tech-Master** Deluxe 630 TV Kit Genuine RCA 630 TS Circuit!  
 Only **168.50**  
 Complete Kit Less Kinescope  
 It doesn't take a master to build Tech-Master. Comes 98% assembled. A few enjoyable evenings to finish it up—plug it in and there's your picture. See Tech-Master today — at leading jobber's everywhere.  
 Write for name of nearest jobber.

**TECH-MASTER PRODUCTS CO.**  
 443 Broadway, Dept. E-7, New York 13

**FIX-A-PIX**  
 Improved, Adjustable Matching Strip with instructions. Improves television reception 10 to 200%. Use it for finding correct match at antenna or on receiver. Price \$1.00, postpaid in U.S.A.  
**I. E. COMPANY**  
 730 E. Sample South Bend 18, Ind.





**INDUSTRIAL ELECTRONICS AND CONTROL.** by Royce Gerald Kloeffler. Published by John Wiley & Sons, Inc., New York. 6 x 9 1/2 inches. 478 pages. Price \$5.50.

Though Professor Kloeffler's preface indicates that the book has been written for college engineering students who are not communications majors, its readership should by no means be so limited. Most of the text is devoted to descriptions of the basic components and phenomena used for industrial control, but the first nine chapters make an excellent introduction to general electronics for anyone with a basic knowledge of general physics. The electron theory and its application to electron tubes is covered in these chapters in sufficient detail to impart a useful knowledge of the subject.

The remainder of the volume is given to typical industrial subjects—servo-mechanisms, high-frequency heating, welding, precipitation, control devices, X-rays, and so on. In each case, the topic is explained fairly thoroughly—with specific mathematical analyses where they seem indicated—so that the reader emerges with an excellent idea of both qualitative and quantitative industrial electronics.

The book is especially useful to the radioman who may know much of communication but nothing of non-communication aspects of his field. He will find on every page devices and circuits he can grasp with ease but which perform duties and are used in ways that will give him much of interest to think about.—*R.H.D.*

**DIRECT CURRENT FUNDAMENTALS.** by Joseph J. De France. Published by Prentice-Hall, Inc., New York. 6 x 8 1/2 inches. 279 pages. Price \$4.30.

Most elementary books on radio contain a section on d.c. Too many of these sections are abbreviated to make room for the more advanced material. The novice who, after going through this book, is unable to chase electrons going in one direction, build voltage dividers and ohmmeters, calculate current, voltage, and power distribution in multipath resistive circuits, and cope with any simple d.c. problem, simply cannot read.

The language is conversational, the illustrations clear and numerous, and every calculation clearly explained and driven home with examples.—*R.H.D.*

**WORLD RADIO HANDBOOK FOR LISTENERS.** including Who's Who in the World Radio. Published and edited by O. Lund Juhansen, Copenhagen, Denmark (distributed in the United States by Ben E. Wilbur, East Orange, N. J.). Heavy paper covers. 6 1/2 x 8 1/2 inches. 96 pages. Price \$1.25.

Probably the only complete log of international broadcast stations, this little book is important to all shortwave listeners. Divided into geographical areas, it shows all the shortwave stations of the world and the medium- and long-wave stations of Europe, North Africa and the Near East.

Addresses of the broadcasting companies or administrations are given, as well as the names and titles of leading

figures in the companies. Frequency, wavelength, and power are given, as well as permanent schedules and a certain amount of program information. Musical signatures of the stations which use them are also printed.

The book is put out in two editions—Winter and Summer. The edition reviewed was the November-May 1948-1949 number, and the publisher stated that the next edition would be out early in May, 1949.

**MOST-OFTEN-NEEDED 1949 RADIO DIAGRAMS AND SERVICING INFORMATION.** compiled by M. N. Beitman. Published by Supreme Publications, Chicago. 6 1/2 x 11 inches, 160 pages. Price \$2.50.

This manual is prepared in the same familiar style as the others in the Most-Often-Needed series. It contains schematic diagrams of approximately 390 different receiver models made by some 39 manufacturers. Alignment data, voltage and resistance charts, and dial-stringing diagrams are included with the diagrams of many of the models.—*R.F.S.*

**PATENT LAW.** by Chester H. Biesterfeld. Published by John Wiley & Sons, Inc., New York. 6 x 9 1/2 inches, 267 pages. Price \$4.00.

Almost every American, it has been said, pictures himself at one time or another as an inventor. Certainly this is doubly true for electronic engineers, technicians, and experimenters. This book is a source of information for the inventor, giving him the wherewithal to make a shrewd and informed judgment as to the patentability of his invention and the procedures he should follow.

Many factors must be considered in determining whether an invention has really been made—novelty, priority, originality, possible breadth of claims. And after an application is in, interferences, licensing, and many other problems plague the inventor. After the patent is issued he must deal with such matters as infringements, assignments, and all kinds of litigation.

Mr. Biesterfeld has covered all these subjects in detail and understandably. Recognizing that many facets of patent law are matters of interpretation and judgment rather than strict rule, he has cited and commented upon a large number of actual cases, though without the dryness common to legal works.—*R. H. D.*

**Earn the big pay of an expert radioman**

This self-study **BASIC RADIO COURSE** trains you at home



**EXPLAINS** the principles of operation of vacuum tubes, their basic circuits and other essentials of radio  
**PROVIDES** the electrical background you must have  
**FILLS IN** the radio and electrical mathematics you need, taking you in easy steps from simple fractions to logarithms

Let this self-study course prepare you right at home for a successful future in the radio field. It contains all the information you need... radio—electrical—mathematical—to handle all types of radio sets, test equipment and electronic devices. Explains everything from time delay circuits to the most recent advances in the field... mechanical and wire recording sound systems—frequency modulation—multiunit and multi-electrode tubes, etc.

**A 3-Way Set!**

Even as you learn the fundamentals of radio work you absorb the practical electricity and electrical theory you need. And as you go along the set bills in the mathematics you must know... gives you the essentials of algebra, geometry, trigonometry.

This basic course includes...  
 1. ESSENTIALS OF RADIO by Morris Slurzberg and William Osterheld  
 2. ELECTRICAL ESSENTIALS OF RADIO by M. Slurzberg and W. Osterheld  
 3. MATHEMATICS ESSENTIAL TO ELECTRICITY AND RADIO by Nelson Cooke and Joseph Orleans  
 Over 1,000 illustrations! 1953 pages! 29 appendices!

McGraw-Hill Book Co., 330 W 42 St., NYC 18

Send me your 3-volume BASIC RADIO COURSE for 10 days' examination on approval. In 10 days I will send \$4.95 and \$3.00 a month until I have paid \$13.95, or return the books.

Name \_\_\_\_\_  
 Address \_\_\_\_\_  
 City \_\_\_\_\_ Zone \_\_\_\_\_ State \_\_\_\_\_  
 Company \_\_\_\_\_  
 Position \_\_\_\_\_ RC-7-49  
 Books sent on approval in U. S. and Canada only.

## EASY TO LEARN CODE

It is easy to learn or increase speed with an Instructograph Code Teacher. Attains the quickest and most practical method yet developed. For beginners or advanced students. Available tapes from beginner's alphabet to typical messages on all subjects. Speed range 5 to 40 WPM. Always ready no QRM.



**ENDORSED BY THOUSANDS!**

The Instructograph Code Teacher friendly takes the place of an operator-instructor and enables anyone to learn and master code without further assistance. Thousands of successful operators have acquired the code with the Instructograph System. Write today for convenient trial and purchase plans.

## INSTRUCTOGRAPH COMPANY

4701 Sheridan Rd., Dept. RC, Chicago 40, Ill.

**ATTENTION Amateurs-Experimenters-Inventors**

Cut your cost on radio supplies and equipment in half. Clip coupon today.

Hundreds of "hard to get" war surplus items along with the best in standard brand equipment—all at great savings to you. Let us know your particular requirements. IMMEDIATE DELIVERY.

PLEASE PUT MY NAME ON YOUR MAILING LIST FOR SPECIAL BULLETINS.

NAME \_\_\_\_\_  
 ADDRESS \_\_\_\_\_ ZONE \_\_\_\_\_  
 CITY \_\_\_\_\_ STATE \_\_\_\_\_

**NIAGARA RADIO SUPPLY CORP.**  
 160 Greenwich St., New York City 6, N. Y.

**GREYLOCK RADIO TUBE BARGAINS!**

GT, Glass and Miniature Types

1R5	35A	6SA7GT	12S7GT	} 34 1/2¢
1S5	3V4	6SJ7GT	12SK7	
1T4	6AT6	6SK7GT	12SQ7	} each in 100 lots
1U4	6BA6	6SQ7GT	25Z6GT	
3Q4	6BE6	12SA7	25L6GT	

**SPECIAL OFFER!** All above types may be purchased in lots of 100 assorted. Also available in smaller quantities at 39¢ each.

6AK5	49¢ ea.	6BG6G	.....69¢
6AB5		183-8016	.....89¢
616		2E24	.....\$1.89

All tubes in individual cartons  
 TERMS: Net C.O.D., F.O.B. NYC. MINIMUM ORDER \$5.00.  
 Write for Bargain Catalog C-7  
**Greylock Electronics Supply Co.**  
 30 Church Street New York 7, N. Y.



# HICKOK

610-A

The only complete  
**TELEVISION**

Generator  
*with*

**SELF-CONTAINED  
MARKERS**

*makes your*  
**TV SERVICING**

**RAPID**

**ACCURATE**

**PROFITABLE**



## Features

FOR TODAY AND THE FUTURE

1. Complete frequency coverage.
2. Variable, self-contained markers.
3. Crystal markers, any frequency, modulated or unmodulated.
4. Outstandingly stable.
5. High output.
6. Excellent attenuation.
7. Enables you to align any TV receiver independent of any local station. This generator is complete, and will remain up-to-date for a long time to come.

WITH THE HICKOK MODEL 610

*you can*

- ✓ Align I.F.
- ✓ Align R.F.
- ✓ Align Oscillators
- ✓ Align Traps
- ✓ Insert Markers (3 types)  
Oscillator, Absorption,  
Crystal
- ✓ Cover all TV channels

Thousands of the HICKOK Model 610 have been in use by leading technicians for over a year.

THE HICKOK ELECTRICAL INSTRUMENT CO. 10531 Dupont Avenue CLEVELAND 8, OHIO

Please send me full details on the complete new HICKOK 600 series Television test equipment, including the brand-new Linearity Pattern Generator.

NAME \_\_\_\_\_

STREET & NO. \_\_\_\_\_

CITY \_\_\_\_\_

ZONE \_\_\_\_\_

STATE \_\_\_\_\_

**MORE FOR YOUR MONEY**

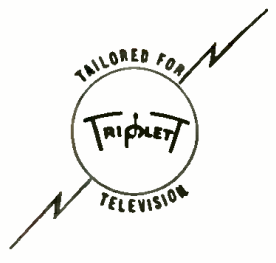

# NEW TV SWEEP GENERATOR-MARKER

**Covers All TV Picture and Sound I.F. and F.M. Ranges**

**MIRROR-SCALED for ACCURACY!**

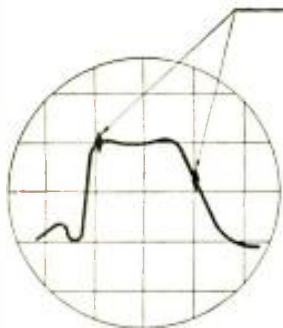

**Two Built-in Markers Can Be Used Simultaneously Giving Facilities for Faster Identification of Bandpass of Curves Without Constant Tuning of Marker**

**Model 3434 Only \$149<sup>50</sup>**

Suggested USA Dealer Net (crystals not supplied)

**TECH DATA**

Frequency Coverage:	
<ul style="list-style-type: none"> <li>• SWEEP CENTER FREQUENCY           <ul style="list-style-type: none"> <li>Range 1— 0-60 MC</li> <li>Range 2— 60-120 MC</li> <li>Range 3—120-240 MC</li> </ul> </li> <li>• SWEEP WIDTH: 0-12 MC (Continuously Variable)</li> <li>• MARKER FREQUENCY 19.5 to 40 MC (fundamental). 39 MC to 240 MC (harmonic)</li> </ul>	<ul style="list-style-type: none"> <li>• CRYSTAL FREQUENCIES To 20 MC on Fundamentals. Harmonics up to 216 MC. (Crystals Not Furnished)</li> <li>• MODULATION 400 Cycle on both Crystal and Marker Frequencies</li> <li>• AUDIO: 400 cycles</li> </ul>

Above also furnished in separate units . . . Sweep Generator . . . Variable Marker . . . Crystal Marker.

*Precision first...to Last*



The new Triplet TV-FM Sweep Generator-Marker, with two built-in Markers and large mirrored dial, was "Tailored For Television" with YOU in mind! The two Markers can be used simultaneously . . . gives you the facilities for faster identification of bandpass of curves without constant tuning of Marker. Marker has both pip and absorption dip control.

The large Marker dial is mirrored for easy reading and greater reset accuracy. Straight line frequency tuning condensers used to provide linear scale markings.

No gaps in frequency . . . continuously variable Sweep width control. Audio output for quick check on video and sound amplifiers.

Expertly-engineered shielding . . . all critical circuits enclosed. Copper plated steel construction.

Contained in attractive black suede finish steel case, size 15-11/32" x 11-1/32" x 8 1/4" . . . leather handle . . . copper-plated feet for grounding when working on metal work bench top . . . panel is black, white and red etched on aluminum.

**For Detailed Information**

See your Radio Parts Distributor or write . . .

**TRIPLET ELECTRICAL INSTRUMENT COMPANY • BLUFFTON, OHIO, U.S.A.**

In Canada: Triplet Instruments of Canada, Georgetown, Ontario

Prices slightly higher west of Rockies